

art

POWER CARRYING SOLUTIONS



AĞIR HİZMET & STANDART TİP KABLO KANALLARI

HEAVY DUTY & MEDIUM TYPE CABLE TRAYS

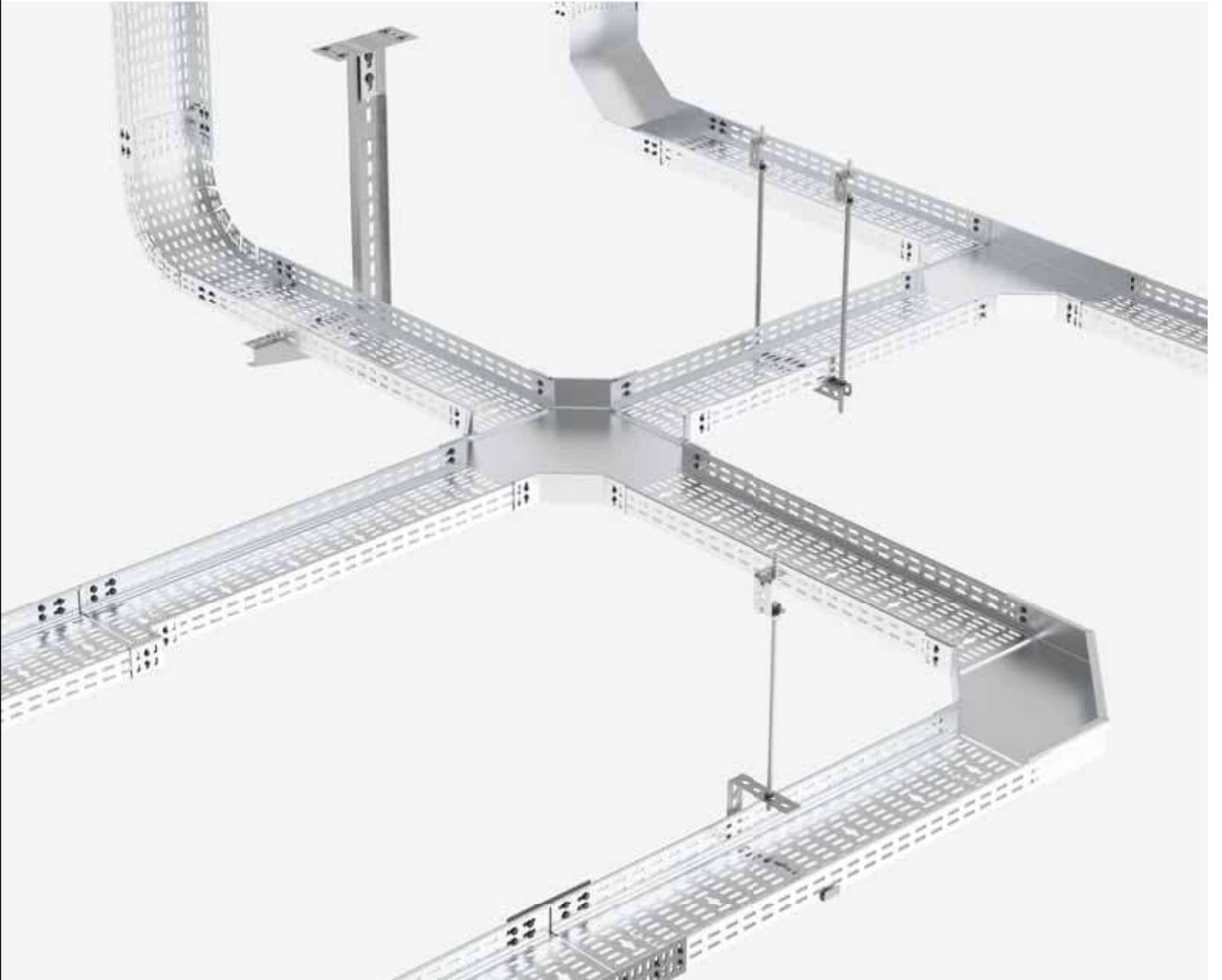

H40 AGH SERIES

AGIR HIZMET TIP KABLO KANALI

HEAVY DUTY TYPE CABLE TRAYS

PREGALVANIZ (PG)
PREGALVANIZED (PG)
TS EN 10346

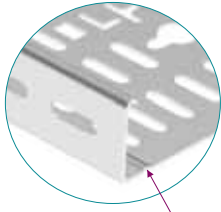

Güçlendirilmiş Büküm
Reinforced Bending

0.80 mm

Sipariş Kodu Order Code	W (mm)	T (mm)	Ağırlık (kg/m) Weight (kg/m)	Barkod Kodu Barcode Code
40 AGH 050-08	50	0.80 mm	0,779	2000301
40 AGH 100-08	100	0.80 mm	1,284	2000304
40 AGH 120-08	120	0.80 mm	1,132	2000382
40 AGH 160-08	160	0.80 mm	1,320	2000383
40 AGH 200-09	200	0.90 mm	1,877	2000310

1.00 mm

Sipariş Kodu Order Code	W (mm)	T (mm)	Ağırlık (kg/m) Weight (kg/m)	Barkod Kodu Barcode Code
40 AGH 050-10	50	1.00 mm	0,967	2000384
40 AGH 100-10	100	1.00 mm	1,282	2000385
40 AGH 120-10	120	1.00 mm	1,415	2000386
40 AGH 160-10	160	1.00 mm	1,650	2000387
40 AGH 200-10	200	1.00 mm	1,878	2000388
40 AGH 300-10	300	1.00 mm	2,470	2000313

1.20 mm

Sipariş Kodu Order Code	W (mm)	T (mm)	Ağırlık (kg/m) Weight (kg/m)	Barkod Kodu Barcode Code
40 AGH 050-12	50	1.20 mm	1,161	2000302
40 AGH 100-12	100	1.20 mm	1,539	2000305
40 AGH 120-12	120	1.20 mm	1,699	2000389
40 AGH 160-12	160	1.20 mm	1,980	2000308
40 AGH 200-12	200	1.20 mm	2,254	2000311
40 AGH 300-12	300	1.20 mm	2,965	2000314
40 AGH 400-12	400	1.20 mm	3,067	2000317
40 AGH 500-12	500	1.20 mm	3,690	2000320

1.50 mm

Sipariş Kodu Order Code	W (mm)	T (mm)	Ağırlık (kg/m) Weight (kg/m)	Barkod Kodu Barcode Code
40 AGH 050-15	50	1.50 mm	1,455	2000303
40 AGH 100-15	100	1.50 mm	1,926	2000306
40 AGH 120-15	120	1.50 mm	1,982	2000390
40 AGH 160-15	160	1.50 mm	2,480	2000309
40 AGH 200-15	200	1.50 mm	2,818	2000312
40 AGH 300-15	300	1.50 mm	3,709	2000315
40 AGH 400-15	400	1.50 mm	4,601	2000318
40 AGH 500-15	500	1.50 mm	5,493	2000321
40 AGH 600-15	600	1.50 mm	6,390	2000322

2.00 mm

Sipariş Kodu Order Code	W (mm)	T (mm)	Ağırlık (kg/m) Weight (kg/m)	Barkod Kodu Barcode Code
40 AGH 050-20	50	2.00 mm	1,974	2000391
40 AGH 100-20	100	2.00 mm	2,613	2000392
40 AGH 120-20	120	2.00 mm	2,689	2000393
40 AGH 160-20	160	2.00 mm	3,365	2000394
40 AGH 200-20	200	2.00 mm	3,824	2000395
40 AGH 300-20	300	2.00 mm	4,944	2000316
40 AGH 400-20	400	2.00 mm	6,135	2000319
40 AGH 500-20	500	2.00 mm	7,326	2000408
40 AGH 600-20	600	2.00 mm	8,511	2000409
40 AGH 700-20	700	2.00 mm	10,066	2000451
40 AGH 800-20	800	2.00 mm	11,334	2000452
40 AGH 900-20	900	2.00 mm	12,601	2000453

40 AGH 100 - 10

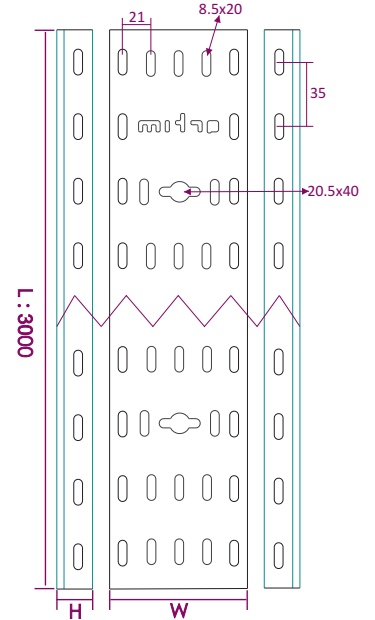
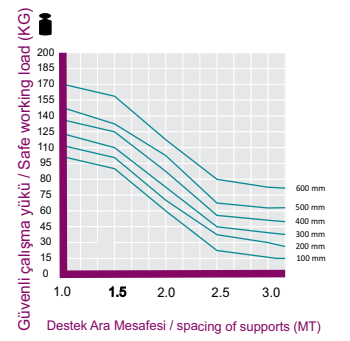

Standart uzunluk L:3000 mm
Toplu miktarlarda Özel ölçüler yapılabilir.
Standard Length L:3000 mm
Custom sizes can be made in bulk quantities.

ARTIM METAL ELEKTRİK A.Ş.

H = YÜKSEKLİK = HEIGHT / W = GENİŞLİK = WIDTH / T = KALINLIK = THICKNESS

* Farklı kalınlık ve ölçülerde üretim yapılabılır.
* Malzeme ağırlıkları yaklaşık değerlerdir, ± %10 değişiklik gösterebilir.
* Malzeme kalınlık toleransı ± %10 dur.
* Lütfen siparişlerinizde sipariş kodu veya ürün kodu ve Kaplama şeklini belirtiniz.

* We can produce cable trays different thickness and dimensions
* Cable trays are shown approximately weight, they could change ± %10 difference.
* Cable trays thickness tolerances are shown ± %10 .
* Please indicate order code and coating type in your orders.

H40 AGH SERIES

AGIR HIZMET TIP KABLO KANALI

HEAVY DUTY TYPE CABLE TRAYS

SICAK DALDIRMA (SD)
HOT DIP GALVANIZED (HDG)
TS EN ISO 1461

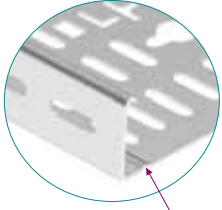

Güçlendirilmiş Büküm
Reinforced Bending

0.80 mm

Sipariş Kodu Order Code	W (mm)	T (mm)	Ağırlık (kg/m) Weight (kg/m)	Barkod Kodu Barcode Code
40 AGH 050-08	50	0.80 mm	0,996	2000301
40 AGH 100-08	100	0.80 mm	1,107	2000304
40 AGH 120-08	120	0.80 mm	1,222	2000382
40 AGH 160-08	160	0.80 mm	1,453	2000383
40 AGH 200-09	200	0.90 mm	1,652	2000310

1.00 mm

Sipariş Kodu Order Code	W (mm)	T (mm)	Ağırlık (kg/m) Weight (kg/m)	Barkod Kodu Barcode Code
40 AGH 050-10	50	1.00 mm	1,245	2000384
40 AGH 100-10	100	1.00 mm	1,384	2000385
40 AGH 120-10	120	1.00 mm	1,528	2000386
40 AGH 160-10	160	1.00 mm	1,817	2000387
40 AGH 200-10	200	1.00 mm	2,065	2000388
40 AGH 300-10	300	1.00 mm	2,720	2000313

1.20 mm

Sipariş Kodu Order Code	W (mm)	T (mm)	Ağırlık (kg/m) Weight (kg/m)	Barkod Kodu Barcode Code
40 AGH 050-12	50	1.20 mm	1,495	2000302
40 AGH 100-12	100	1.20 mm	1,661	2000305
40 AGH 120-12	120	1.20 mm	1,834	2000389
40 AGH 160-12	160	1.20 mm	2,181	2000308
40 AGH 200-12	200	1.20 mm	2,479	2000311
40 AGH 300-12	300	1.20 mm	3,263	2000314
40 AGH 400-12	400	1.20 mm	3,376	2000317
40 AGH 500-12	500	1.20 mm	4,062	2000320

1.50 mm

Sipariş Kodu Order Code	W (mm)	T (mm)	Ağırlık (kg/m) Weight (kg/m)	Barkod Kodu Barcode Code
40 AGH 050-15	50	1.50 mm	1,507	2000303
40 AGH 100-15	100	1.50 mm	2,122	2000306
40 AGH 120-15	120	1.50 mm	2,139	2000390
40 AGH 160-15	160	1.50 mm	2,729	2000309
40 AGH 200-15	200	1.50 mm	3,102	2000312
40 AGH 300-15	300	1.50 mm	4,082	2000315
40 AGH 400-15	400	1.50 mm	5,062	2000318
40 AGH 500-15	500	1.50 mm	6,042	2000321
40 AGH 600-15	600	1.50 mm	7,032	2000322

2.00 mm

Sipariş Kodu Order Code	W (mm)	T (mm)	Ağırlık (kg/m) Weight (kg/m)	Barkod Kodu Barcode Code
40 AGH 050-20	50	2.00 mm	2,045	2000391
40 AGH 100-20	100	2.00 mm	2,879	2000392
40 AGH 120-20	120	2.00 mm	2,903	2000393
40 AGH 160-20	160	2.00 mm	3,703	2000394
40 AGH 200-20	200	2.00 mm	4,209	2000395
40 AGH 300-20	300	2.00 mm	5,439	2000316
40 AGH 400-20	400	2.00 mm	6,752	2000319
40 AGH 500-20	500	2.00 mm	8,061	2000408
40 AGH 600-20	600	2.00 mm	9,364	2000409
40 AGH 700-20	700	2.00 mm	11,073	2000451
40 AGH 800-20	800	2.00 mm	12,467	2000452
40 AGH 900-20	900	2.00 mm	13,861	2000453

H = YÜKSEKLİK = HEIGHT / W = GENİŞLİK = WIDTH / T = KALINLIK = THICKNESS

40 AGH 100 - 10

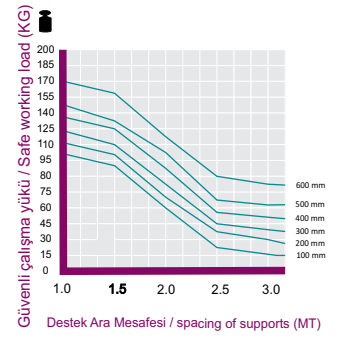

Güvenli çalışma yükü / Safe working load (KG)
Destek Ara Mesafesi / spacing of supports (MT)

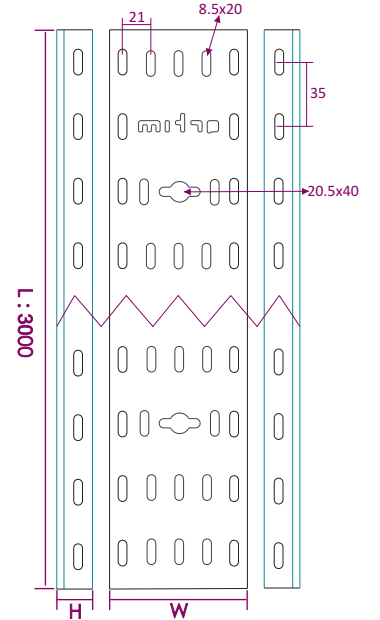

Standart uzunluk L:3000 mm
Toplu miktarlarda Özel ölçüler yapılabilir.
Standard Length L:3000 mm
Custom sizes can be made in bulk quantities.

* Farklı kalınlık ve ölçülerde üretim yapılabılır.
* Malzeme ağırlıkları yaklaşık değerlerdir, \pm %10 değişiklik gösterebilir.
* Malzeme kalınlık toleransı \pm %10 dur.
* Lütfen siparişlerinizde sipariş kodu veya ürün kodu ve Kaplama şeklini belirtiniz.

* We can produce cable trays different thickness and dimensions
* Cable trays are shown approximately weight, they could change \pm %10 difference.
* Cable trays thickness tolerances are shown \pm %10 .
* Please indicate order code and coating type in your orders.

H40 AGH SERIES

AGIR HIZMET TIP KABLO KANALI (DELIKSIZ)

HEAVY DUTY TYPE CABLE TRAYS (NON PERFORATED)

PREGALVANIZ (PG)
PREGALVANIZED (PG)
TS EN 10346

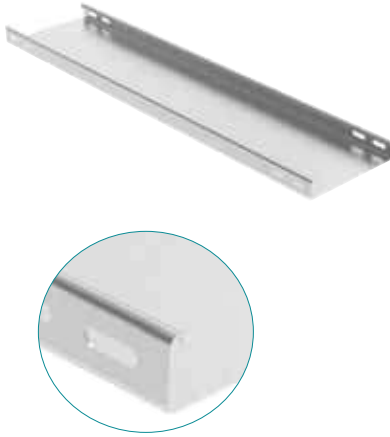

0.80 mm

Sipariş Kodu Order Code	W (mm)	T (mm)	Ağırlık (kg/m) Weight (kg/m)	Barkod Kodu Barcode Code
40 AGH 050-08D	50	0.80 mm	0,896	2000301
40 AGH 100-08D	100	0.80 mm	1,476	2000304
40 AGH 120-08D	120	0.80 mm	1,302	2000382
40 AGH 160-08D	160	0.80 mm	1,518	2000383
40 AGH 200-09D	200	0.90 mm	2,158	2000310

1.00 mm

Sipariş Kodu Order Code	W (mm)	T (mm)	Ağırlık (kg/m) Weight (kg/m)	Barkod Kodu Barcode Code
40 AGH 050-10D	50	1.00 mm	1,112	2000384
40 AGH 100-10D	100	1.00 mm	1,474	2000385
40 AGH 120-10D	120	1.00 mm	1,627	2000386
40 AGH 160-10D	160	1.00 mm	1,897	2000387
40 AGH 200-10D	200	1.00 mm	2,159	2000388
40 AGH 300-10D	300	1.00 mm	2,840	2000313

1.20 mm

Sipariş Kodu Order Code	W (mm)	T (mm)	Ağırlık (kg/m) Weight (kg/m)	Barkod Kodu Barcode Code
40 AGH 050-12D	50	1.20 mm	1,335	2000302
40 AGH 100-12D	100	1.20 mm	1,770	2000305
40 AGH 120-12D	120	1.20 mm	1,954	2000389
40 AGH 160-12D	160	1.20 mm	2,277	2000308
40 AGH 200-12D	200	1.20 mm	2,592	2000311
40 AGH 300-12D	300	1.20 mm	3,410	2000314
40 AGH 400-12D	400	1.20 mm	3,527	2000317
40 AGH 500-12D	500	1.20 mm	3,690	2000320

1.50 mm

Sipariş Kodu Order Code	W (mm)	T (mm)	Ağırlık (kg/m) Weight (kg/m)	Barkod Kodu Barcode Code
40 AGH 050-15D	50	1.50 mm	1,673	2000303
40 AGH 100-15D	100	1.50 mm	2,215	2000306
40 AGH 120-15D	120	1.50 mm	2,279	2000390
40 AGH 160-15D	160	1.50 mm	2,852	2000309
40 AGH 200-15D	200	1.50 mm	3,241	2000312
40 AGH 300-15D	300	1.50 mm	4,265	2000315
40 AGH 400-15D	400	1.50 mm	5,291	2000318
40 AGH 500-15D	500	1.50 mm	6,317	2000321
40 AGH 600-15D	600	1.50 mm	7,349	2000322

2.00 mm

Sipariş Kodu Order Code	W (mm)	T (mm)	Ağırlık (kg/m) Weight (kg/m)	Barkod Kodu Barcode Code
40 AGH 050-20D	50	2.00 mm	2,270	2000391
40 AGH 100-20D	100	2.00 mm	3,005	2000392
40 AGH 120-20D	120	2.00 mm	3,092	2000393
40 AGH 160-20D	160	2.00 mm	3,870	2000394
40 AGH 200-20D	200	2.00 mm	4,398	2000395
40 AGH 300-20D	300	2.00 mm	5,686	2000316
40 AGH 400-20D	400	2.00 mm	7,055	2000319
40 AGH 500-20D	500	2.00 mm	8,425	2000408
40 AGH 600-20D	600	2.00 mm	9,788	2000409
40 AGH 700-20D	700	2.00 mm	11,842	2000451
40 AGH 800-20D	800	2.00 mm	13,334	2000452
40 AGH 900-20D	900	2.00 mm	14,825	2000453

40 AGH 100 10D

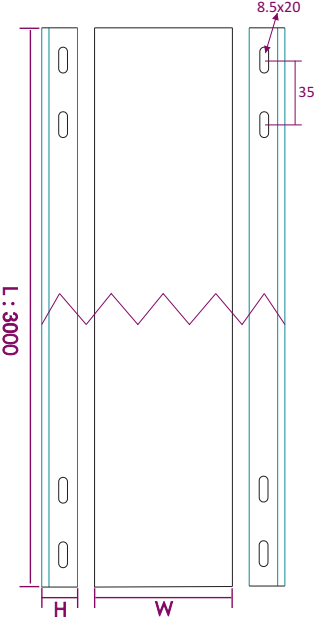
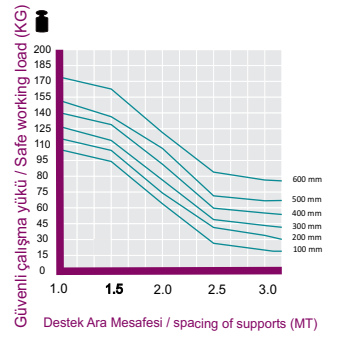

Standart uzunluk L:3000 mm
Toplu miktarlarda Özel ölçüler yapılabilir.
Standard Length L:3000 mm
Custom sizes can be made in bulk quantities.

ARTIM METAL ELEKTRİK A.Ş.

H = YÜKSEKLİK = HEIGHT / W = GENİŞLİK = WIDTH / T = KALINLIK = THICKNESS

* Farklı kalınlık ve ölçülerde üretim yapılabılır.
* Malzeme ağırlıkları yaklaşık değerlerdir, ± %10 değişiklik gösterebilir.
* Malzeme kalınlık toleransı ± %10 dur.
* Lütfen siparişlerinizde sipariş kodu veya ürün kodu ve Kaplama şeklini belirtiniz.

* We can produce cable trays different thickness and dimensions
* Cable trays are shown approximately weight, they could change ± %10 difference.
* Cable trays thickness tolerances are shown ± %10 .
* Please indicate order code and coating type in your orders.

H40 AGH SERIES

AGIR HIZMET TIP KABLO KANALI (DELİKSİZ)

HEAVY DUTY TYPE CABLE TRAYS (NON PERFORATE)

SICAK DALDIRMA (SD)
HOT DIP GALVANIZED (HDG)
TS EN ISO 1461

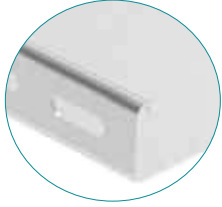

0.80 mm

Sipariş Kodu Order Code	W (mm)	T (mm)	Ağırlık (kg/m) Weight (kg/m)	Barkod Kodu Barcode Code
40 AGH 050-08D	50	0.80 mm	1,145	2000301
40 AGH 100-08D	100	0.80 mm	1,273	2000304
40 AGH 120-08D	120	0.80 mm	1,405	2000382
40 AGH 160-08D	160	0.80 mm	1,671	2000383
40 AGH 200-09D	200	0.90 mm	1,900	2000310

1.00 mm

Sipariş Kodu Order Code	W (mm)	T (mm)	Ağırlık (kg/m) Weight (kg/m)	Barkod Kodu Barcode Code
40 AGH 050-10D	50	1.00 mm	1,432	2000384
40 AGH 100-10D	100	1.00 mm	1,592	2000385
40 AGH 120-10D	120	1.00 mm	1,757	2000386
40 AGH 160-10D	160	1.00 mm	2,090	2000387
40 AGH 200-10D	200	1.00 mm	2,375	2000388
40 AGH 300-10D	300	1.00 mm	2,720	2000313

1.20 mm

Sipariş Kodu Order Code	W (mm)	T (mm)	Ağırlık (kg/m) Weight (kg/m)	Barkod Kodu Barcode Code
40 AGH 050-12D	50	1.20 mm	1,719	2000302
40 AGH 100-12D	100	1.20 mm	1,910	2000305
40 AGH 120-12D	120	1.20 mm	2,109	2000389
40 AGH 160-12D	160	1.20 mm	2,508	2000308
40 AGH 200-12D	200	1.20 mm	2,851	2000311
40 AGH 300-12D	300	1.20 mm	3,752	2000314
40 AGH 400-12D	400	1.20 mm	3,882	2000317
40 AGH 500-12D	500	1.20 mm	4,062	2000320

1.50 mm

Sipariş Kodu Order Code	W (mm)	T (mm)	Ağırlık (kg/m) Weight (kg/m)	Barkod Kodu Barcode Code
40 AGH 050-15D	50	1.50 mm	1,733	2000303
40 AGH 100-15D	100	1.50 mm	2,440	2000306
40 AGH 120-15D	120	1.50 mm	2,460	2000390
40 AGH 160-15D	160	1.50 mm	3,138	2000309
40 AGH 200-15D	200	1.50 mm	3,567	2000312
40 AGH 300-15D	300	1.50 mm	4,694	2000315
40 AGH 400-15D	400	1.50 mm	5,821	2000318
40 AGH 500-15D	500	1.50 mm	6,948	2000321
40 AGH 600-15D	600	1.50 mm	8,087	2000322

2.00 mm

Sipariş Kodu Order Code	W (mm)	T (mm)	Ağırlık (kg/m) Weight (kg/m)	Barkod Kodu Barcode Code
40 AGH 050-20D	50	2.00 mm	2,352	2000391
40 AGH 100-20D	100	2.00 mm	3,311	2000392
40 AGH 120-20D	120	2.00 mm	3,338	2000393
40 AGH 160-20D	160	2.00 mm	4,258	2000394
40 AGH 200-20D	200	2.00 mm	4,840	2000395
40 AGH 300-20D	300	2.00 mm	6,255	2000316
40 AGH 400-20D	400	2.00 mm	7,765	2000319
40 AGH 500-20D	500	2.00 mm	9,270	2000408
40 AGH 600-20D	600	2.00 mm	10,769	2000409
40 AGH 700-20D	700	2.00 mm	13,026	2000451
40 AGH 800-20D	800	2.00 mm	14,667	2000452
40 AGH 900-20D	900	2.00 mm	16,308	2000453

H = YÜKSEKLİK = HEIGHT / W = GENİŞLİK = WIDTH / T = KALINLIK = THICKNESS

40 AGH 100 10D

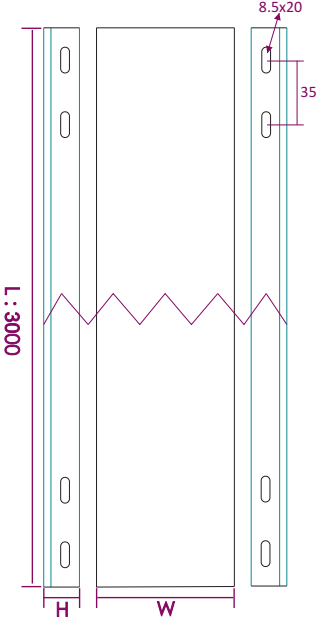
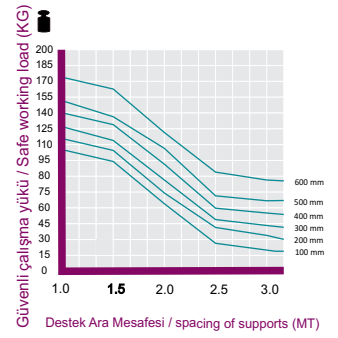

Standart uzunluk L:3000 mm
Toplu miktarlarda Özel ölçüler yapılabilir.
Standard Length L:3000 mm
Custom sizes can be made in bulk quantities.

* Farklı kalınlık ve ölçülerde üretim yapılabılır.
* Malzeme ağırlıkları yaklaşık değerlerdir, \pm %10 değişiklik gösterebilir.
* Malzeme kalınlık toleransı \pm %10 dur.
* Lütfen siparişinizde sipariş kodu veya ürün kodu ve Kaplama şeklini belirtiniz.

* We can produce cable trays different thickness and dimensions
* Cable trays are shown approximately weight, they could change \pm %10 difference.
* Cable trays thickness tolerances are shown \pm %10 .
* Please indicate order code and coating type in your orders.

H40 AST SERIES

STANDART TIP KABLO KANALI

MEDIUM DUTY CABLE TRAYS

SICAK DALDIRMA (SD)
HOT DIP GALVANIZED (HDG)
TS EN ISO 1461

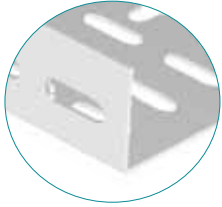

0.80 mm

Sipariş Kodu Order Code	W (mm)	T (mm)	Ağırlık (kg/m) Weight (kg/m)	Barkod Kodu Barcode Code
40 AST 050-08	50	0.80 mm	0,863	2000101
40 AST 100-08	100	0.80 mm	1,003	2000142
40 AST 120-08	120	0.80 mm	1,109	2000143
40 AST 160-08	160	0.80 mm	1,584	2000144
40 AST 200-09	200	0.90 mm	1,724	2000145

1.00 mm

Sipariş Kodu Order Code	W (mm)	T (mm)	Ağırlık (kg/m) Weight (kg/m)	Barkod Kodu Barcode Code
40 AST 050-10	50	1.00 mm	1,078	2000146
40 AST 100-10	100	1.00 mm	1,254	2000104
40 AST 120-10	120	1.00 mm	1,387	2000107
40 AST 160-10	160	1.00 mm	1,980	2000108
40 AST 200-10	200	1.00 mm	1,916	2000110

1.20 mm

Sipariş Kodu Order Code	W (mm)	T (mm)	Ağırlık (kg/m) Weight (kg/m)	Barkod Kodu Barcode Code
40 AST 050-12	50	1.20 mm	1,209	2000102
40 AST 100-12	100	1.20 mm	1,499	2000105
40 AST 120-12	120	1.20 mm	1,664	2000147
40 AST 160-12	160	1.20 mm	2,318	2000109
40 AST 200-12	200	1.20 mm	2,288	2000111
40 AST 300-12	300	1.20 mm	3,087	2000113

1.50 mm

Sipariş Kodu Order Code	W (mm)	T (mm)	Ağırlık (kg/m) Weight (kg/m)	Barkod Kodu Barcode Code
40 AST 050-15	50	1.50 mm	1,617	2000103
40 AST 100-15	100	1.50 mm	1,877	2000106
40 AST 120-15	120	1.50 mm	1,941	2000148
40 AST 160-15	160	1.50 mm	2,704	2000149
40 AST 200-15	200	1.50 mm	2,871	2000112
40 AST 300-15	300	1.50 mm	3,861	2000114
40 AST 400-15	400	1.50 mm	4,846	2000116
40 AST 500-15	500	1.50 mm	5,841	2000118
40 AST 600-15	600	1.50 mm	6,826	2000120

2.00 mm

Sipariş Kodu Order Code	W (mm)	T (mm)	Ağırlık (kg/m) Weight (kg/m)	Barkod Kodu Barcode Code
40 AST 050-20	50	2.00 mm	1,940	2000150
40 AST 100-20	100	2.00 mm	2,547	2000151
40 AST 120-20	120	2.00 mm	2,634	2000152
40 AST 160-20	160	2.00 mm	3,669	2000153
40 AST 200-20	200	2.00 mm	3,896	2000154
40 AST 300-20	300	2.00 mm	5,145	2000115
40 AST 400-20	400	2.00 mm	6,458	2000117
40 AST 500-20	500	2.00 mm	7,786	2000119
40 AST 600-20	600	2.00 mm	9,099	2000121
40 AST 700-20	700	2.00 mm	10,921	2000454
40 AST 800-20	800	2.00 mm	12,332	2000455
40 AST 900-20	900	2.00 mm	13,742	2000456

H = YÜKSEKLİK = HEIGHT / W = GENİŞLİK = WIDTH / T = KALINLIK = THICKNESS

40 AST 100-10

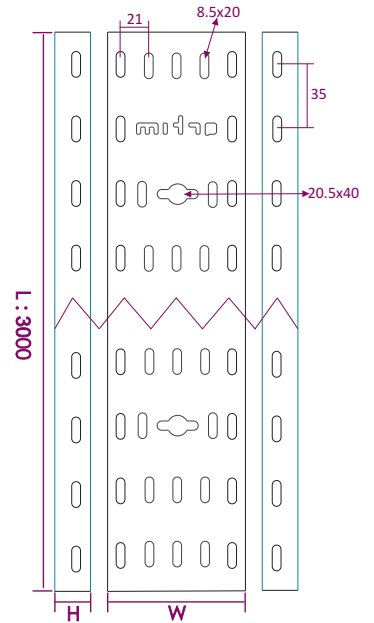
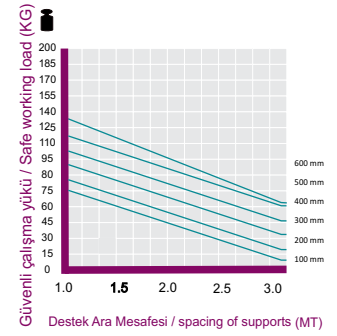

Standart uzunluk L:3000 mm
Toplu miktarlarda Özel ölçüler yapılabilir.
Standard Length L:3000 mm
Custom sizes can be made in bulk quantities.

* Farklı kalınlık ve ölçülerde üretim yapılabılır.
* Malzeme ağırlıkları yaklaşık değerlerdir, \pm %10 değişiklik gösterebilir.
* Malzeme kalınlık toleransı \pm %10 dur.
* Lütfen siparişlerinizde sipariş kodu veya ürün kodu ve Kaplama şeklini belirtiniz.

* We can produce cable trays different thickness and dimensions
* Cable trays are shown approximately weight, they could change \pm %10 difference.
* Cable trays thickness tolerances are shown \pm %10 .
* Please indicate order code and coating type in your orders.

H40 AST SERIES

STANDART TIP KABLO KANALI

MEDIUM DUTY CABLE TRAYS

PREGALVANİZ (PG)
PREGALVANİZ (PG)
TS EN 10346

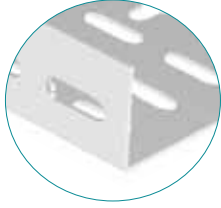

0.80 mm				
Sipariş Kodu Order Code	W (mm)	T (mm)	Ağırlık (kg/m) Weight (kg/m)	Barkod Kodu Barcode Code
40 AST 050-08	50	0.80 mm	0,657	2000101
40 AST 100-08	100	0.80 mm	0,910	2000142
40 AST 120-08	120	0.80 mm	1,007	2000143
40 AST 160-08	160	0.80 mm	1,438	2000144
40 AST 200-09	200	0.90 mm	1,566	2000145

1.00 mm				
Sipariş Kodu Order Code	W (mm)	T (mm)	Ağırlık (kg/m) Weight (kg/m)	Barkod Kodu Barcode Code
40 AST 050-10	50	1.00 mm	0,821	2000146
40 AST 100-10	100	1.00 mm	1,137	2000104
40 AST 120-10	120	1.00 mm	1,259	2000107
40 AST 160-10	160	1.00 mm	1,561	2000108
40 AST 200-10	200	1.00 mm	1,740	2000110

1.20 mm				
Sipariş Kodu Order Code	W (mm)	T (mm)	Ağırlık (kg/m) Weight (kg/m)	Barkod Kodu Barcode Code
40 AST 050-12	50	1.20 mm	1,109	2000102
40 AST 100-12	100	1.20 mm	1,362	2000105
40 AST 120-12	120	1.20 mm	1,511	2000147
40 AST 160-12	160	1.20 mm	1,873	2000109
40 AST 200-12	200	1.20 mm	2,078	2000111
40 AST 300-12	300	1.20 mm	2,803	2000113

1.50 mm				
Sipariş Kodu Order Code	W (mm)	T (mm)	Ağırlık (kg/m) Weight (kg/m)	Barkod Kodu Barcode Code
40 AST 050-15	50	1.50 mm	1,230	2000103
40 AST 100-15	100	1.50 mm	1,705	2000106
40 AST 120-15	120	1.50 mm	1,888	2000148
40 AST 160-15	160	1.50 mm	2,342	2000149
40 AST 200-15	200	1.50 mm	2,607	2000112
40 AST 300-15	300	1.50 mm	3,508	2000114
40 AST 400-15	400	1.50 mm	4,405	2000116
40 AST 500-15	500	1.50 mm	5,307	2000118
40 AST 600-15	600	1.50 mm	6,203	2000120

2.00 mm				
Sipariş Kodu Order Code	W (mm)	T (mm)	Ağırlık (kg/m) Weight (kg/m)	Barkod Kodu Barcode Code
40 AST 050-20	50	2.00 mm	1,640	2000150
40 AST 100-20	100	2.00 mm	2,273	2000151
40 AST 120-20	120	2.00 mm	2,517	2000152
40 AST 160-20	160	2.00 mm	3,122	2000153
40 AST 200-20	200	2.00 mm	3,476	2000154
40 AST 300-20	300	2.00 mm	4,675	2000115
40 AST 400-20	400	2.00 mm	5,870	2000117
40 AST 500-20	500	2.00 mm	7,076	2000119
40 AST 600-20	600	2.00 mm	8,271	2000121
40 AST 700-20	700	2.00 mm	9,928	2000454
40 AST 800-20	800	2.00 mm	11,211	2000455
40 AST 900-20	900	2.00 mm	12,493	2000456

H = YÜKSEKLİK = HEIGHT / W = GENİŞLİK = WIDTH / T = KALINLIK = THICKNESS

40 AST 100-10

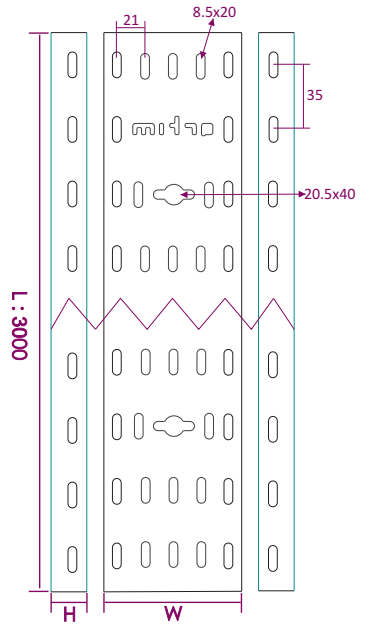
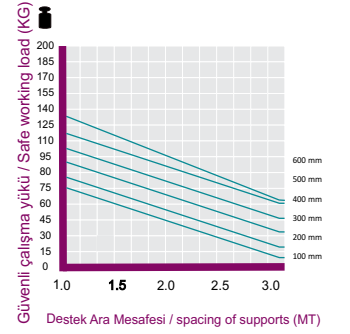

Standart uzunluk L:3000 mm
Toplu miktarlarda Özel ölçüler yapılabilir.
Standard Length L:3000 mm
Custom sizes can be made in bulk quantities.

ARTIM METAL ELEKTRİK A.Ş.

* Farklı kalınlık ve ölçülerde üretim yapılabılır.
* Malzeme ağırlıkları yaklaşık değerlerdir, \pm %10 değişiklik gösterebilir.
* Malzeme kalınlık toleransı \pm %10 dur.
* Lütfen siparişlerinizde sipariş kodu veya ürün kodu ve Kaplama şeklini belirtiniz.

* We can produce cable trays different thickness and dimensions
* Cable trays are shown approximately weight, they could change \pm %10 difference.
* Cable trays thickness tolerances are shown \pm %10 .
* Please indicate order code and coating type in your orders.

H40 AST SERIES

STANDART TIP KABLO KANALI (DELİKSİZ)

MEDIUM DUTY CABLE TRAYS (NON PERFORATED)

PREGALVANİZ (PG)
PREGALVANİZ (PG)
TS EN 10346

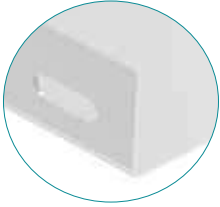

0.80 mm

Sipariş Kodu Order Code	W (mm)	T (mm)	Ağırlık (kg/m) Weight (kg/m)	Barkod Kodu Barcode Code
40 AST 050-08D	50	0.80 mm	0,756	2000101
40 AST 100-08D	100	0.80 mm	1,047	2000142
40 AST 120-08D	120	0.80 mm	1,158	2000143
40 AST 160-08D	160	0.80 mm	1,654	2000144
40 AST 200-09D	200	0.90 mm	1,801	2000145

1.00 mm

Sipariş Kodu Order Code	W (mm)	T (mm)	Ağırlık (kg/m) Weight (kg/m)	Barkod Kodu Barcode Code
40 AST 050-10D	50	1.00 mm	0,944	2000146
40 AST 100-10D	100	1.00 mm	1,308	2000104
40 AST 120-10D	120	1.00 mm	1,448	2000107
40 AST 160-10D	160	1.00 mm	1,795	2000108
40 AST 200-10D	200	1.00 mm	2,001	2000110

1.20 mm

Sipariş Kodu Order Code	W (mm)	T (mm)	Ağırlık (kg/m) Weight (kg/m)	Barkod Kodu Barcode Code
40 AST 050-12D	50	1.20 mm	1,275	2000102
40 AST 100-12D	100	1.20 mm	1,566	2000105
40 AST 120-12D	120	1.20 mm	1,738	2000147
40 AST 160-12D	160	1.20 mm	2,154	2000109
40 AST 200-12D	200	1.20 mm	2,390	2000111
40 AST 300-12D	300	1.20 mm	2,803	2000113

1.50 mm

Sipariş Kodu Order Code	W (mm)	T (mm)	Ağırlık (kg/m) Weight (kg/m)	Barkod Kodu Barcode Code
40 AST 050-15D	50	1.50 mm	1,415	2000103
40 AST 100-15D	100	1.50 mm	1,961	2000106
40 AST 120-15D	120	1.50 mm	2,171	2000148
40 AST 160-15D	160	1.50 mm	2,693	2000149
40 AST 200-15D	200	1.50 mm	2,998	2000112
40 AST 300-15D	300	1.50 mm	4,034	2000114
40 AST 400-15D	400	1.50 mm	5,066	2000116
40 AST 500-15D	500	1.50 mm	6,103	2000118
40 AST 600-15D	600	1.50 mm	7,133	2000120

2.00 mm

Sipariş Kodu Order Code	W (mm)	T (mm)	Ağırlık (kg/m) Weight (kg/m)	Barkod Kodu Barcode Code
40 AST 050-20D	50	2.00 mm	1,886	2000150
40 AST 100-20D	100	2.00 mm	2,614	2000151
40 AST 120-20D	120	2.00 mm	2,895	2000152
40 AST 160-20D	160	2.00 mm	3,590	2000153
40 AST 200-20D	200	2.00 mm	3,997	2000154
40 AST 300-20D	300	2.00 mm	5,376	2000115
40 AST 400-20D	400	2.00 mm	6,751	2000117
40 AST 500-20D	500	2.00 mm	8,137	2000119
40 AST 600-20D	600	2.00 mm	9,512	2000121
40 AST 700-20D	700	2.00 mm	11,544	2000454
40 AST 800-20D	800	2.00 mm	13,036	2000455
40 AST 900-20D	900	2.00 mm	14,527	2000456

H = YÜKSEKLİK = HEIGHT / W = GENİŞLİK = WIDTH / T = KALINLIK = THICKNESS

40 AST 100-10D

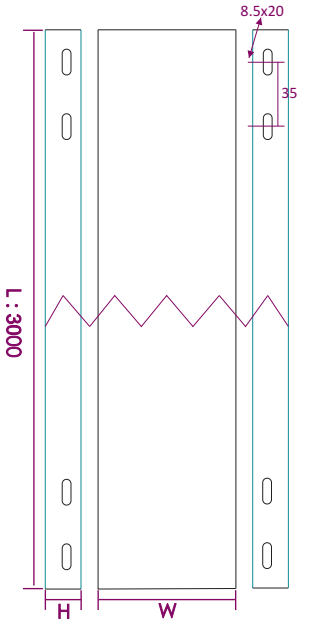
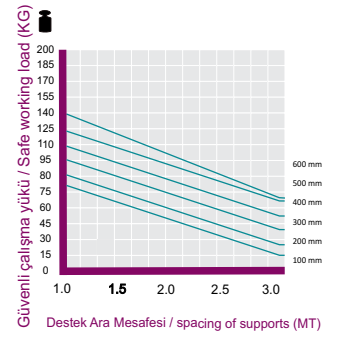

Standart uzunluk L:3000 mm
Toplu miktarlarda Özel ölçüler yapılabilir.
Standard Length L:3000 mm
Custom sizes can be made in bulk quantities.

ARTIM METAL ELEKTRİK A.Ş.

* Farklı kalınlık ve ölçülerde üretim yapılabılır.
* Malzeme ağırlıkları yaklaşık değerlerdir, ± %10 değişiklik gösterebilir.
* Malzeme kalınlık toleransı ± %10 dur.
* Lütfen siparişlerinizde sipariş kodu veya ürün kodu ve Kaplama şeklini belirtiniz.

* We can produce cable trays different thickness and dimensions
* Cable trays are shown approximately weight, they could change ± %10 difference.
* Cable trays thickness tolerances are shown ± %10 .
* Please indicate order code and coating type in your orders.

H40 AST SERIES

STANDART TIP KABLO KANALI (DELİKSİZ)

MEDIUM DUTY CABLE TRAYS (NON PERFORATED)

SICAK DALDIRMA (SD)
HOT DIP GALVANIZED (HDG)
TS EN ISO 1461

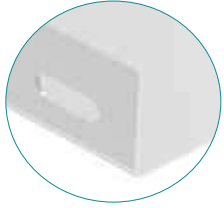

0.80 mm

Sipariş Kodu Order Code	W (mm)	T (mm)	Ağırlık (kg/m) Weight (kg/m)	Barkod Kodu Barcode Code
40 AST 050-08D	50	0.80 mm	0,992	2000101
40 AST 100-08D	100	0.80 mm	1,153	2000142
40 AST 120-08D	120	0.80 mm	1,275	2000143
40 AST 160-08D	160	0.80 mm	1,822	2000144
40 AST 200-09D	200	0.90 mm	1,983	2000145

1.00 mm

Sipariş Kodu Order Code	W (mm)	T (mm)	Ağırlık (kg/m) Weight (kg/m)	Barkod Kodu Barcode Code
40 AST 050-10D	50	1.00 mm	1,240	2000146
40 AST 100-10D	100	1.00 mm	1,442	2000104
40 AST 120-10D	120	1.00 mm	1,595	2000107
40 AST 160-10D	160	1.00 mm	2,277	2000108
40 AST 200-10D	200	1.00 mm	2,203	2000110

1.20 mm

Sipariş Kodu Order Code	W (mm)	T (mm)	Ağırlık (kg/m) Weight (kg/m)	Barkod Kodu Barcode Code
40 AST 050-12D	50	1.20 mm	1,390	2000102
40 AST 100-12D	100	1.20 mm	1,724	2000105
40 AST 120-12D	120	1.20 mm	1,914	2000147
40 AST 160-12D	160	1.20 mm	2,666	2000109
40 AST 200-12D	200	1.20 mm	2,631	2000111
40 AST 300-12D	300	1.20 mm	3,087	2000113

1.50 mm

Sipariş Kodu Order Code	W (mm)	T (mm)	Ağırlık (kg/m) Weight (kg/m)	Barkod Kodu Barcode Code
40 AST 050-15D	50	1.50 mm	1,860	2000103
40 AST 100-15D	100	1.50 mm	2,159	2000106
40 AST 120-15D	120	1.50 mm	2,232	2000148
40 AST 160-15D	160	1.50 mm	3,110	2000149
40 AST 200-15D	200	1.50 mm	3,302	2000112
40 AST 300-15D	300	1.50 mm	4,440	2000114
40 AST 400-15D	400	1.50 mm	5,573	2000116
40 AST 500-15D	500	1.50 mm	6,717	2000118
40 AST 600-15D	600	1.50 mm	7,850	2000120

2.00 mm

Sipariş Kodu Order Code	W (mm)	T (mm)	Ağırlık (kg/m) Weight (kg/m)	Barkod Kodu Barcode Code
40 AST 050-20D	50	2.00 mm	2,231	2000150
40 AST 100-20D	100	2.00 mm	2,929	2000151
40 AST 120-20D	120	2.00 mm	3,029	2000152
40 AST 160-20D	160	2.00 mm	4,219	2000153
40 AST 200-20D	200	2.00 mm	4,480	2000154
40 AST 300-20D	300	2.00 mm	5,917	2000115
40 AST 400-20D	400	2.00 mm	7,427	2000117
40 AST 500-20D	500	2.00 mm	8,954	2000119
40 AST 600-20D	600	2.00 mm	10,464	2000121
40 AST 700-20D	700	2.00 mm	12,698	2000454
40 AST 800-20D	800	2.00 mm	14,340	2000455
40 AST 900-20D	900	2.00 mm	15,980	2000456

H = YÜKSEKLİK = HEIGHT / W = GENİŞLİK = WIDTH / T = KALINLIK = THICKNESS

40 AST 100-10D

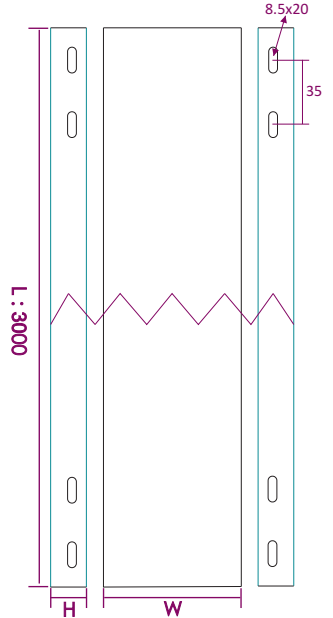
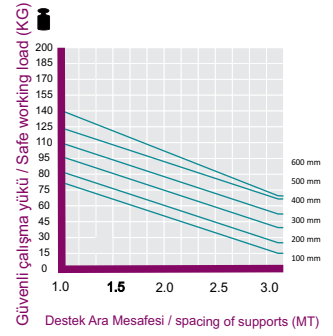

Standart uzunluk L:3000 mm
Toplu miktarlarda Özel ölçüler yapılabilir.
Standard Length L:3000 mm
Custom sizes can be made in bulk quantities.

* Farklı kalınlık ve ölçülerde üretim yapılabılır.
* Malzeme ağırlıkları yaklaşık değerlerdir, \pm %10 değişiklik gösterebilir.
* Malzeme kalınlık toleransı \pm %10 dur.
* Lütfen siparişlerinizde sipariş kodu veya ürün kodu ve Kaplama şeklini belirtiniz.

* We can produce cable trays different thickness and dimensions
* Cable trays are shown approximately weight, they could change \pm %10 difference.
* Cable trays thickness tolerances are shown \pm %10 .
* Please indicate order code and coating type in your orders.

H50 AGH SERIES

AGIR HIZMET TIP KABLO KANALI

HEAVY DUTY TYPE CABLE TRAYS

PREGALVANIZ (PG)
PREGALVANIZED (PG)
TS EN 10346

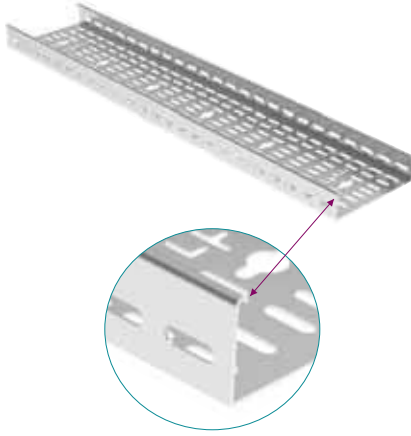

0.80 mm

Sipariş Kodu Order Code	W (mm)	T (mm)	Ağırlık (kg/m) Weight (kg/m)	Barkod Kodu Barcode Code
50 AGH 050-08	50	0.80 mm	0,902	2000323
50 AGH 100-08	100	0.80 mm	1,148	2000395
50 AGH 160-08	160	0.80 mm	1,321	2000397
50 AGH 200-09	200	0.90 mm	1,826	2000398

1.00 mm

Sipariş Kodu Order Code	W (mm)	T (mm)	Ağırlık (kg/m) Weight (kg/m)	Barkod Kodu Barcode Code
50 AGH 050-10	50	1.00 mm	1,127	2000399
50 AGH 100-10	100	1.00 mm	1,436	2000326
50 AGH 160-10	160	1.00 mm	1,651	2000329
50 AGH 200-10	200	1.00 mm	2,029	2000332
50 AGH 300-10	300	1.00 mm	2,626	2000335

1.20 mm

Sipariş Kodu Order Code	W (mm)	T (mm)	Ağırlık (kg/m) Weight (kg/m)	Barkod Kodu Barcode Code
50 AGH 050-12	50	1.20 mm	1,348	2000324
50 AGH 100-12	100	1.20 mm	1,725	2000327
50 AGH 160-12	160	1.20 mm	2,166	2000330
50 AGH 200-12	200	1.20 mm	2,440	2000333
50 AGH 300-12	300	1.20 mm	3,151	2000336
50 AGH 400-12	400	1.20 mm	3,866	2000339
50 AGH 500-12	500	1.20 mm	4,586	2000342

1.50 mm

Sipariş Kodu Order Code	W (mm)	T (mm)	Ağırlık (kg/m) Weight (kg/m)	Barkod Kodu Barcode Code
50 AGH 050-15	50	1.50 mm	1,686	2000325
50 AGH 100-15	100	1.50 mm	2,156	2000328
50 AGH 160-15	160	1.50 mm	2,685	2000331
50 AGH 200-15	200	1.50 mm	3,048	2000334
50 AGH 300-15	300	1.50 mm	3,940	2000337
50 AGH 400-15	400	1.50 mm	4,831	2000340
50 AGH 500-15	500	1.50 mm	5,728	2000343
50 AGH 600-15	600	1.50 mm	6,620	2000345

2.00 mm

Sipariş Kodu Order Code	W (mm)	T (mm)	Ağırlık (kg/m) Weight (kg/m)	Barkod Kodu Barcode Code
50 AGH 050-20	50	2.00 mm	1,806	2000403
50 AGH 100-20	100	2.00 mm	2,926	2000404
50 AGH 160-20	160	2.00 mm	3,643	2000406
50 AGH 200-20	200	2.00 mm	4,136	2000407
50 AGH 300-20	300	2.00 mm	5,253	2000338
50 AGH 400-20	400	2.00 mm	6,444	2000341
50 AGH 500-20	500	2.00 mm	7,634	2000344
50 AGH 600-20	600	2.00 mm	8,820	2000346
50 AGH 700-20	700	2.00 mm	10,441	2000457
50 AGH 800-20	800	2.00 mm	11,723	2000458
50 AGH 900-20	900	2.00 mm	13,006	2000459

H = YÜKSEKLİK = HEIGHT / W = GENİŞLİK = WIDTH / T = KALINLIK = THICKNESS

50 AGH 100 - 10

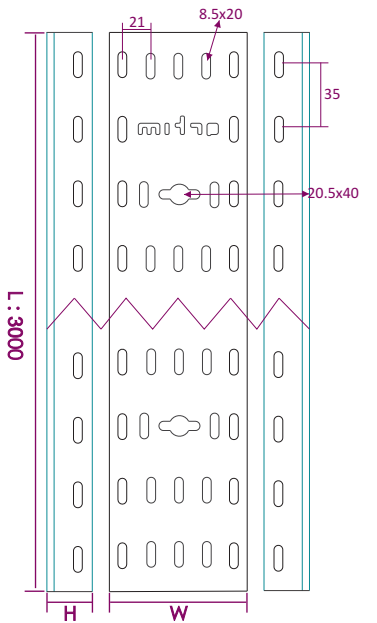
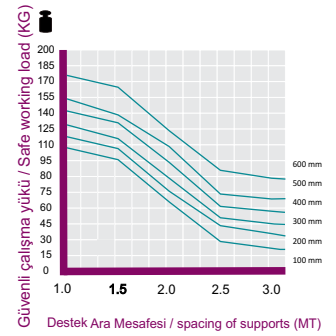
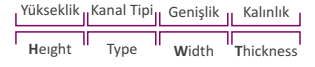

Standart uzunluk L:3000 mm
Toplu miktarlarda Özel ölçüler yapılabilir.
Standard Length L:3000 mm
Custom sizes can be made in bulk quantities.

ARTIM METAL ELEKTRİK A.Ş.

* Farklı kalınlık ve ölçülerde üretim yapılabılır.
* Malzeme ağırlıkları yaklaşık değerlerdir, ± %10 değişiklik gösterebilir.
* Malzeme kalınlık toleransı ± %10 dur.
* Lütfen siparişlerinizde sipariş kodu veya ürün kodu ve Kaplama şeklini belirtiniz.

* We can produce cable trays different thickness and dimensions
* Cable trays are shown approximately weight, they could change ± %10 difference.
* Cable trays thickness tolerances are shown ± %10 .
* Please indicate order code and coating type in your orders.

H50 AGH SERIES

AGIR HIZMET TIP KABLO KANALI

HEAVY DUTY TYPE CABLE TRAYS

SICAK DALDIRMA (SD)
HOT DIP GALVANIZED (SD)
TS EN ISO 1461

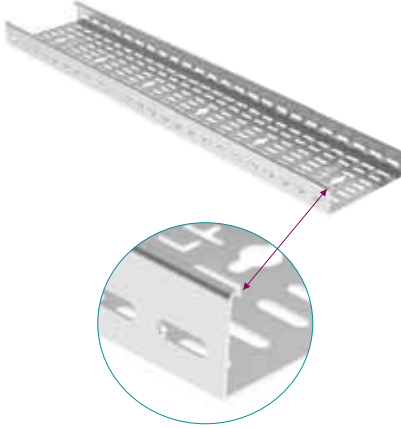

0.80 mm

Sipariş Kodu Order Code	W (mm)	T (mm)	Ağırlık (kg/m) Weight (kg/m)	Barkod Kodu Barcode Code
50 AGH 050-08	50	0.80 mm	0,990	2000323
50 AGH 100-08	100	0.80 mm	1,266	2000395
50 AGH 160-08	160	0.80 mm	1,454	2000397
50 AGH 200-09	200	0.90 mm	1,787	2000398

1.00 mm

Sipariş Kodu Order Code	W (mm)	T (mm)	Ağırlık (kg/m) Weight (kg/m)	Barkod Kodu Barcode Code
50 AGH 050-10	50	1.00 mm	1,237	2000399
50 AGH 100-10	100	1.00 mm	1,583	2000326
50 AGH 160-10	160	1.00 mm	1,818	2000329
50 AGH 200-10	200	1.00 mm	2,234	2000332
50 AGH 300-10	300	1.00 mm	2,891	2000335

1.20 mm

Sipariş Kodu Order Code	W (mm)	T (mm)	Ağırlık (kg/m) Weight (kg/m)	Barkod Kodu Barcode Code
50 AGH 050-12	50	1.20 mm	1,485	2000324
50 AGH 100-12	100	1.20 mm	1,901	2000327
50 AGH 160-12	160	1.20 mm	2,367	2000330
50 AGH 200-12	200	1.20 mm	2,685	2000333
50 AGH 300-12	300	1.20 mm	3,469	2000336
50 AGH 400-12	400	1.20 mm	4,253	2000339
50 AGH 500-12	500	1.20 mm	5,047	2000342

1.50 mm

Sipariş Kodu Order Code	W (mm)	T (mm)	Ağırlık (kg/m) Weight (kg/m)	Barkod Kodu Barcode Code
50 AGH 050-15	50	1.50 mm	1,857	2000325
50 AGH 100-15	100	1.50 mm	2,372	2000328
50 AGH 160-15	160	1.50 mm	3,007	2000331
50 AGH 200-15	200	1.50 mm	3,357	2000334
50 AGH 300-15	300	1.50 mm	4,337	2000337
50 AGH 400-15	400	1.50 mm	5,316	2000340
50 AGH 500-15	500	1.50 mm	6,301	2000343
50 AGH 600-15	600	1.50 mm	7,281	2000345

2.00 mm

Sipariş Kodu Order Code	W (mm)	T (mm)	Ağırlık (kg/m) Weight (kg/m)	Barkod Kodu Barcode Code
50 AGH 050-20	50	2.00 mm	2,520	2000403
50 AGH 100-20	100	2.00 mm	3,219	2000404
50 AGH 160-20	160	2.00 mm	4,080	2000406
50 AGH 200-20	200	2.00 mm	4,555	2000407
50 AGH 300-20	300	2.00 mm	5,782	2000338
50 AGH 400-20	400	2.00 mm	7,088	2000341
50 AGH 500-20	500	2.00 mm	8,399	2000344
50 AGH 600-20	600	2.00 mm	9,702	2000346
50 AGH 700-20	700	2.00 mm	11,485	2000457
50 AGH 800-20	800	2.00 mm	12,895	2000458
50 AGH 900-20	900	2.00 mm	14,307	2000459

H = YÜKSEKLİK = HEIGHT / W = GENİŞLİK = WIDTH / T = KALINLIK = THICKNESS

50 AGH 100 - 10

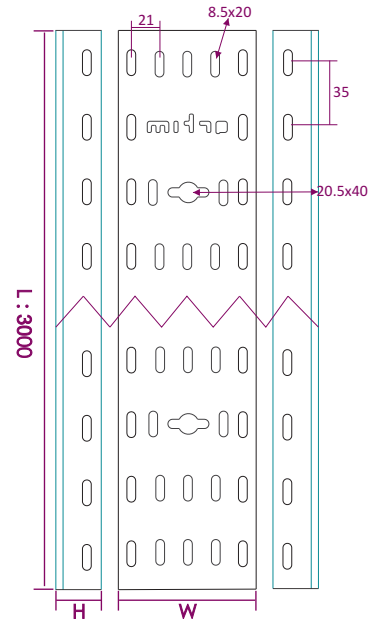
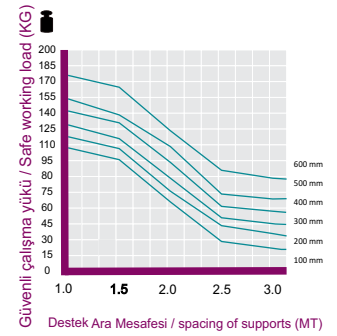

Standart uzunluk L:3000 mm
Toplu miktarlarda Özel ölçüler yapılabilir.
Standard Length L:3000 mm
Custom sizes can be made in bulk quantities.

* Farklı kalınlık ve ölçülerde üretim yapılabılır.
* Malzeme ağırlıkları yaklaşık değerlerdir, \pm %10 değişiklik gösterebilir.
* Malzeme kalınlık toleransı \pm %10 dur.
* Lütfen siparişlerinizde sipariş kodu veya ürün kodu ve Kaplama şeklini belirtiniz.

* We can produce cable trays different thickness and dimensions
* Cable trays are shown approximately weight, they could change \pm %10 difference.
* Cable trays thickness tolerances are shown \pm %10 .
* Please indicate order code and coating type in your orders.

H50 AGH SERIES

AGIR HIZMET KABLO KANALI (DELIKSİZ)

HEAVY DUTY TYPE CABLE TRAYS (NON PERFORATED)

PREGALVANIZ (PG)
PREGALVANIZED (PG)
TS EN 10346

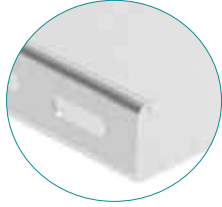

0.80 mm

Sipariş Kodu Order Code	W (mm)	T (mm)	Ağırlık (kg/m) Weight (kg/m)	Barkod Kodu Barcode Code
50 AGH 050-08D	50	0.80 mm	1,037	2000323
50 AGH 100-08D	100	0.80 mm	1,320	2000395
50 AGH 160-08D	160	0.80 mm	1,519	2000397
50 AGH 200-09D	200	0.90 mm	2,100	2000398

1.00 mm

Sipariş Kodu Order Code	W (mm)	T (mm)	Ağırlık (kg/m) Weight (kg/m)	Barkod Kodu Barcode Code
50 AGH 050-10D	50	1.00 mm	1,296	2000399
50 AGH 100-10D	100	1.00 mm	1,651	2000326
50 AGH 160-10D	160	1.00 mm	1,899	2000329
50 AGH 200-10D	200	1.00 mm	2,333	2000332
50 AGH 300-10D	300	1.00 mm	3,020	2000335

1.20 mm

Sipariş Kodu Order Code	W (mm)	T (mm)	Ağırlık (kg/m) Weight (kg/m)	Barkod Kodu Barcode Code
50 AGH 050-12D	50	1.20 mm	1,550	2000324
50 AGH 100-12D	100	1.20 mm	1,984	2000327
50 AGH 160-12D	160	1.20 mm	2,491	2000330
50 AGH 200-12D	200	1.20 mm	2,806	2000333
50 AGH 300-12D	300	1.20 mm	3,624	2000336
50 AGH 400-12D	400	1.20 mm	4,446	2000339
50 AGH 500-12D	500	1.20 mm	5,274	2000342

1.50 mm

Sipariş Kodu Order Code	W (mm)	T (mm)	Ağırlık (kg/m) Weight (kg/m)	Barkod Kodu Barcode Code
50 AGH 050-15D	50	1.50 mm	1,939	2000325
50 AGH 100-15D	100	1.50 mm	2,479	2000328
50 AGH 160-15D	160	1.50 mm	3,088	2000331
50 AGH 200-15D	200	1.50 mm	3,505	2000334
50 AGH 300-15D	300	1.50 mm	4,531	2000337
50 AGH 400-15D	400	1.50 mm	5,556	2000340
50 AGH 500-15D	500	1.50 mm	6,587	2000343
50 AGH 600-15D	600	1.50 mm	7,613	2000345

2.00 mm

Sipariş Kodu Order Code	W (mm)	T (mm)	Ağırlık (kg/m) Weight (kg/m)	Barkod Kodu Barcode Code
50 AGH 050-20D	50	2.00 mm	2,077	2000403
50 AGH 100-20D	100	2.00 mm	3,365	2000404
50 AGH 160-20D	160	2.00 mm	4,189	2000406
50 AGH 200-20D	200	2.00 mm	4,756	2000407
50 AGH 300-20D	300	2.00 mm	6,041	2000338
50 AGH 400-20D	400	2.00 mm	7,411	2000341
50 AGH 500-20D	500	2.00 mm	8,779	2000344
50 AGH 600-20D	600	2.00 mm	10,143	2000346
50 AGH 700-20D	700	2.00 mm	12,141	2000457
50 AGH 800-20D	800	2.00 mm	13,632	2000458
50 AGH 900-20D	900	2.00 mm	15,124	2000459

H = YÜKSEKLİK = HEIGHT / W = GENİŞLİK = WIDTH / T = KALINLIK = THICKNESS

50 AGH 100 10D

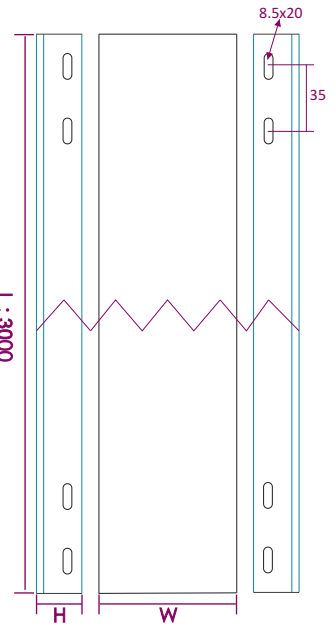
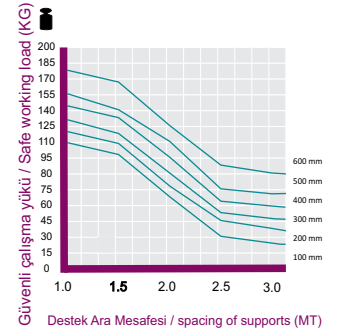

Standart uzunluk L:3000 mm
Toplu miktarlarda Özel ölçüler yapılabilir.
Standard Length L:3000 mm
Custom sizes can be made in bulk quantities.

ARTIM METAL ELEKTRİK A.Ş.

* Farklı kalınlık ve ölçülerde üretim yapılabılır.
* Malzeme ağırlıkları yaklaşık değerlerdir, ± %10 değişiklik gösterebilir.
* Malzeme kalınlık toleransı ± %10 dur.
* Lütfen siparişlerinizde sipariş kodu veya ürün kodu ve Kaplama şeklini belirtiniz.

* We can produce cable trays different thickness and dimensions
* Cable trays are shown approximately weight, they could change ± %10 difference.
* Cable trays thickness tolerances are shown ± %10 .
* Please indicate order code and coating type in your orders.

H50 AGH SERIES

AGIR HIZMET KABLO KANALI (DELIKSİZ)

HEAVY DUTY TYPE CABLE TRAYS (NON PERFORATED)

SICAK DALDIRMA (SD)
HOT DIP GALVANIZED (SD)
TS EN ISO 1461

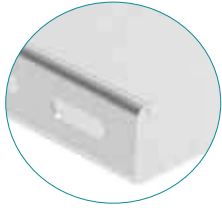

0.80 mm

Sipariş Kodu Order Code	W (mm)	T (mm)	Ağırlık (kg/m) Weight (kg/m)	Barkod Kodu Barcode Code
50 AGH 050-08D	50	0.80 mm	1,139	2000323
50 AGH 100-08D	100	0.80 mm	1,456	2000395
50 AGH 160-08D	160	0.80 mm	1,672	2000397
50 AGH 200-09D	200	0.90 mm	2,055	2000398

1.00 mm

Sipariş Kodu Order Code	W (mm)	T (mm)	Ağırlık (kg/m) Weight (kg/m)	Barkod Kodu Barcode Code
50 AGH 050-10D	50	1.00 mm	1,423	2000399
50 AGH 100-10D	100	1.00 mm	1,820	2000326
50 AGH 160-10D	160	1.00 mm	2,091	2000329
50 AGH 200-10D	200	1.00 mm	2,569	2000332
50 AGH 300-10D	300	1.00 mm	3,325	2000335

1.20 mm

Sipariş Kodu Order Code	W (mm)	T (mm)	Ağırlık (kg/m) Weight (kg/m)	Barkod Kodu Barcode Code
50 AGH 050-12D	50	1.20 mm	1,708	2000324
50 AGH 100-12D	100	1.20 mm	2,186	2000327
50 AGH 160-12D	160	1.20 mm	2,722	2000330
50 AGH 200-12D	200	1.20 mm	3,088	2000333
50 AGH 300-12D	300	1.20 mm	3,989	2000336
50 AGH 400-12D	400	1.20 mm	4,891	2000339
50 AGH 500-12D	500	1.20 mm	5,804	2000342

1.50 mm

Sipariş Kodu Order Code	W (mm)	T (mm)	Ağırlık (kg/m) Weight (kg/m)	Barkod Kodu Barcode Code
50 AGH 050-15D	50	1.50 mm	2,136	2000325
50 AGH 100-15D	100	1.50 mm	2,728	2000328
50 AGH 160-15D	160	1.50 mm	3,458	2000331
50 AGH 200-15D	200	1.50 mm	3,861	2000334
50 AGH 300-15D	300	1.50 mm	4,988	2000337
50 AGH 400-15D	400	1.50 mm	6,113	2000340
50 AGH 500-15D	500	1.50 mm	7,246	2000343
50 AGH 600-15D	600	1.50 mm	8,373	2000345

2.00 mm

Sipariş Kodu Order Code	W (mm)	T (mm)	Ağırlık (kg/m) Weight (kg/m)	Barkod Kodu Barcode Code
50 AGH 050-20D	50	2.00 mm	2,898	2000403
50 AGH 100-20D	100	2.00 mm	3,702	2000404
50 AGH 160-20D	160	2.00 mm	4,692	2000406
50 AGH 200-20D	200	2.00 mm	5,238	2000407
50 AGH 300-20D	300	2.00 mm	6,649	2000338
50 AGH 400-20D	400	2.00 mm	8,151	2000341
50 AGH 500-20D	500	2.00 mm	9,659	2000344
50 AGH 600-20D	600	2.00 mm	11,157	2000346
50 AGH 700-20D	700	2.00 mm	13,355	2000457
50 AGH 800-20D	800	2.00 mm	14,995	2000458
50 AGH 900-20D	900	2.00 mm	16,636	2000459

H = YÜKSEKLİK = HEIGHT / W = GENİŞLİK = WIDTH / T = KALINLIK = THICKNESS

50 AGH 100 10D

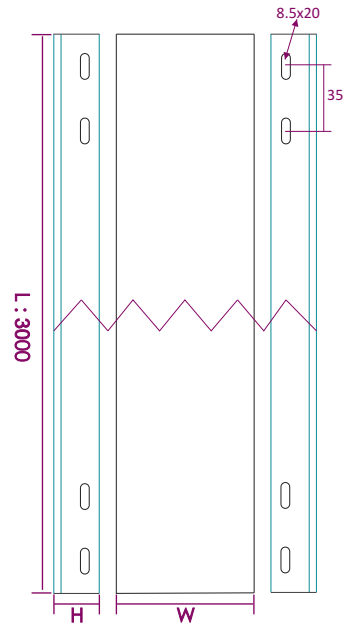
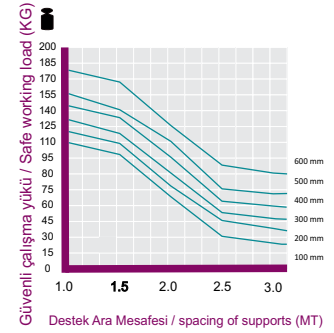

Standart uzunluk L:3000 mm
Toplu miktarlarda Özel ölçüler yapılabilir.
Standard Length L:3000 mm
Custom sizes can be made in bulk quantities.

* Farklı kalınlık ve ölçülerde üretim yapılabılır.
* Malzeme ağırlıkları yaklaşık değerlerdir, ± %10 değişiklik gösterebilir.
* Malzeme kalınlık toleransı ± %10 dur.
* Lütfen siparişlerinizde sipariş kodu veya ürün kodu ve Kaplama şeklini belirtiniz.

* We can produce cable trays different thickness and dimensions
* Cable trays are shown approximately weight, they could change ± %10 difference.
* Cable trays thickness tolerances are shown ± %10 .
* Please indicate order code and coating type in your orders.

H50 AST SERIES

STANDART TIP KABLO KANALLARI

MEDIUM DUTY CABLE TRAYS

PREGALVANIZ (PG)
PREGALVANIZED (PG)
TS EN 10346

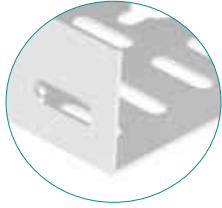

0.80 mm

Sipariş Kodu Order Code	W (mm)	T (mm)	Ağırlık (kg/m) Weight (kg/m)	Barkod Kodu Barcode Code
50 AST 050-08	50	0.80 mm	0,779	2000122
50 AST 100-08	100	0.80 mm	1,035	2000155
50 AST 160-08	160	0.80 mm	1,403	2000157
50 AST 200-09	200	0.90 mm	1,701	2000158

1.00 mm

Sipariş Kodu Order Code	W (mm)	T (mm)	Ağırlık (kg/m) Weight (kg/m)	Barkod Kodu Barcode Code
50 AST 050-10	50	1.00 mm	0,975	2000159
50 AST 100-10	100	1.00 mm	1,294	2000124
50 AST 160-10	160	1.00 mm	1,754	2000128
50 AST 200-10	200	1.00 mm	1,891	2000130

1.20 mm

Sipariş Kodu Order Code	W (mm)	T (mm)	Ağırlık (kg/m) Weight (kg/m)	Barkod Kodu Barcode Code
50 AST 050-12	50	1.20 mm	1,171	2000123
50 AST 100-12	100	1.20 mm	1,548	2000126
50 AST 160-12	160	1.20 mm	2,105	2000129
50 AST 200-12	200	1.20 mm	2,269	2000131
50 AST 300-12	300	1.20 mm	2,989	2000133

1.50 mm

Sipariş Kodu Order Code	W (mm)	T (mm)	Ağırlık (kg/m) Weight (kg/m)	Barkod Kodu Barcode Code
50 AST 050-15	50	1.50 mm	1,460	2000124
50 AST 100-15	100	1.50 mm	1,936	2000127
50 AST 160-15	160	1.50 mm	2,456	2000163
50 AST 200-15	200	1.50 mm	2,837	2000132
50 AST 300-15	300	1.50 mm	3,739	2000134
50 AST 400-15	400	1.50 mm	4,635	2000136
50 AST 500-15	500	1.50 mm	5,537	2000138
50 AST 600-15	600	1.50 mm	6,434	2000140
50 AST 600-15	600	1.50 mm	6,434	2000140

2.00 mm

Sipariş Kodu Order Code	W (mm)	T (mm)	Ağırlık (kg/m) Weight (kg/m)	Barkod Kodu Barcode Code
50 AST 050-20	50	2.00 mm	1,981	2000164
50 AST 100-20	100	2.00 mm	2,627	2000165
50 AST 160-20	160	2.00 mm	3,333	2000166
50 AST 200-20	200	2.00 mm	3,850	2000167
50 AST 300-20	300	2.00 mm	4,983	2000135
50 AST 400-20	400	2.00 mm	6,184	2000137
50 AST 500-20	500	2.00 mm	7,384	2000139
50 AST 600-20	600	2.00 mm	8,580	2000141
50 AST 700-20	700	2.00 mm	10,066	2000460
50 AST 800-20	800	2.00 mm	11,334	2000461
50 AST 900-20	900	2.00 mm	12,601	2000462

H = YÜKSEKLİK = HEIGHT / W = GENİŞLİK = WIDTH / T = KALINLIK = THICKNESS

50 AST 100-10

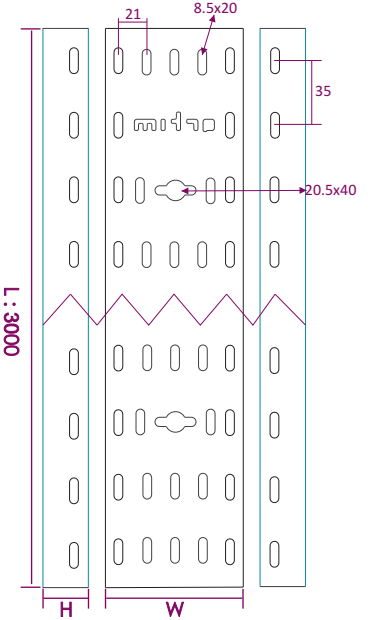
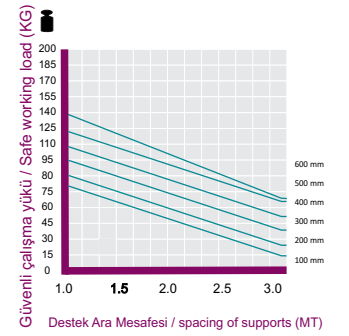

Standart uzunluk L:3000 mm
Toplu miktarlarda Özel ölçüler yapılabilir.
Standard Length L:3000 mm
Custom sizes can be made in bulk quantities.

ARTIM METAL ELEKTRİK A.Ş.

* Farklı kalınlık ve ölçülerde üretim yapılabılır.
* Malzeme ağırlıkları yaklaşık değerlerdir, \pm %10 değişiklik gösterebilir.
* Malzeme kalınlık toleransı \pm %10 dur.
* Lütfen siparişlerinizde sipariş kodu veya ürün kodu ve Kaplama şeklini belirtiniz.

* We can produce cable trays different thickness and dimensions
* Cable trays are shown approximately weight, they could change \pm %10 difference.
* Cable trays thickness tolerances are shown \pm %10 .
* Please indicate order code and coating type in your orders.

H50 AST SERIES

STANDART TIP KABLO KANALLARI

MEDIUM DUTY CABLE TRAYS

SICAK DALDIRMA (SD)

HOT DIP GALVANIZED (SD)

TS EN ISO 1461

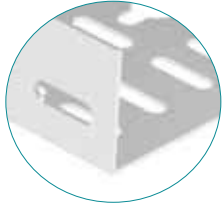

0.80 mm

Sipariş Kodu Order Code	W (mm)	T (mm)	Ağırlık (kg/m) Weight (kg/m)	Barkod Kodu Barcode Code
50 AST 050-08	50	0.80 mm	0,858	2000122
50 AST 100-08	100	0.80 mm	1,136	2000155
50 AST 160-08	160	0.80 mm	1,404	2000157
50 AST 200-09	200	0.90 mm	1,875	2000158

1.00 mm

Sipariş Kodu Order Code	W (mm)	T (mm)	Ağırlık (kg/m) Weight (kg/m)	Barkod Kodu Barcode Code
50 AST 050-10	50	1.00 mm	1,072	2000159
50 AST 100-10	100	1.00 mm	1,421	2000124
50 AST 160-10	160	1.00 mm	1,755	2000128
50 AST 200-10	200	1.00 mm	2,083	2000130

1.20 mm

Sipariş Kodu Order Code	W (mm)	T (mm)	Ağırlık (kg/m) Weight (kg/m)	Barkod Kodu Barcode Code
50 AST 050-12	50	1.20 mm	1,289	2000123
50 AST 100-12	100	1.20 mm	1,705	2000126
50 AST 160-12	160	1.20 mm	2,105	2000129
50 AST 200-12	200	1.20 mm	2,499	2000131
50 AST 300-12	300	1.20 mm	3,288	2000133

1.50 mm

Sipariş Kodu Order Code	W (mm)	T (mm)	Ağırlık (kg/m) Weight (kg/m)	Barkod Kodu Barcode Code
50 AST 050-15	50	1.50 mm	1,607	2000124
50 AST 100-15	100	1.50 mm	2,132	2000127
50 AST 160-15	160	1.50 mm	2,455	2000163
50 AST 200-15	200	1.50 mm	3,121	2000132
50 AST 300-15	300	1.50 mm	4,111	2000134
50 AST 400-15	400	1.50 mm	5,101	2000136
50 AST 500-15	500	1.50 mm	6,091	2000138
50 AST 600-15	600	1.50 mm	7,081	2000140
50 AST 600-15	600	1.50 mm	7,081	2000140

2.00 mm

Sipariş Kodu Order Code	W (mm)	T (mm)	Ağırlık (kg/m) Weight (kg/m)	Barkod Kodu Barcode Code
50 AST 050-20	50	2.00 mm	2,180	2000164
50 AST 100-20	100	2.00 mm	2,893	2000165
50 AST 160-20	160	2.00 mm	3,331	2000166
50 AST 200-20	200	2.00 mm	4,236	2000167
50 AST 300-20	300	2.00 mm	5,483	2000135
50 AST 400-20	400	2.00 mm	6,806	2000137
50 AST 500-20	500	2.00 mm	8,124	2000139
50 AST 600-20	600	2.00 mm	9,437	2000141
50 AST 700-20	700	2.00 mm	11,073	2000460
50 AST 800-20	800	2.00 mm	12,467	2000461
50 AST 900-20	900	2.00 mm	13,861	2000462

H = YÜKSEKLİK = HEIGHT / W = GENİŞLİK = WIDTH / T = KALINLIK = THICKNESS

50 AST 100-10

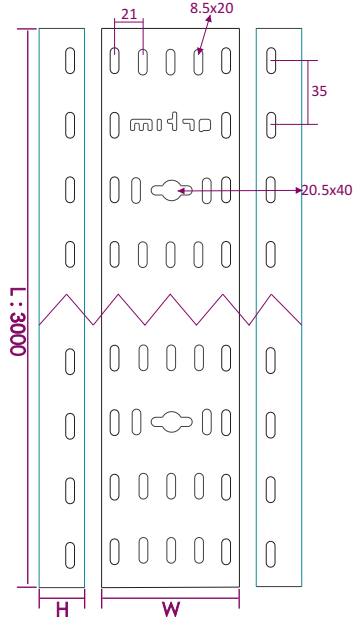
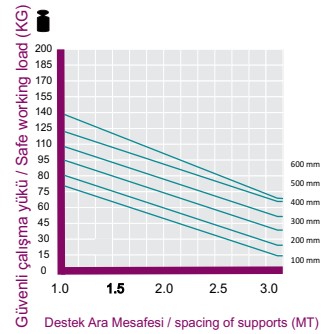

Standart uzunluk L:3000 mm
Toplu miktarlarda Özel ölçüler yapılabilir.
Standard Length L:3000 mm
Custom sizes can be made in bulk quantities.

* Farklı kalınlık ve ölçülerde üretim yapılabılır.
* Malzeme ağırlıkları yaklaşık değerlerdir, \pm %10 değişiklik gösterebilir.
* Malzeme kalınlık toleransı \pm %10 dur.
* Lütfen siparişlerinizde sipariş kodu veya ürün kodu ve Kaplama şeklini belirtiniz.

* We can produce cable trays different thickness and dimensions
* Cable trays are shown approximately weight, they could change \pm %10 difference.
* Cable trays thickness tolerances are shown \pm %10 .
* Please indicate order code and coating type in your orders.

H50 AST SERIES

STANDART TİP KABLO KANALLARI (DELİKSİZ)

MEDIUM DUTY CABLE TRAYS (NON PERFORATED)

PREGALVANİZ (PG)
PREGALVANIZED (PG)
TS EN 10346

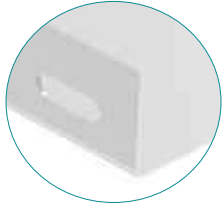

0.80 mm

Sipariş Kodu Order Code	W (mm)	T (mm)	Ağırlık (kg/m) Weight (kg/m)	Barkod Kodu Barcode Code
50 AST 050-08D	50	0.80 mm	0,896	2000122
50 AST 100-08D	100	0.80 mm	1,190	2000155
50 AST 160-08D	160	0.80 mm	1,613	2000157
50 AST 200-09D	200	0.90 mm	1,956	2000158

1.00 mm

Sipariş Kodu Order Code	W (mm)	T (mm)	Ağırlık (kg/m) Weight (kg/m)	Barkod Kodu Barcode Code
50 AST 050-10D	50	1.00 mm	1,121	2000159
50 AST 100-10D	100	1.00 mm	1,488	2000124
50 AST 160-10D	160	1.00 mm	2,017	2000128
50 AST 200-10D	200	1.00 mm	2,175	2000130

1.20 mm

Sipariş Kodu Order Code	W (mm)	T (mm)	Ağırlık (kg/m) Weight (kg/m)	Barkod Kodu Barcode Code
50 AST 050-12D	50	1.20 mm	1,347	2000123
50 AST 100-12D	100	1.20 mm	1,780	2000126
50 AST 160-12D	160	1.20 mm	2,421	2000129
50 AST 200-12D	200	1.20 mm	2,609	2000131
50 AST 300-12D	300	1.20 mm	3,437	2000133

1.50 mm

Sipariş Kodu Order Code	W (mm)	T (mm)	Ağırlık (kg/m) Weight (kg/m)	Barkod Kodu Barcode Code
50 AST 050-15D	50	1.50 mm	1,679	2000124
50 AST 100-15D	100	1.50 mm	2,226	2000127
50 AST 160-15D	160	1.50 mm	2,824	2000163
50 AST 200-15D	200	1.50 mm	3,263	2000132
50 AST 300-15D	300	1.50 mm	4,300	2000134
50 AST 400-15D	400	1.50 mm	5,330	2000136
50 AST 500-15D	500	1.50 mm	6,368	2000138
50 AST 600-15D	600	1.50 mm	7,399	2000140
50 AST 600-15D	600	1.50 mm	7,399	2000140

2.00 mm

Sipariş Kodu Order Code	W (mm)	T (mm)	Ağırlık (kg/m) Weight (kg/m)	Barkod Kodu Barcode Code
50 AST 050-20D	50	2.00 mm	2,278	2000164
50 AST 100-20D	100	2.00 mm	3,021	2000165
50 AST 160-20D	160	2.00 mm	3,833	2000166
50 AST 200-20D	200	2.00 mm	4,428	2000167
50 AST 300-20D	300	2.00 mm	5,730	2000135
50 AST 400-20D	400	2.00 mm	7,112	2000137
50 AST 500-20D	500	2.00 mm	8,492	2000139
50 AST 600-20D	600	2.00 mm	9,867	2000141
50 AST 700-20D	700	2.00 mm	11,842	2000460
50 AST 800-20D	800	2.00 mm	13,334	2000461
50 AST 900-20D	900	2.00 mm	14,825	2000462

H = YÜKSEKLİK = HEIGHT / W = GENİŞLİK = WIDTH / T = KALINLIK = THICKNESS

50 AST 100-10D

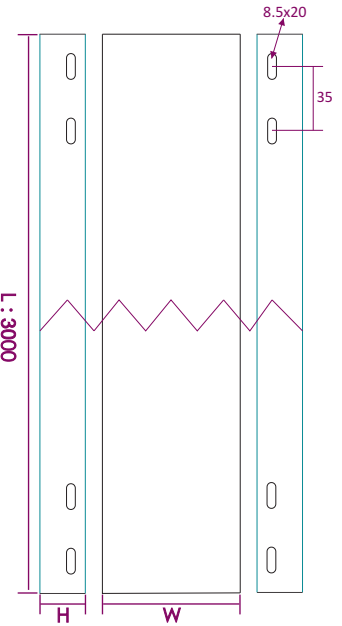
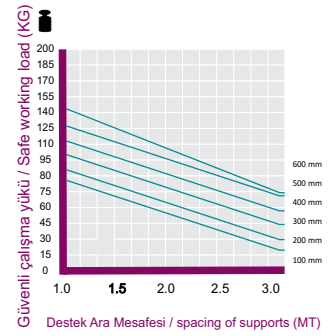

Standart uzunluk L:3000 mm
Toplu miktarlarda Özel ölçüler yapılabilir.
Standard Length L:3000 mm
Custom sizes can be made in bulk quantities.

ARTIM METAL ELEKTRİK A.Ş.

* Farklı kalınlık ve ölçülerde üretim yapılabılır.
* Malzeme ağırlıkları yaklaşık değerlerdir, ± %10 değişiklik gösterebilir.
* Malzeme kalınlık toleransı ± %10 dur.
* Lütfen siparişlerinizde sipariş kodu veya ürün kodu ve Kaplama şeklini belirtiniz.

* We can produce cable trays different thickness and dimensions
* Cable trays are shown approximately weight, they could change ± %10 difference.
* Cable trays thickness tolerances are shown ± %10 .
* Please indicate order code and coating type in your orders.

H50 AST SERIES

STANDART TIP KABLO KANALLARI (DELİKSİZ)

MEDIUM DUTY CABLE TRAYS (NON PERFORATED)

SICAK DALDIRMA (SD)

HOT DIP GALVANIZED (SD)

TS EN ISO 1461

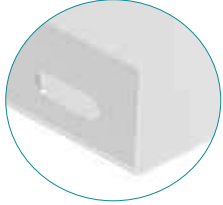

0.80 mm

Sipariş Kodu Order Code	W (mm)	T (mm)	Ağırlık (kg/m) Weight (kg/m)	Barkod Kodu Barcode Code
50 AST 050-08D	50	0.80 mm	0,987	2000122
50 AST 100-08D	100	0.80 mm	1,306	2000155
50 AST 160-08D	160	0.80 mm	1,615	2000157
50 AST 200-09D	200	0.90 mm	2,156	2000158

1.00 mm

Sipariş Kodu Order Code	W (mm)	T (mm)	Ağırlık (kg/m) Weight (kg/m)	Barkod Kodu Barcode Code
50 AST 050-10D	50	1.00 mm	1,233	2000159
50 AST 100-10D	100	1.00 mm	1,634	2000124
50 AST 160-10D	160	1.00 mm	2,018	2000128
50 AST 200-10D	200	1.00 mm	2,395	2000130

1.20 mm

Sipariş Kodu Order Code	W (mm)	T (mm)	Ağırlık (kg/m) Weight (kg/m)	Barkod Kodu Barcode Code
50 AST 050-12D	50	1.20 mm	1,482	2000123
50 AST 100-12D	100	1.20 mm	1,961	2000126
50 AST 160-12D	160	1.20 mm	2,421	2000129
50 AST 200-12D	200	1.20 mm	2,874	2000131
50 AST 300-12D	300	1.20 mm	3,781	2000133

1.50 mm

Sipariş Kodu Order Code	W (mm)	T (mm)	Ağırlık (kg/m) Weight (kg/m)	Barkod Kodu Barcode Code
50 AST 050-15D	50	1.50 mm	1,848	2000124
50 AST 100-15D	100	1.50 mm	2,452	2000127
50 AST 160-15D	160	1.50 mm	2,823	2000163
50 AST 200-15D	200	1.50 mm	3,589	2000132
50 AST 300-15D	300	1.50 mm	4,728	2000134
50 AST 400-15D	400	1.50 mm	5,866	2000136
50 AST 500-15D	500	1.50 mm	7,005	2000138
50 AST 600-15D	600	1.50 mm	8,143	2000140
50 AST 600-15D	600	1.50 mm	8,143	2000140

2.00 mm

Sipariş Kodu Order Code	W (mm)	T (mm)	Ağırlık (kg/m) Weight (kg/m)	Barkod Kodu Barcode Code
50 AST 050-20D	50	2.00 mm	2,507	2000164
50 AST 100-20D	100	2.00 mm	3,327	2000165
50 AST 160-20D	160	2.00 mm	3,831	2000166
50 AST 200-20D	200	2.00 mm	4,871	2000167
50 AST 300-20D	300	2.00 mm	6,305	2000135
50 AST 400-20D	400	2.00 mm	7,827	2000137
50 AST 500-20D	500	2.00 mm	9,343	2000139
50 AST 600-20D	600	2.00 mm	10,853	2000141
50 AST 700-20D	700	2.00 mm	13,026	2000460
50 AST 800-20D	800	2.00 mm	14,667	2000461
50 AST 900-20D	900	2.00 mm	16,308	2000462

H = YÜKSEKLİK = HEIGHT / W = GENİŞLİK = WIDTH / T = KALINLIK = THICKNESS

50 AST 100-10D

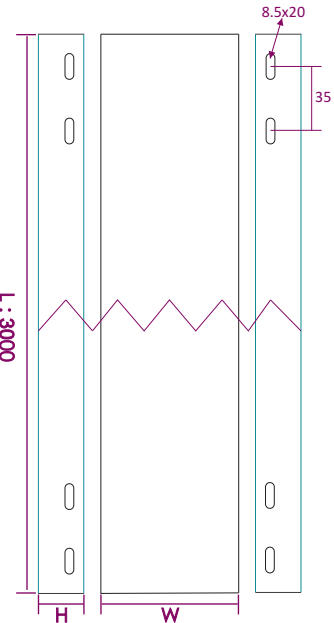
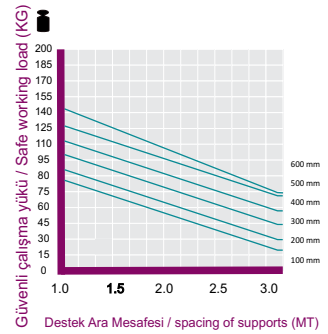

Standart uzunluk L:3000 mm
Toplu miktarlarda Özel ölçüler yapılabilir.
Standard Length L:3000 mm
Custom sizes can be made in bulk quantities.

* Farklı kalınlık ve ölçülerde üretim yapılabılır.
* Malzeme ağırlıkları yaklaşık değerlerdir, ± %10 değişiklik gösterebilir.
* Malzeme kalınlık toleransı ± %10 dur.
* Lütfen siparişlerinizde sipariş kodu veya ürün kodu ve Kaplama şeklini belirtiniz.

* We can produce cable trays different thickness and dimensions
* Cable trays are shown approximately weight, they could change ± %10 difference.
* Cable trays thickness tolerances are shown ± %10 .
* Please indicate order code and coating type in your orders.

H60 AGH SERIES

AGIR HIZMET TIP KABLO KANALI

HEAVY DUTY TYPE CABLE TRAYS

PREGALVANIZ (PG)
PREGALVANIZED (PG)
TS EN 10346

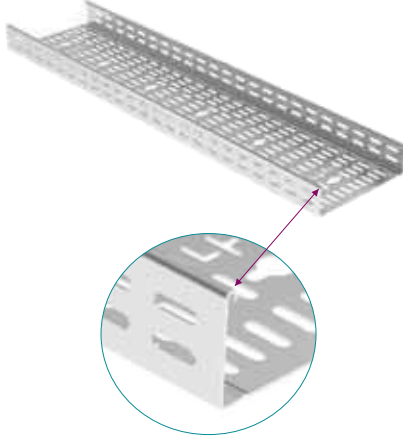

Sipariş Kodu Order Code	W (mm)	T (mm)	Ağırlık (kg/m) Weight (kg/m)	Barkod Kodu Barcode Code
60 AGH 100-08	100	0.80 mm	1,223	2000410
60 AGH 160-08	160	0.80 mm	1,488	2000412
60 AGH 200-09	200	0.90 mm	1,922	2000413

Sipariş Kodu Order Code	W (mm)	T (mm)	Ağırlık (kg/m) Weight (kg/m)	Barkod Kodu Barcode Code
60 AGH 100-10	100	1.00 mm	1,529	2000347
60 AGH 160-10	160	1.00 mm	1,861	2000350
60 AGH 200-10	200	1.00 mm	2,136	2000353
60 AGH 300-10	300	1.00 mm	2,734	2000356

Sipariş Kodu Order Code	W (mm)	T (mm)	Ağırlık (kg/m) Weight (kg/m)	Barkod Kodu Barcode Code
60 AGH 100-12	100	1.20 mm	1,838	2000348
60 AGH 160-12	160	1.20 mm	2,269	2000351
60 AGH 200-12	200	1.20 mm	2,558	2000354
60 AGH 300-12	300	1.20 mm	3,278	2000357
60 AGH 400-12	400	1.20 mm	3,998	2000360
60 AGH 500-12	500	1.20 mm	4,719	2000363

Sipariş Kodu Order Code	W (mm)	T (mm)	Ağırlık (kg/m) Weight (kg/m)	Barkod Kodu Barcode Code
60 AGH 100-15	100	1.50 mm	2,298	2000349
60 AGH 160-15	160	1.50 mm	2,837	2000352
60 AGH 200-15	200	1.50 mm	3,200	2000355
60 AGH 300-15	300	1.50 mm	4,096	2000358
60 AGH 400-15	400	1.50 mm	4,998	2000361
60 AGH 500-15	500	1.50 mm	5,895	2000364
60 AGH 600-15	600	1.50 mm	6,796	2000366

Sipariş Kodu Order Code	W (mm)	T (mm)	Ağırlık (kg/m) Weight (kg/m)	Barkod Kodu Barcode Code
60 AGH 100-20	100	2.00 mm	3,118	2000417
60 AGH 160-20	160	2.00 mm	3,850	2000419
60 AGH 200-20	200	2.00 mm	4,342	2000420
60 AGH 300-20	300	2.00 mm	5,468	2000359
60 AGH 400-20	400	2.00 mm	6,640	2000362
60 AGH 500-20	500	2.00 mm	7,865	2000365
60 AGH 600-20	600	2.00 mm	9,060	2000367
60 AGH 700-20	700	2.00 mm	11,631	2000463
60 AGH 800-20	800	2.00 mm	13,025	2000464
60 AGH 900-20	900	2.00 mm	14,419	2000465

H = YÜKSEKLİK = HEIGHT / W = GENİŞLİK = WIDTH / T = KALINLIK = THICKNESS

0.80 mm

1.00 mm

1.20 mm

1.50 mm

2.00 mm

60 AGH 100 - 10

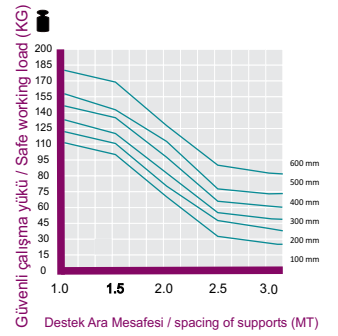

Güvenli çalışma yükü / Safe working load (KG)

Destek Ara Mesafesi / spacing of supports (MT)

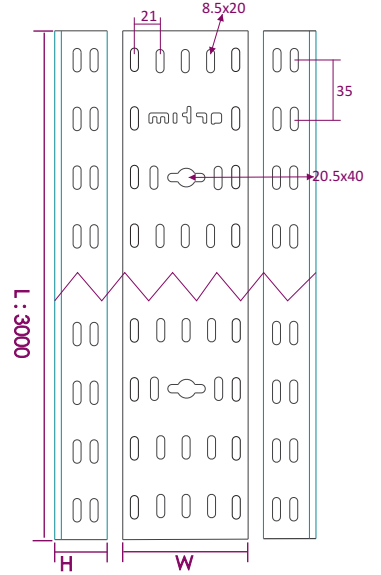

Standart uzunluk L:3000 mm
Toplu miktarlarda Özel ölçüler yapılabilir.
Standard Length L:3000 mm
Custom sizes can be made in bulk quantities.

ARTIM METAL ELEKTRİK A.Ş.

* Farklı kalınlık ve ölçülerde üretim yapılabılır.
* Malzeme ağırlıkları yaklaşık değerlerdir, ± %10 değişiklik gösterebilir.
* Malzeme kalınlık toleransı ± %10 dur.
* Lütfen siparişlerinizde sipariş kodu veya ürün kodu ve Kaplama şeklini belirtiniz.

* We can produce cable trays different thickness and dimensions
* Cable trays are shown approximately weight, they could change ± %10 difference.
* Cable trays thickness tolerances are shown ± %10 .
* Please indicate order code and coating type in your orders.

H60 AGH SERIES

AGIR HIZMET TIP KABLO KANALI

HEAVY DUTY TYPE CABLE TRAYS

SICAK DALDIRMA (SD)

HOT DIP GALVANIZED (HDG)

TS EN ISO 1461

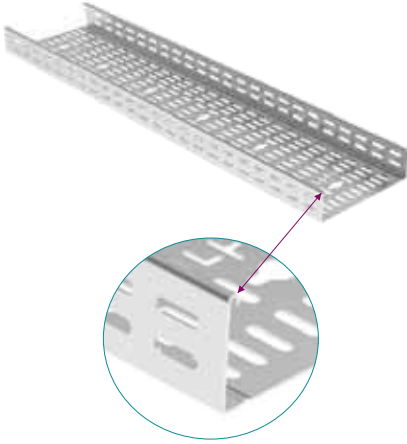

0.80 mm

Sipariş Kodu Order Code	W (mm)	T (mm)	Ağırlık (kg/m) Weight (kg/m)	Barkod Kodu Barcode Code
60 AGH 100-08	100	0.80 mm	1,348	2000410
60 AGH 160-08	160	0.80 mm	1,666	2000412
60 AGH 200-09	200	0.90 mm	2,117	2000413

1.00 mm

Sipariş Kodu Order Code	W (mm)	T (mm)	Ağırlık (kg/m) Weight (kg/m)	Barkod Kodu Barcode Code
60 AGH 100-10	100	1.00 mm	1,686	2000347
60 AGH 160-10	160	1.00 mm	2,083	2000350
60 AGH 200-10	200	1.00 mm	2,352	2000353
60 AGH 300-10	300	1.00 mm	3,009	2000356

1.20 mm

Sipariş Kodu Order Code	W (mm)	T (mm)	Ağırlık (kg/m) Weight (kg/m)	Barkod Kodu Barcode Code
60 AGH 100-12	100	1.20 mm	2,024	2000348
60 AGH 160-12	160	1.20 mm	2,499	2000351
60 AGH 200-12	200	1.20 mm	2,818	2000354
60 AGH 300-12	300	1.20 mm	3,606	2000357
60 AGH 400-12	400	1.20 mm	4,361	2000360
60 AGH 500-12	500	1.20 mm	5,194	2000363

1.50 mm

Sipariş Kodu Order Code	W (mm)	T (mm)	Ağırlık (kg/m) Weight (kg/m)	Barkod Kodu Barcode Code
60 AGH 100-15	100	1.50 mm	2,528	2000349
60 AGH 160-15	160	1.50 mm	3,121	2000352
60 AGH 200-15	200	1.50 mm	3,523	2000355
60 AGH 300-15	300	1.50 mm	4,508	2000358
60 AGH 400-15	400	1.50 mm	5,498	2000361
60 AGH 500-15	500	1.50 mm	6,488	2000364
60 AGH 600-15	600	1.50 mm	7,477	2000366

2.00 mm

Sipariş Kodu Order Code	W (mm)	T (mm)	Ağırlık (kg/m) Weight (kg/m)	Barkod Kodu Barcode Code
60 AGH 100-20	100	2.00 mm	3,430	2000417
60 AGH 160-20	160	2.00 mm	4,235	2000419
60 AGH 200-20	200	2.00 mm	4,781	2000420
60 AGH 300-20	300	2.00 mm	6,170	2000359
60 AGH 400-20	400	2.00 mm	7,306	2000362
60 AGH 500-20	500	2.00 mm	8,653	2000365
60 AGH 600-20	600	2.00 mm	9,967	2000367
60 AGH 700-20	700	2.00 mm	12,794	2000463
60 AGH 800-20	800	2.00 mm	14,328	2000464
60 AGH 900-20	900	2.00 mm	15,861	2000465

H = YÜKSEKLİK = HEIGHT / W = GENİŞLİK = WIDTH / T = KALINLIK = THICKNESS

60 AGH 100 - 10

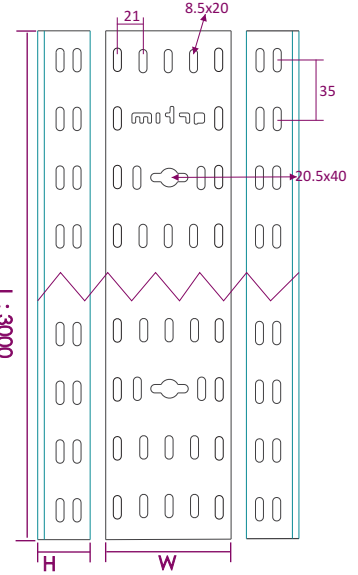
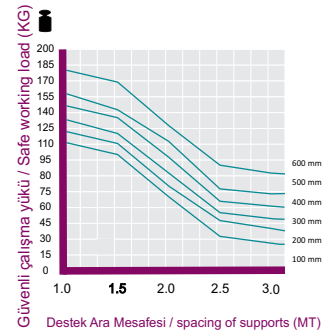
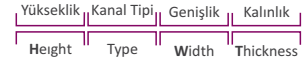

Standart uzunluk L:3000 mm
Toplu miktarlarda Özel ölçüler yapılabilir.
Standard Length L:3000 mm
Custom sizes can be made in bulk quantities.

* Farklı kalınlık ve ölçülerde üretim yapılabılır.
* Malzeme ağırlıkları yaklaşık değerlerdir, ± %10 değişiklik gösterebilir.
* Malzeme kalınlık toleransı ± %10 dur.
* Lütfen siparişlerinizde sipariş kodu veya ürün kodu ve Kaplama şeklini belirtiniz.

* We can produce cable trays different thickness and dimensions
* Cable trays are shown approximately weight, they could change ± %10 difference.
* Cable trays thickness tolerances are shown ± %10 .
* Please indicate order code and coating type in your orders.

H60 AGH SERIES

AGIR HIZMET TIP KABLO KANALI (DELIKSIZ)

HEAVY DUTY TYPE CABLE TRAYS (NON PERFORATED)

PREGALVANIZ (PG)
PREGALVANIZED (PG)
TS EN 10346



0.80 mm

Sipariş Kodu Order Code	W (mm)	T (mm)	Ağırlık (kg/m) Weight (kg/m)	Barkod Kodu Barcode Code
60 AGH 100-08D	100	0.80 mm	1,406	2000410
60 AGH 160-08D	160	0.80 mm	1,711	2000412
60 AGH 200-09D	200	0.90 mm	2,210	2000413

1.00 mm

Sipariş Kodu Order Code	W (mm)	T (mm)	Ağırlık (kg/m) Weight (kg/m)	Barkod Kodu Barcode Code
60 AGH 100-10D	100	1.00 mm	1,758	2000347
60 AGH 160-10D	160	1.00 mm	2,140	2000350
60 AGH 200-10D	200	1.00 mm	2,456	2000353
60 AGH 300-10D	300	1.00 mm	3,144	2000356

1.20 mm

Sipariş Kodu Order Code	W (mm)	T (mm)	Ağırlık (kg/m) Weight (kg/m)	Barkod Kodu Barcode Code
60 AGH 100-12D	100	1.20 mm	2,114	2000348
60 AGH 160-12D	160	1.20 mm	2,609	2000351
60 AGH 200-12D	200	1.20 mm	2,942	2000354
60 AGH 300-12D	300	1.20 mm	3,770	2000357
60 AGH 400-12D	400	1.20 mm	4,598	2000360
60 AGH 500-12D	500	1.20 mm	5,427	2000363

1.50 mm

Sipariş Kodu Order Code	W (mm)	T (mm)	Ağırlık (kg/m) Weight (kg/m)	Barkod Kodu Barcode Code
60 AGH 100-15D	100	1.50 mm	2,643	2000349
60 AGH 160-15D	160	1.50 mm	3,263	2000352
60 AGH 200-15D	200	1.50 mm	3,680	2000355
60 AGH 300-15D	300	1.50 mm	4,710	2000358
60 AGH 400-15D	400	1.50 mm	5,748	2000361
60 AGH 500-15D	500	1.50 mm	6,779	2000364
60 AGH 600-15D	600	1.50 mm	7,815	2000366

2.00 mm

Sipariş Kodu Order Code	W (mm)	T (mm)	Ağırlık (kg/m) Weight (kg/m)	Barkod Kodu Barcode Code
60 AGH 100-20D	100	2.00 mm	3,586	2000417
60 AGH 160-20D	160	2.00 mm	4,428	2000419
60 AGH 200-20D	200	2.00 mm	4,993	2000420
60 AGH 300-20D	300	2.00 mm	6,288	2000359
60 AGH 400-20D	400	2.00 mm	7,636	2000362
60 AGH 500-20D	500	2.00 mm	9,045	2000365
60 AGH 600-20D	600	2.00 mm	10,419	2000367
60 AGH 700-20D	700	2.00 mm	12,439	2000466
60 AGH 800-20D	800	2.00 mm	13,931	2000467
60 AGH 900-20D	900	2.00 mm	15,422	2000468

H = YÜKSEKLİK = HEIGHT / W = GENİŞLİK = WIDTH / T = KALINLIK = THICKNESS

60 AGH 100-10D

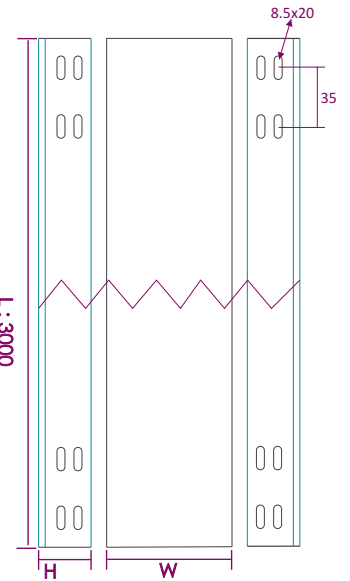
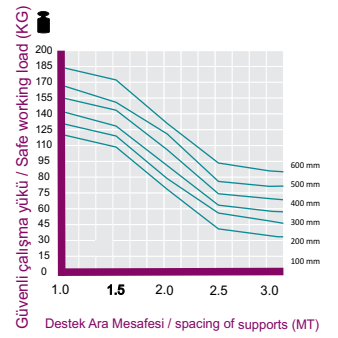

Standart uzunluk L:3000 mm
Toplu miktarlarda Özel ölçüler yapılabilir.
Standard Length L:3000 mm
Custom sizes can be made in bulk quantities.

ARTIM METAL ELEKTRİK A.Ş.

* Farklı kalınlık ve ölçülerde üretim yapılabılır.
* Malzeme ağırlıkları yaklaşık değerlerdir, \pm %10 değişiklik gösterebilir.
* Malzeme kalınlık toleransı \pm %10 dur.
* Lütfen siparişlerinizde sipariş kodu veya ürün kodu ve Kaplama şeklini belirtiniz.

* We can produce cable trays different thickness and dimensions
* Cable trays are shown approximately weight, they could change \pm %10 difference.
* Cable trays thickness tolerances are shown \pm %10 .
* Please indicate order code and coating type in your orders.

H60 AGH SERIES

AGIR HIZMET TIP KABLO KANALI (DELIKSIZ)

HEAVY DUTY TYPE CABLE TRAYS (NON PERFORATE)

SICAK DALDIRMA (SD)

HOT DIP GALVANIZED (HDG)

TS EN ISO 1461



0.80 mm

Sipariş Kodu Order Code	W (mm)	T (mm)	Ağırlık (kg/m) Weight (kg/m)	Barkod Kodu Barcode Code
60 AGH 100-08D	100	0.80 mm	1,550	2000410
60 AGH 160-08D	160	0.80 mm	1,916	2000412
60 AGH 200-09D	200	0.90 mm	2,435	2000413

1.00 mm

Sipariş Kodu Order Code	W (mm)	T (mm)	Ağırlık (kg/m) Weight (kg/m)	Barkod Kodu Barcode Code
60 AGH 100-10D	100	1.00 mm	1,939	2000347
60 AGH 160-10D	160	1.00 mm	2,395	2000350
60 AGH 200-10D	200	1.00 mm	2,705	2000353
60 AGH 300-10D	300	1.00 mm	3,460	2000356

1.20 mm

Sipariş Kodu Order Code	W (mm)	T (mm)	Ağırlık (kg/m) Weight (kg/m)	Barkod Kodu Barcode Code
60 AGH 100-12D	100	1.20 mm	2,328	2000348
60 AGH 160-12D	160	1.20 mm	2,874	2000351
60 AGH 200-12D	200	1.20 mm	3,241	2000354
60 AGH 300-12D	300	1.20 mm	4,147	2000357
60 AGH 400-12D	400	1.20 mm	5,015	2000360
60 AGH 500-12D	500	1.20 mm	5,973	2000363

1.50 mm

Sipariş Kodu Order Code	W (mm)	T (mm)	Ağırlık (kg/m) Weight (kg/m)	Barkod Kodu Barcode Code
60 AGH 100-15D	100	1.50 mm	2,907	2000349
60 AGH 160-15D	160	1.50 mm	3,589	2000352
60 AGH 200-15D	200	1.50 mm	4,051	2000355
60 AGH 300-15D	300	1.50 mm	5,184	2000358
60 AGH 400-15D	400	1.50 mm	6,323	2000361
60 AGH 500-15D	500	1.50 mm	7,461	2000364
60 AGH 600-15D	600	1.50 mm	8,599	2000366

2.00 mm

Sipariş Kodu Order Code	W (mm)	T (mm)	Ağırlık (kg/m) Weight (kg/m)	Barkod Kodu Barcode Code
60 AGH 100-20D	100	2.00 mm	3,945	2000417
60 AGH 160-20D	160	2.00 mm	4,870	2000419
60 AGH 200-20D	200	2.00 mm	5,498	2000420
60 AGH 300-20D	300	2.00 mm	7,096	2000359
60 AGH 400-20D	400	2.00 mm	8,402	2000362
60 AGH 500-20D	500	2.00 mm	9,951	2000365
60 AGH 600-20D	600	2.00 mm	11,462	2000367
60 AGH 700-20D	700	2.00 mm	13,683	2000466
60 AGH 800-20D	800	2.00 mm	15,324	2000467
60 AGH 900-20D	900	2.00 mm	16,964	2000468

H = YÜKSEKLİK = HEIGHT / W = GENİŞLİK = WIDTH / T = KALINLIK = THICKNESS

60 AGH 100-10D

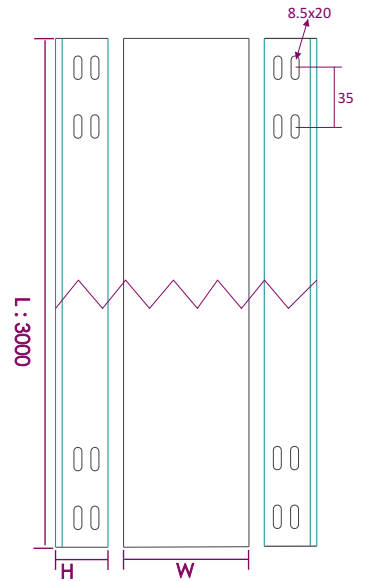
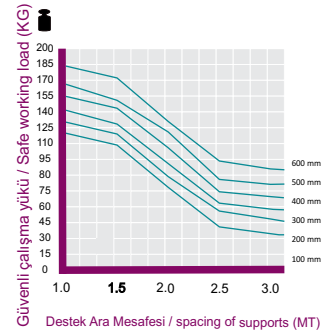

Standart uzunluk L:3000 mm
Toplu miktarlarda Özel ölçüler yapılabilir.
Standard Length L:3000 mm
Custom sizes can be made in bulk quantities.

* Farklı kalınlık ve ölçülerde üretim yapılabılır.
* Malzeme ağırlıkları yaklaşık değerlerdir, \pm %10 değişiklik gösterebilir.
* Malzeme kalınlık toleransı \pm %10 dur.
* Lütfen siparişlerinizde sipariş kodu veya ürün kodu ve Kaplama şeklini belirtiniz.

* We can produce cable trays different thickness and dimensions
* Cable trays are shown approximately weight, they could change \pm %10 difference.
* Cable trays thickness tolerances are shown \pm %10 .
* Please indicate order code and coating type in your orders.

H60 AST SERIES

STANDART TIP KABLO KANALI

MEDIUM DUTY CABLE TRAYS

PREGALVANİZ (PG)
PREGALVANIZED (PG)
TS EN 10346

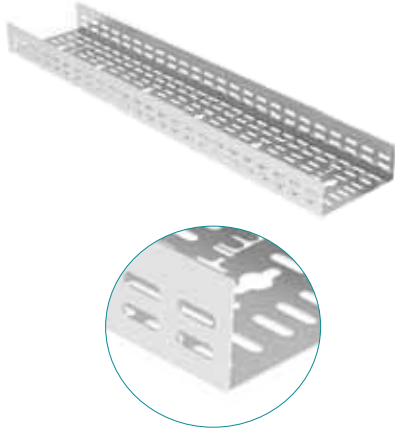

1.00 mm

Sipariş Kodu Order Code	W (mm)	T (mm)	Ağırlık (kg/m) Weight (kg/m)	Barkod Kodu Barcode Code
60 AST 100-10	100	1.00 mm	1,451	2000168
60 AST 160-10	160	1.00 mm	1,911	2000170
60 AST 200-10	200	1.00 mm	2,048	2000171

1.20 mm

Sipariş Kodu Order Code	W (mm)	T (mm)	Ağırlık (kg/m) Weight (kg/m)	Barkod Kodu Barcode Code
60 AST 100-12	100	1.20 mm	1,736	2000172
60 AST 160-12	160	1.20 mm	2,293	2000174
60 AST 200-12	200	1.20 mm	2,457	2000175
60 AST 300-12	300	1.20 mm	3,177	2000176

1.50 mm

Sipariş Kodu Order Code	W (mm)	T (mm)	Ağırlık (kg/m) Weight (kg/m)	Barkod Kodu Barcode Code
60 AST 100-15	100	1.50 mm	2,156	2000177
60 AST 160-15	160	1.50 mm	2,676	2000179
60 AST 200-15	200	1.50 mm	3,057	2000180
60 AST 300-15	300	1.50 mm	3,959	2000181
60 AST 400-15	400	1.50 mm	4,855	2000182
60 AST 500-15	500	1.50 mm	5,757	2000183
60 AST 600-15	600	1.50 mm	6,654	2000184

2.00 mm

Sipariş Kodu Order Code	W (mm)	T (mm)	Ağırlık (kg/m) Weight (kg/m)	Barkod Kodu Barcode Code
60 AST 100-20	100	2.00 mm	2,925	2000185
60 AST 160-20	160	2.00 mm	3,631	2000187
60 AST 200-20	200	2.00 mm	4,148	2000188
60 AST 300-20	300	2.00 mm	5,281	2000189
60 AST 400-20	400	2.00 mm	6,482	2000190
60 AST 500-20	500	2.00 mm	7,682	2000191
60 AST 600-20	600	2.00 mm	8,878	2000192
60 AST 700-20	700	2.00 mm	11,352	2000469
60 AST 800-20	800	2.00 mm	12,745	2000470
60 AST 900-20	900	2.00 mm	14,141	2000471

H = YÜKSEKLİK = HEIGHT / W = GENİŞLİK = WIDTH / T = KALINLIK = THICKNESS

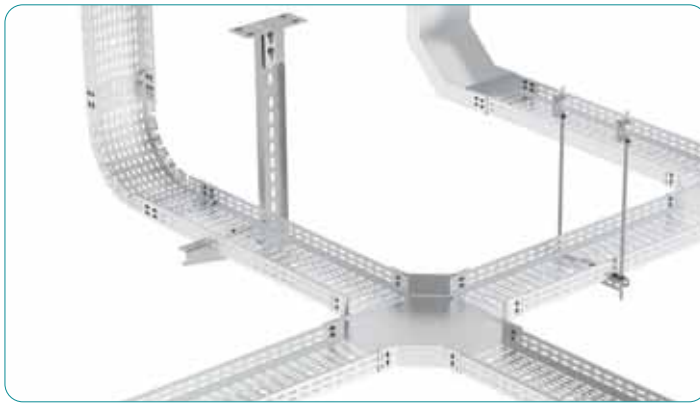

60 AST 100-10

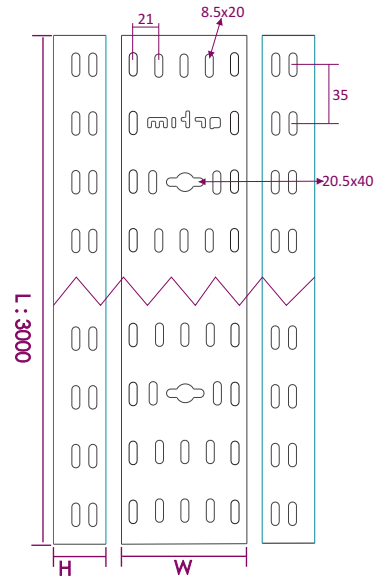
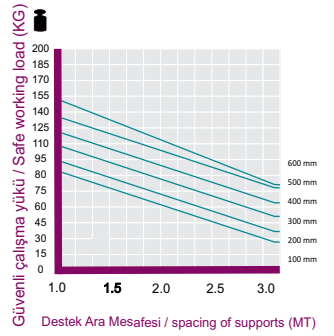

Standart uzunluk L:3000 mm
Toplu miktarlarda Özel ölçüler yapılabilir.
Standard Length L:3000 mm
Custom sizes can be made in bulk quantities.

ARTIM METAL ELEKTRİK A.Ş.

- * Farklı kalınlık ve ölçülerde üretim yapılabılır.
- * Malzeme ağırlıkları yaklaşık değerlerdir, \pm %10 değişiklik gösterebilir.
- * Malzeme kalınlık toleransı \pm %10 dur.
- * Lütfen siparişlerinizde sipariş kodu veya ürün kodu ve Kaplama şeklini belirtiniz.

- * We can produce cable trays different thickness and dimensions
- * Cable trays are shown approximately weight, they could change \pm %10 difference.
- * Cable trays thickness tolerances are shown \pm %10 .
- * Please indicate order code and coating type in your orders.

H60 AST SERIES

STANDART TIP KABLO KANALI

MEDIUM DUTY CABLE TRAYS

SICAK DALDIRMA (SD)

HOT DIP GALVANIZED (HDG)

TS EN ISO 1461

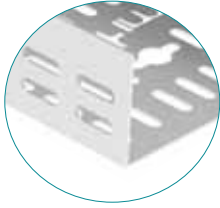

1.00 mm

Sipariş Kodu Order Code	W (mm)	T (mm)	Ağırlık (kg/m) Weight (kg/m)	Barkod Kodu Barcode Code
60 AST 100-10	100	1.00 mm	1,591	2000169
60 AST 160-10	160	1.00 mm	1,925	2000171
60 AST 200-10	200	1.00 mm	2,253	2000172

1.20 mm

Sipariş Kodu Order Code	W (mm)	T (mm)	Ağırlık (kg/m) Weight (kg/m)	Barkod Kodu Barcode Code
60 AST 100-12	100	1.20 mm	1,910	2000174
60 AST 160-12	160	1.20 mm	2,310	2000176
60 AST 200-12	200	1.20 mm	2,704	2000177
60 AST 300-12	300	1.20 mm	3,493	2000178

1.50 mm

Sipariş Kodu Order Code	W (mm)	T (mm)	Ağırlık (kg/m) Weight (kg/m)	Barkod Kodu Barcode Code
60 AST 100-15	100	1.50 mm	2,372	2000179
60 AST 160-15	160	1.50 mm	2,695	2000181
60 AST 200-15	200	1.50 mm	3,361	2000182
60 AST 300-15	300	1.50 mm	4,351	2000183
60 AST 400-15	400	1.50 mm	5,341	2000184
60 AST 500-15	500	1.50 mm	6,331	2000185
60 AST 600-15	600	1.50 mm	7,321	2000186

2.00 mm

Sipariş Kodu Order Code	W (mm)	T (mm)	Ağırlık (kg/m) Weight (kg/m)	Barkod Kodu Barcode Code
60 AST 100-20	100	2.00 mm	3,218	2000188
60 AST 160-20	160	2.00 mm	3,656	2000190
60 AST 200-20	200	2.00 mm	4,561	2000191
60 AST 300-20	300	2.00 mm	5,808	2000192
60 AST 400-20	400	2.00 mm	7,131	2000193
60 AST 500-20	500	2.00 mm	8,449	2000194
60 AST 600-20	600	2.00 mm	9,762	2000195
60 AST 700-20	700	2.00 mm	12,487	2000469
60 AST 800-20	800	2.00 mm	14,020	2000470
60 AST 900-20	900	2.00 mm	15,555	2000471

H = YÜKSEKLİK = HEIGHT / W = GENİŞLİK = WIDTH / T = KALINLIK = THICKNESS



60 AST 100-10

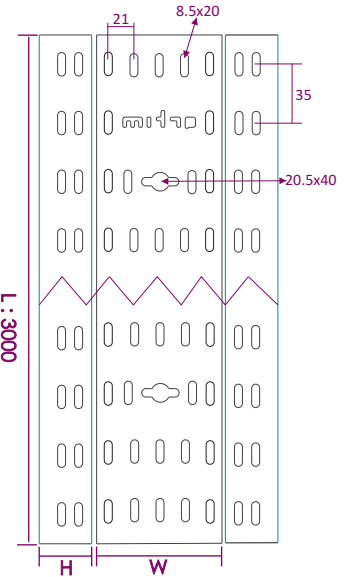
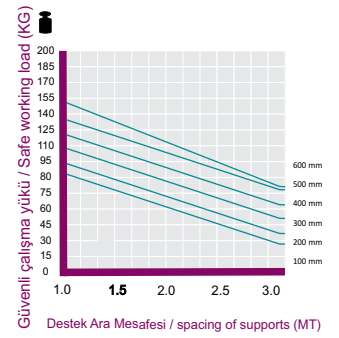

Standart uzunluk L:3000 mm
Toplu miktarlarda Özel ölçüler yapılabilir.
Standard Length L:3000 mm
Custom sizes can be made in bulk quantities.

* Farklı kalınlık ve ölçülerde üretim yapılabılır.
* Malzeme ağırlıkları yaklaşık değerlerdir, \pm %10 değişiklik gösterebilir.
* Malzeme kalınlık toleransı \pm %10 dur.
* Lütfen siparişlerinizde sipariş kodu veya ürün kodu ve kaplama şeklini belirtiniz.

* We can produce cable trays different thickness and dimensions
* Cable trays are shown approximately weight, they could change \pm %10 difference.
* Cable trays thickness tolerances are shown \pm %10 .
* Please indicate order code and coating type in your orders.

H60 AST SERIES

STANDART TIP KABLO KANALI (DELİKSİZ)

MEDIUM DUTY CABLE TRAYS (NON PERFORATED)

PREGALVANİZ (PG)
PREGALVANIZED (PG)
TS EN 10346

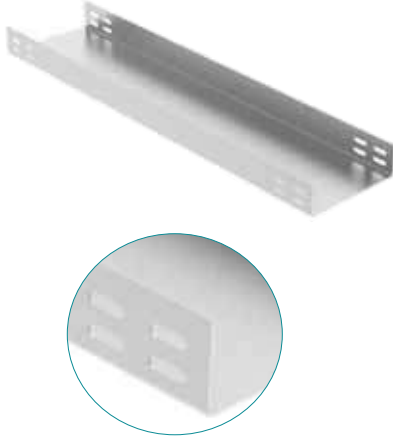

1.50 mm

Sipariş Kodu Order Code	W (mm)	T (mm)	Ağırlık (kg/m) Weight (kg/m)	Barkod Kodu Barcode Code
60 AST 100-15D	100	1.50 mm	2,479	2000177
60 AST 160-15D	160	1.50 mm	3,077	2000179
60 AST 200-15D	200	1.50 mm	3,516	2000180
60 AST 300-15D	300	1.50 mm	4,553	2000181
60 AST 400-15D	400	1.50 mm	5,583	2000182
60 AST 500-15D	500	1.50 mm	6,621	2000183
60 AST 600-15D	600	1.50 mm	7,652	2000184

2.00 mm

Sipariş Kodu Order Code	W (mm)	T (mm)	Ağırlık (kg/m) Weight (kg/m)	Barkod Kodu Barcode Code
60 AST 100-20D	100	2.00 mm	3,364	2000185
60 AST 160-20D	160	2.00 mm	4,176	2000187
60 AST 200-20D	200	2.00 mm	4,770	2000188
60 AST 300-20D	300	2.00 mm	6,073	2000189
60 AST 400-20D	400	2.00 mm	7,454	2000190
60 AST 500-20D	500	2.00 mm	8,834	2000191
60 AST 600-20D	600	2.00 mm	10,210	2000192
60 AST 700-20D	700	2.00 mm	12,141	2000472
60 AST 800-20D	800	2.00 mm	13,632	2000473
60 AST 900-20D	900	2.00 mm	15,124	2000474

H = YÜKSEKLİK = HEIGHT / W = GENİŞLİK = WIDTH / T = KALINLIK = THICKNESS

60 AST 100-10D

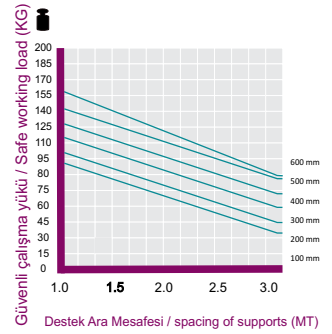

SICAK DALDIRMA (SD)
HOT DIP GALVANIZED (HDG)
TS EN ISO 1461

1.50 mm

Sipariş Kodu Order Code	W (mm)	T (mm)	Ağırlık (kg/m) Weight (kg/m)	Barkod Kodu Barcode Code
60 AST 100-15D	100	1.50 mm	2,728	2000179
60 AST 160-15D	160	1.50 mm	3,099	2000181
60 AST 200-15D	200	1.50 mm	3,865	2000182
60 AST 300-15D	300	1.50 mm	5,004	2000183
60 AST 400-15D	400	1.50 mm	6,142	2000184
60 AST 500-15D	500	1.50 mm	7,281	2000185
60 AST 600-15D	600	1.50 mm	8,419	2000186

2.00 mm

Sipariş Kodu Order Code	W (mm)	T (mm)	Ağırlık (kg/m) Weight (kg/m)	Barkod Kodu Barcode Code
60 AST 100-20D	100	2.00 mm	3,701	2000188
60 AST 160-20D	160	2.00 mm	4,204	2000190
60 AST 200-20D	200	2.00 mm	5,245	2000191
60 AST 300-20D	300	2.00 mm	6,679	2000192
60 AST 400-20D	400	2.00 mm	8,201	2000193
60 AST 500-20D	500	2.00 mm	9,716	2000194
60 AST 600-20D	600	2.00 mm	11,226	2000195
60 AST 700-20D	700	2.00 mm	13,355	2000472
60 AST 800-20D	800	2.00 mm	14,995	2000473
60 AST 900-20D	900	2.00 mm	16,636	2000474

H = YÜKSEKLİK = HEIGHT / W = GENİŞLİK = WIDTH / T = KALINLIK = THICKNESS

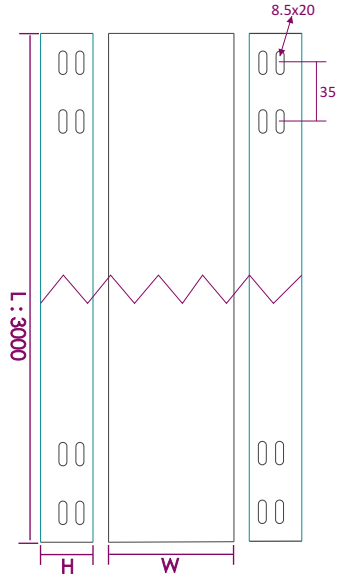

Standart uzunluk L:3000 mm
Toplu miktarlarda Özel ölçüler yapılabilir.
Standard Length L:3000 mm
Custom sizes can be made in bulk quantities.

ARTIM METAL ELEKTRİK A.Ş.

* Farklı kalınlık ve ölçülerde üretim yapılabılır.
* Malzeme ağırlıkları yaklaşık değerlerdir, ± %10 değişiklik gösterebilir.
* Malzeme kalınlık toleransı ± %10 dur.
* Lütfen siparişlerinizde sipariş kodu veya ürün kodu ve Kaplama şeklini belirtiniz.

* We can produce cable trays different thickness and dimensions
* Cable trays are shown approximately weight, they could change ± %10 difference.
* Cable trays thickness tolerances are shown ± %10 .
* Please indicate order code and coating type in your orders.

AGH SERIES

ÖZEL KABLO KANALLARI

SPECIAL CABLE TRAYS

SICAK DALDIRMA (SD)

HOT DIP GALVANIZED (HDG)

TS EN ISO 1461

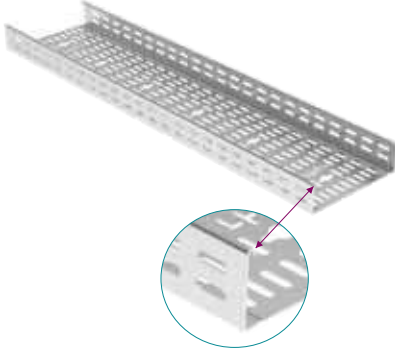

1.50 mm

Sipariş Kodu Order Code	W (mm)	T (mm)	Ağırlık (kg/m) Weight (kg/m)	Barkod Kodu Barcode Code
75 AGH 100-15	100	1.50 mm	2,745	2000501
75 AGH 200-15	200	1.50 mm	3,740	2000502
75 AGH 300-15	300	1.50 mm	4,712	2000503
75 AGH 400-15	400	1.50 mm	5,659	2000504
75 AGH 500-15	500	1.50 mm	6,662	2000505
75 AGH 600-15	600	1.50 mm	7,666	2000506

75 AGH 200-15



Standart uzunluk L:3000 mm
Toplu miktarlarda Özel ölçüler yapılabilir.
Standard Length L:3000 mm
Custom sizes can be made in bulk quantities.

2.00 mm

Sipariş Kodu Order Code	W (mm)	T (mm)	Ağırlık (kg/m) Weight (kg/m)	Barkod Kodu Barcode Code
75 AGH 100-20	100	2.00 mm	3,725	2000507
75 AGH 200-20	200	2.00 mm	5,076	2000508
75 AGH 300-20	300	2.00 mm	6,395	2000509
75 AGH 400-20	400	2.00 mm	7,680	2000510
75 AGH 500-20	500	2.00 mm	9,042	2000511
75 AGH 600-20	600	2.00 mm	10,404	2000512

H = YÜKSEKLİK = HEIGHT / W = GENİŞLİK = WIDTH / T = KALINLIK = THICKNESS

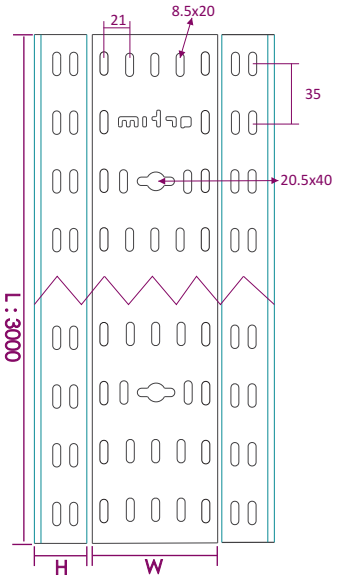

1.50 mm

Sipariş Kodu Order Code	W (mm)	T (mm)	Ağırlık (kg/m) Weight (kg/m)	Barkod Kodu Barcode Code
80 AGH 100-15Z	100	1.50 mm	3,519	2000513
80 AGH 200-15Z	200	1.50 mm	4,715	2000514
80 AGH 300-15Z	300	1.50 mm	5,912	2000515
80 AGH 400-15Z	400	1.50 mm	7,109	2000516
80 AGH 500-15Z	500	1.50 mm	8,306	2000517
80 AGH 600-15Z	600	1.50 mm	9,503	2000518

2.00 mm

Sipariş Kodu Order Code	W (mm)	T (mm)	Ağırlık (kg/m) Weight (kg/m)	Barkod Kodu Barcode Code
80 AGH 100-20Z	100	2.00 mm	4,775	2000519
80 AGH 200-20Z	200	2.00 mm	6,400	2000520
80 AGH 300-20Z	300	2.00 mm	8,024	2000521
80 AGH 400-20Z	400	2.00 mm	9,648	2000522
80 AGH 500-20Z	500	2.00 mm	11,272	2000523
80 AGH 600-20Z	600	2.00 mm	12,896	2000524

H = YÜKSEKLİK = HEIGHT / W = GENİŞLİK = WIDTH / T = KALINLIK = THICKNESS



Standart uzunluk L:3000 mm
Toplu miktarlarda Özel ölçüler yapılabilir.
Standard Length L:3000 mm
Custom sizes can be made in bulk quantities.

1.50 mm

Sipariş Kodu Order Code	W (mm)	T (mm)	Ağırlık (kg/m) Weight (kg/m)	Barkod Kodu Barcode Code
AKK 140-15Z	140	1.50 mm	1,975	2000525
AKK 240-15Z	240	1.50 mm	3,172	2000526
AKK 340-15Z	340	1.50 mm	4,368	2000527
AKK 440-15Z	440	1.50 mm	5,565	2000528
AKK 540-15Z	540	1.50 mm	6,762	2000529
AKK 640-15Z	640	1.50 mm	7,959	2000530



* Farklı kalınlık ve ölçülerde üretim yapılabılır.
* Malzeme ağırlıkları yaklaşık değerlerdir, ± %10 değişiklik gösterebilir.
* Malzeme kalınlık toleransı ± %10 dur.
* Lütfen siparişlerinizde sipariş kodu veya ürün kodu ve Kaplama şeklini belirtiniz.

* We can produce cable trays different thickness and dimensions
* Cable trays are shown approximately weight, they could change ± %10 difference.
* Cable trays thickness tolerances are shown ± %10 .
* Please indicate order code and coating type in your orders.

H100 AGH SERIES

AGIR HIZMET TIP KABLO KANALI

HEAVY DUTY TYPE CABLE TRAYS

PREGALVANIZ (PG)
PREGALVANIZED (PG)
TS EN 10346

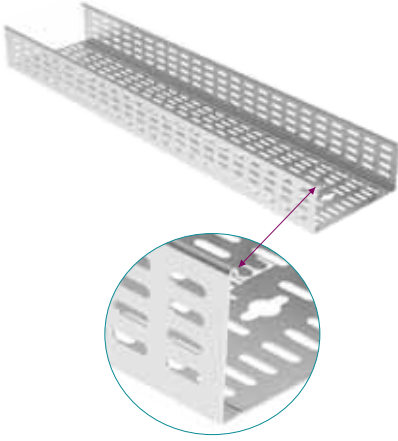

1.00 mm

Sipariş Kodu Order Code	W (mm)	T (mm)	Ağırlık (kg/m) Weight (kg/m)	Barkod Kodu Barcode Code
100 AGH 100-10	100	1.00 mm	1,995	2000475
100 AGH 160-10	160	1.00 mm	2,377	2000477
100 AGH 200-10	200	1.00 mm	2,590	2000478
100 AGH 300-10	300	1.00 mm	3,190	2000479
100 AGH 400-10	400	1.00 mm	3,780	2000480

1.20 mm

Sipariş Kodu Order Code	W (mm)	T (mm)	Ağırlık (kg/m) Weight (kg/m)	Barkod Kodu Barcode Code
100 AGH 100-12	100	1.20 mm	2,395	2000421
100 AGH 160-12	160	1.20 mm	2,853	2000423
100 AGH 200-12	200	1.20 mm	3,108	2000424
100 AGH 300-12	300	1.20 mm	3,828	2000425
100 AGH 400-12	400	1.20 mm	4,536	2000426
100 AGH 500-12	500	1.20 mm	5,250	2000427

1.50 mm

Sipariş Kodu Order Code	W (mm)	T (mm)	Ağırlık (kg/m) Weight (kg/m)	Barkod Kodu Barcode Code
100 AGH 100-15	100	1.50 mm	2,994	2000368
100 AGH 160-15	160	1.50 mm	3,567	2000370
100 AGH 200-15	200	1.50 mm	3,886	2000372
100 AGH 300-15	300	1.50 mm	4,782	2000374
100 AGH 400-15	400	1.50 mm	5,670	2000429
100 AGH 500-15	500	1.50 mm	6,563	2000430
100 AGH 600-15	600	1.50 mm	7,456	2000431

2.00 mm

Sipariş Kodu Order Code	W (mm)	T (mm)	Ağırlık (kg/m) Weight (kg/m)	Barkod Kodu Barcode Code
100 AGH 100-20	100	2.00 mm	3,994	2000369
100 AGH 160-20	160	2.00 mm	4,756	2000371
100 AGH 200-20	200	2.00 mm	5,184	2000373
100 AGH 300-20	300	2.00 mm	6,375	2000375
100 AGH 400-20	400	2.00 mm	7,561	2000376
100 AGH 500-20	500	2.00 mm	8,751	2000377
100 AGH 600-20	600	2.00 mm	9,942	2000378
100 AGH 700-20	700	2.00 mm	11,587	2000486
100 AGH 800-20	800	2.00 mm	12,855	2000487
100 AGH 900-20	900	2.00 mm	14,123	2000488

H = YÜKSEKLİK = HEIGHT / W = GENİŞLİK = WIDTH / T = KALINLIK = THICKNESS

100 AGH 100 - 10

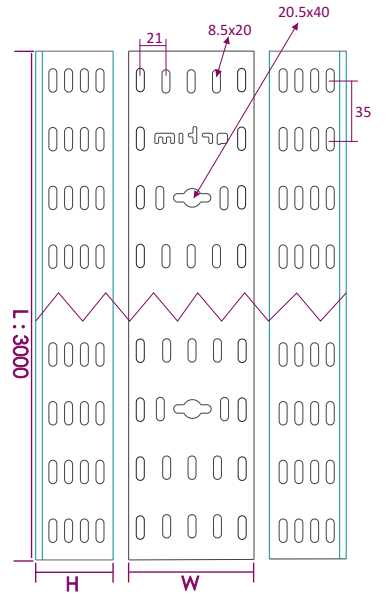
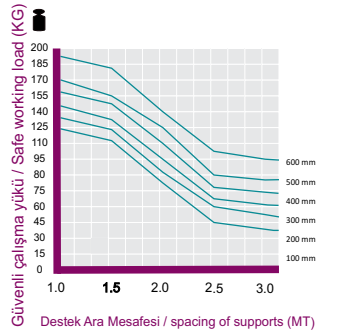
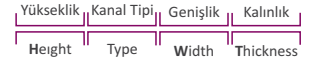

Standart uzunluk L:3000 mm
Toplu miktarlarda Özel ölçüler yapılabilir.
Standard Length L:3000 mm
Custom sizes can be made in bulk quantities.

ARTIM METAL ELEKTRİK A.Ş.

* Farklı kalınlık ve ölçülerde üretim yapılabılır.
* Malzeme ağırlıkları yaklaşık değerlerdir, \pm %10 değişiklik gösterebilir.
* Malzeme kalınlık toleransı \pm %10 dur.
* Lütfen siparişlerinizde sipariş kodu veya ürün kodu ve Kaplama şeklini belirtiniz.

* We can produce cable trays different thickness and dimensions
* Cable trays are shown approximately weight, they could change \pm %10 difference.
* Cable trays thickness tolerances are shown \pm %10 .
* Please indicate order code and coating type in your orders.

H100 AGH SERIES

AGIR HIZMET TIP KABLO KANALI

HEAVY DUTY TYPE CABLE TRAYS

SICAK DALDIRMA (SD)
HOT DIP GALVANIZED (SD)
TS EN ISO 1461

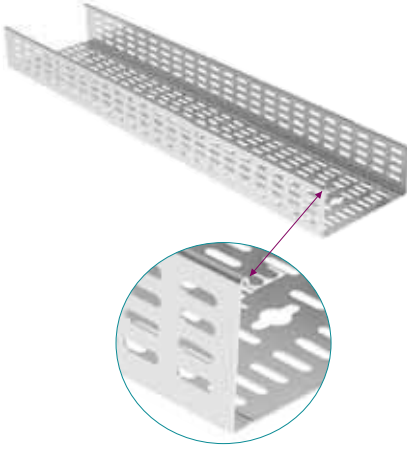

Sipariş Kodu Order Code	W (mm)	T (mm)	Ağırlık (kg/m) Weight (kg/m)	Barkod Kodu Barcode Code
100 AGH 100-10	100	1.00 mm	2,175	2000475
100 AGH 160-10	160	1.00 mm	2,590	2000477
100 AGH 200-10	200	1.00 mm	2,822	2000478
100 AGH 300-10	300	1.00 mm	3,476	2000479
100 AGH 400-10	400	1.00 mm	4,120	2000480

Sipariş Kodu Order Code	W (mm)	T (mm)	Ağırlık (kg/m) Weight (kg/m)	Barkod Kodu Barcode Code
100 AGH 100-12	100	1.20 mm	2,610	2000421
100 AGH 160-12	160	1.20 mm	3,109	2000423
100 AGH 200-12	200	1.20 mm	3,387	2000424
100 AGH 300-12	300	1.20 mm	4,172	2000425
100 AGH 400-12	400	1.20 mm	4,944	2000426
100 AGH 500-12	500	1.20 mm	5,722	2000427

Sipariş Kodu Order Code	W (mm)	T (mm)	Ağırlık (kg/m) Weight (kg/m)	Barkod Kodu Barcode Code
100 AGH 100-15	100	1.50 mm	3,293	2000368
100 AGH 160-15	160	1.50 mm	3,888	2000370
100 AGH 200-15	200	1.50 mm	4,278	2000372
100 AGH 300-15	300	1.50 mm	5,263	2000374
100 AGH 400-15	400	1.50 mm	6,180	2000429
100 AGH 500-15	500	1.50 mm	7,221	2000430
100 AGH 600-15	600	1.50 mm	8,202	2000431

Sipariş Kodu Order Code	W (mm)	T (mm)	Ağırlık (kg/m) Weight (kg/m)	Barkod Kodu Barcode Code
100 AGH 100-20	100	2.00 mm	4,395	2000369
100 AGH 160-20	160	2.00 mm	5,184	2000371
100 AGH 200-20	200	2.00 mm	5,704	2000373
100 AGH 300-20	300	2.00 mm	7,012	2000375
100 AGH 400-20	400	2.00 mm	8,320	2000376
100 AGH 500-20	500	2.00 mm	9,629	2000377
100 AGH 600-20	600	2.00 mm	10,937	2000378
100 AGH 700-20	700	2.00 mm	12,746	2000486
100 AGH 800-20	800	2.00 mm	14,140	2000487
100 AGH 900-20	900	2.00 mm	15,535	2000488

H = YÜKSEKLİK = HEIGHT / W = GENİŞLİK = WIDTH / T = KALINLIK = THICKNESS

100 AGH 100 - 10

Yükseklik Kanal Tipi Genişlik Kalınlık
Height Type Width Thickness

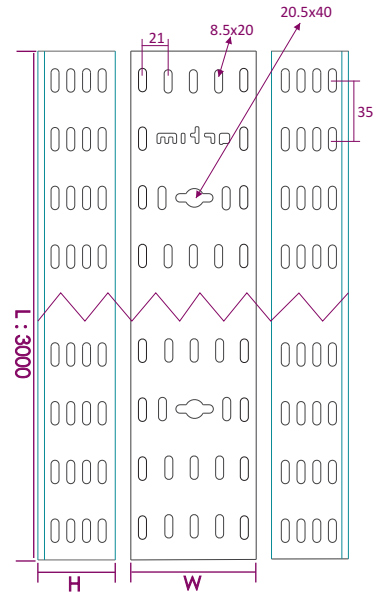
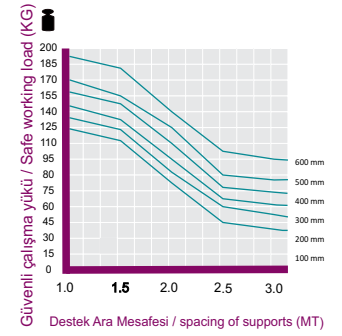

Standart uzunluk L:3000 mm
Toplu miktarlarda Özel ölçüler yapılabilir.
Standard Length L:3000 mm
Custom sizes can be made in bulk quantities.

* Farklı kalınlık ve ölçülerde üretim yapılabılır.
* Malzeme ağırlıkları yaklaşık değerlerdir, ± %10 değişiklik gösterebilir.
* Malzeme kalınlık toleransı ± %10 dur.
* Lütfen siparişlerinizde sipariş kodu veya ürün kodu ve Kaplama şeklini belirtiniz.

* We can produce cable trays different thickness and dimensions
* Cable trays are shown approximately weight, they could change ± %10 difference.
* Cable trays thickness tolerances are shown ± %10 .
* Please indicate order code and coating type in your orders.

H100 AGH SERIES

AGIR HIZMET KABLO KANALI (DELIKSİZ)

HEAVY DUTY TYPE CABLE TRAYS (NON PERFORATED)

PREGALVANIZ (PG)
PREGALVANIZED (PG)
TS EN 10346



1.00 mm

Sipariş Kodu Order Code	W (mm)	T (mm)	Ağırlık (kg/m) Weight (kg/m)	Barkod Kodu Barcode Code
100 AGH 100-10D	100	1.00 mm	2,295	2000481
100 AGH 160-10D	160	1.00 mm	2,734	2000483
100 AGH 200-10D	200	1.00 mm	2,978	2000484
100 AGH 300-10D	300	1.00 mm	3,668	2000485
100 AGH 400-10D	400	1.00 mm	4,346	2000486

1.20 mm

Sipariş Kodu Order Code	W (mm)	T (mm)	Ağırlık (kg/m) Weight (kg/m)	Barkod Kodu Barcode Code
100 AGH 100-12D	100	1.20 mm	2,754	2000421
100 AGH 160-12D	160	1.20 mm	3,281	2000423
100 AGH 200-12D	200	1.20 mm	3,574	2000424
100 AGH 300-12D	300	1.20 mm	4,402	2000425
100 AGH 400-12D	400	1.20 mm	5,216	2000426
100 AGH 500-12D	500	1.20 mm	6,038	2000427

1.50 mm

Sipariş Kodu Order Code	W (mm)	T (mm)	Ağırlık (kg/m) Weight (kg/m)	Barkod Kodu Barcode Code
100 AGH 100-15D	100	1.50 mm	3,443	2000368
100 AGH 160-15D	160	1.50 mm	4,102	2000370
100 AGH 200-15D	200	1.50 mm	4,469	2000372
100 AGH 300-15D	300	1.50 mm	5,499	2000374
100 AGH 400-15D	400	1.50 mm	6,521	2000429
100 AGH 500-15D	500	1.50 mm	7,547	2000430
100 AGH 600-15D	600	1.50 mm	8,574	2000431

2.00 mm

Sipariş Kodu Order Code	W (mm)	T (mm)	Ağırlık (kg/m) Weight (kg/m)	Barkod Kodu Barcode Code
100 AGH 100-20D	100	2.00 mm	4,593	2000369
100 AGH 160-20D	160	2.00 mm	5,469	2000371
100 AGH 200-20D	200	2.00 mm	5,962	2000373
100 AGH 300-20D	300	2.00 mm	7,331	2000375
100 AGH 400-20D	400	2.00 mm	8,695	2000376
100 AGH 500-20D	500	2.00 mm	10,064	2000377
100 AGH 600-20D	600	2.00 mm	11,433	2000378
100 AGH 700-20D	700	2.00 mm	13,632	2000489
100 AGH 800-20D	800	2.00 mm	15,123	2000490
100 AGH 900-20D	900	2.00 mm	16,615	2000491

H = YÜKSEKLİK = HEIGHT / W = GENİŞLİK = WIDTH / T = KALINLIK = THICKNESS

100 AGH 100-10D

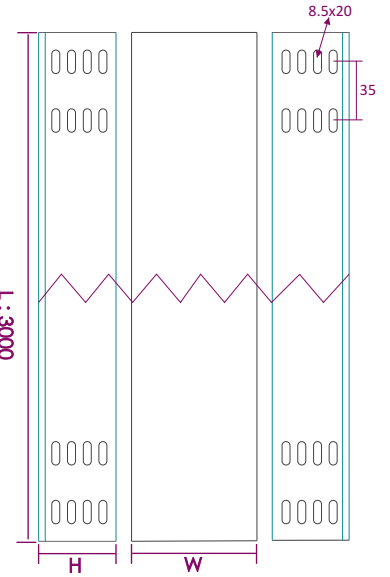
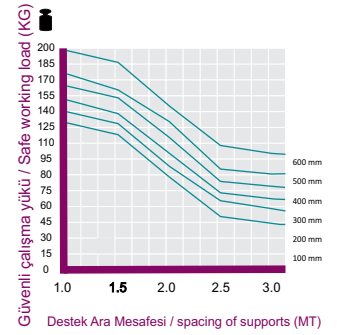

Standart uzunluk L:3000 mm
Toplu miktarlarda Özel ölçüler yapılabilir.
Standard Length L:3000 mm
Custom sizes can be made in bulk quantities.

ARTIM METAL ELEKTRİK A.Ş.

- * Farklı kalınlık ve ölçülerde üretim yapılabılır.
- * Malzeme ağırlıkları yaklaşık değerlerdir, \pm %10 değişiklik gösterebilir.
- * Malzeme kalınlık toleransı \pm %10 dur.
- * Lütfen siparişlerinizde sipariş kodu veya ürün kodu ve Kaplama şeklini belirtiniz.

- * We can produce cable trays different thickness and dimensions
- * Cable trays are shown approximately weight, they could change \pm %10 difference.
- * Cable trays thickness tolerances are shown \pm %10 .
- * Please indicate order code and coating type in your orders.

H100 AGH SERIES

AGIR HIZMET KABLO KANALI (DELIKSİZ)

HEAVY DUTY TYPE CABLE TRAYS (NON PERFORATED)

SICAK DALDIRMA (SD)

HOT DIP GALVANIZED (SD)

TS EN ISO 1461

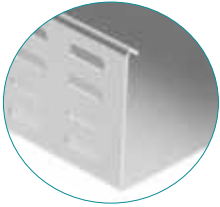

Sipariş Kodu Order Code	W (mm)	T (mm)	Ağırlık (kg/m) Weight (kg/m)	Barkod Kodu Barcode Code
100 AGH 100-10D	100	1.00 mm	2,501	2000481
100 AGH 160-10D	160	1.00 mm	2,979	2000483
100 AGH 200-10D	200	1.00 mm	3,245	2000484
100 AGH 300-10D	300	1.00 mm	3,998	2000485
100 AGH 400-10D	400	1.00 mm	4,738	2000486

Sipariş Kodu Order Code	W (mm)	T (mm)	Ağırlık (kg/m) Weight (kg/m)	Barkod Kodu Barcode Code
100 AGH 100-12D	100	1.20 mm	3,002	2000421
100 AGH 160-12D	160	1.20 mm	3,575	2000423
100 AGH 200-12D	200	1.20 mm	3,895	2000424
100 AGH 300-12D	300	1.20 mm	4,798	2000425
100 AGH 400-12D	400	1.20 mm	5,686	2000426
100 AGH 500-12D	500	1.20 mm	6,580	2000427

Sipariş Kodu Order Code	W (mm)	T (mm)	Ağırlık (kg/m) Weight (kg/m)	Barkod Kodu Barcode Code
100 AGH 100-15D	100	1.50 mm	3,787	2000368
100 AGH 160-15D	160	1.50 mm	4,471	2000370
100 AGH 200-15D	200	1.50 mm	4,920	2000372
100 AGH 300-15D	300	1.50 mm	6,052	2000374
100 AGH 400-15D	400	1.50 mm	7,107	2000429
100 AGH 500-15D	500	1.50 mm	8,304	2000430
100 AGH 600-15D	600	1.50 mm	9,432	2000431

Sipariş Kodu Order Code	W (mm)	T (mm)	Ağırlık (kg/m) Weight (kg/m)	Barkod Kodu Barcode Code
100 AGH 100-20D	100	2.00 mm	5,054	2000369
100 AGH 160-20D	160	2.00 mm	5,962	2000371
100 AGH 200-20D	200	2.00 mm	6,560	2000373
100 AGH 300-20D	300	2.00 mm	8,064	2000375
100 AGH 400-20D	400	2.00 mm	9,568	2000376
100 AGH 500-20D	500	2.00 mm	11,073	2000377
100 AGH 600-20D	600	2.00 mm	12,578	2000378
100 AGH 700-20D	700	2.00 mm	14,995	2000489
100 AGH 800-20D	800	2.00 mm	16,635	2000490
100 AGH 900-20D	900	2.00 mm	18,277	2000491

H = YÜKSEKLİK = HEIGHT / W = GENİŞLİK = WIDTH / T = KALINLIK = THICKNESS

100 AGH 100-10D

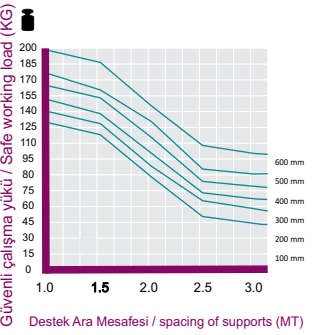

Destek Ara Mesafesi / spacing of supports (MT)

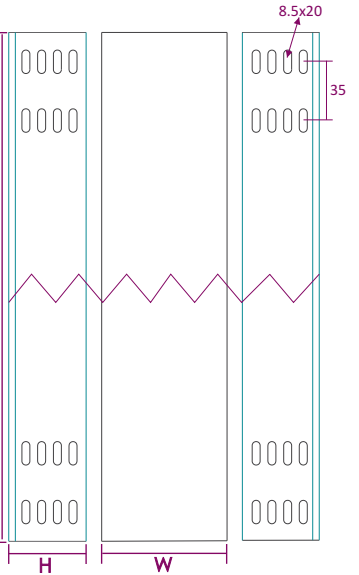

Standart uzunluk L:3000 mm
Toplu miktarlarda Özel ölçüler yapılabilir.
Standard Length L:3000 mm
Custom sizes can be made in bulk quantities.

* Farklı kalınlık ve ölçülerde üretim yapılabılır.
* Malzeme ağırlıkları yaklaşık değerlerdir, \pm %10 değişiklik gösterebilir.
* Malzeme kalınlık toleransı \pm %10 dur.
* Lütfen siparişlerinizde sipariş kodu veya ürün kodu ve Kaplama şeklini belirtiniz.

* We can produce cable trays different thickness and dimensions
* Cable trays are shown approximately weight, they could change \pm %10 difference.
* Cable trays thickness tolerances are shown \pm %10 .
* Please indicate order code and coating type in your orders.

H100 AST SERIES

STANDART TIP KABLO KANALLARI

MEDIUM DUTY CABLE TRAYS

PREGALVANİZ (PG)
PREGALVANIZED (PG)
TS EN 10346

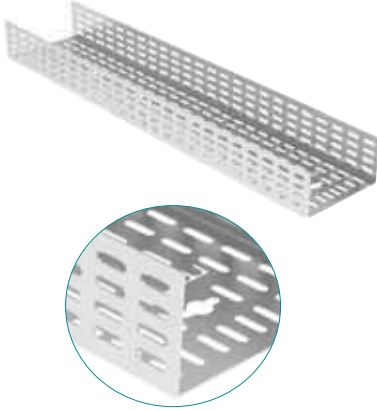

1.00 mm

Sipariş Kodu Order Code	W (mm)	T (mm)	Ağırlık (kg/m) Weight (kg/m)	Barkod Kodu Barcode Code
100 AST 100-10	100	1.00 mm	2,079	2000193
100 AST 160-10	160	1.00 mm	2,539	2000195
100 AST 200-10	200	1.00 mm	2,676	2000196

1.20 mm

Sipariş Kodu Order Code	W (mm)	T (mm)	Ağırlık (kg/m) Weight (kg/m)	Barkod Kodu Barcode Code
100 AST 100-12	100	1.20 mm	2,489	2000197
100 AST 160-12	160	1.20 mm	3,046	2000199
100 AST 200-12	200	1.20 mm	3,210	2000200
100 AST 300-12	300	1.20 mm	3,930	2000201

1.50 mm

Sipariş Kodu Order Code	W (mm)	T (mm)	Ağırlık (kg/m) Weight (kg/m)	Barkod Kodu Barcode Code
100 AST 100-15	100	1.50 mm	3,035	2000202
100 AST 160-15	160	1.50 mm	3,555	2000204
100 AST 200-15	200	1.50 mm	3,936	2000205
100 AST 300-15	300	1.50 mm	4,838	2000206
100 AST 400-15	400	1.50 mm	5,734	2000207
100 AST 500-15	500	1.50 mm	6,636	2000208
100 AST 600-15	600	1.50 mm	7,533	2000209

2.00 mm

Sipariş Kodu Order Code	W (mm)	T (mm)	Ağırlık (kg/m) Weight (kg/m)	Barkod Kodu Barcode Code
100 AST 100-20	100	2.00 mm	4,118	2000210
100 AST 160-20	160	2.00 mm	4,824	2000212
100 AST 200-20	200	2.00 mm	5,341	2000213
100 AST 300-20	300	2.00 mm	6,474	2000214
100 AST 400-20	400	2.00 mm	7,675	2000215
100 AST 500-20	500	2.00 mm	8,875	2000216
100 AST 600-20	600	2.00 mm	10,071	2000217
100 AST 700-20	700	2.00 mm	11,587	2000492
100 AST 800-20	800	2.00 mm	12,855	2000493
100 AST 900-20	900	2.00 mm	14,122	2000494

H = YÜKSEKLİK = HEIGHT / W = GENİŞLİK = WIDTH / T = KALINLIK = THICKNESS

100 AST 100 - 10

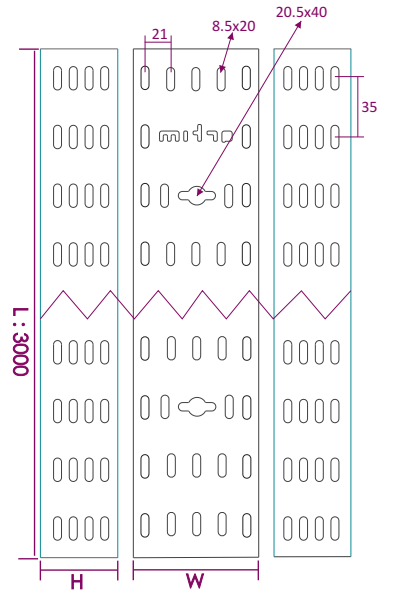
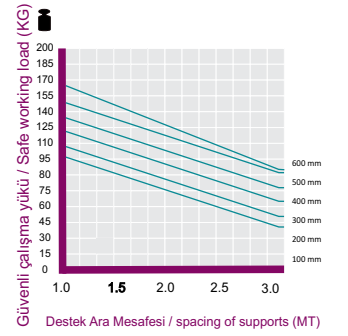

Standart uzunluk L:3000 mm
Toplu miktarlarda Özel ölçüler yapılabilir.
Standard Length L:3000 mm
Custom sizes can be made in bulk quantities.



ARTIM METAL ELEKTRİK A.Ş.

* Farklı kalınlık ve ölçülerde üretim yapılabılır.
* Malzeme ağırlıkları yaklaşık değerlerdir, ± %10 değişiklik gösterebilir.
* Malzeme kalınlık toleransı ± %10 dur.
* Lütfen siparişlerinizde sipariş kodu veya ürün kodu ve Kaplama şeklini belirtiniz.

* We can produce cable trays different thickness and dimensions
* Cable trays are shown approximately weight, they could change ± %10 difference.
* Cable trays thickness tolerances are shown ± %10 .
* Please indicate order code and coating type in your orders.

H100 AST SERIES

STANDART TIP KABLO KANALLARI

MEDIUM DUTY CABLE TRAYS

SICAK DALDIRMA (SD)
HOT DIP GALVANIZED (SD)
TS EN ISO 1461

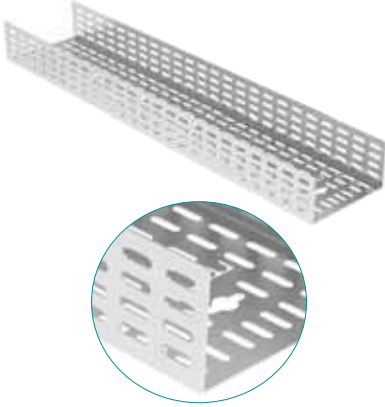

1.00 mm

Sipariş Kodu Order Code	W (mm)	T (mm)	Ağırlık (kg/m) Weight (kg/m)	Barkod Kodu Barcode Code
100 AST 100-10	100	1.00 mm	2,275	2000193
100 AST 160-10	160	1.00 mm	2,609	2000195
100 AST 200-10	200	1.00 mm	2,937	2000196

100 AST 100-10



1.20 mm

Sipariş Kodu Order Code	W (mm)	T (mm)	Ağırlık (kg/m) Weight (kg/m)	Barkod Kodu Barcode Code
100 AST 100-12	100	1.20 mm	2,731	2000197
100 AST 160-12	160	1.20 mm	3,131	2000199
100 AST 200-12	200	1.20 mm	3,525	2000200
100 AST 300-12	300	1.20 mm	4,314	2000201

1.50 mm

Sipariş Kodu Order Code	W (mm)	T (mm)	Ağırlık (kg/m) Weight (kg/m)	Barkod Kodu Barcode Code
100 AST 100-15	100	1.50 mm	3,330	2000202
100 AST 160-15	160	1.50 mm	3,653	2000204
100 AST 200-15	200	1.50 mm	4,319	2000205
100 AST 300-15	300	1.50 mm	5,309	2000206
100 AST 400-15	400	1.50 mm	6,299	2000207
100 AST 500-15	500	1.50 mm	7,289	2000208
100 AST 600-15	600	1.50 mm	8,279	2000209

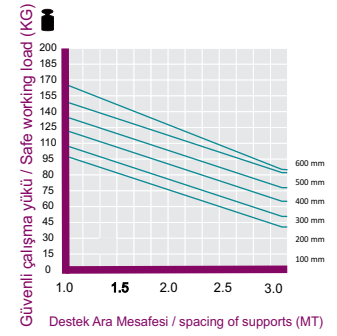

2.00 mm

Sipariş Kodu Order Code	W (mm)	T (mm)	Ağırlık (kg/m) Weight (kg/m)	Barkod Kodu Barcode Code
100 AST 100-20	100	2.00 mm	4,518	2000210
100 AST 160-20	160	2.00 mm	4,956	2000212
100 AST 200-20	200	2.00 mm	5,861	2000213
100 AST 300-20	300	2.00 mm	7,108	2000214
100 AST 400-20	400	2.00 mm	8,431	2000215
100 AST 500-20	500	2.00 mm	9,749	2000216
100 AST 600-20	600	2.00 mm	11,062	2000217
100 AST 700-20	700	2.00 mm	12,746	2000492
100 AST 800-20	800	2.00 mm	14,141	2000493
100 AST 900-20	900	2.00 mm	15,534	2000494

H = YÜKSEKLİK = HEIGHT / W = GENİŞLİK = WIDTH / T = KALINLIK = THICKNESS

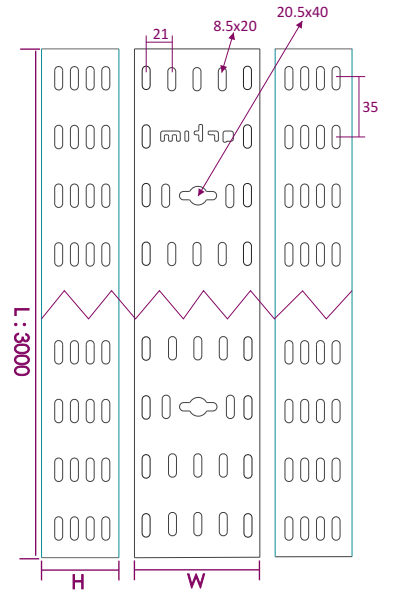

Standart uzunluk L:3000 mm
Toplu miktarlarda Özel ölçüler yapılabilir.
Standard Length L:3000 mm
Custom sizes can be made in bulk quantities.



* Farklı kalınlık ve ölçülerde üretim yapılabılır.
* Malzeme ağırlıkları yaklaşık değerlerdir, ± %10 değişiklik gösterebilir.
* Malzeme kalınlık toleransı ± %10 dur.
* Lütfen siparişlerinizde sipariş kodu veya ürün kodu ve Kaplama şeklini belirtiniz.

* We can produce cable trays different thickness and dimensions
* Cable trays are shown approximately weight, they could change ± %10 difference.
* Cable trays thickness tolerances are shown ± %10 .
* Please indicate order code and coating type in your orders.

H100 AST SERIES

STANDART TİP KABLO KANALLARI (DELİKSİZ)

MEDIUM DUTY CABLE TRAYS (NON PERFORATED)

PREGALVANİZ (PG)
PREGALVANİZED (PG)
TS EN 10346

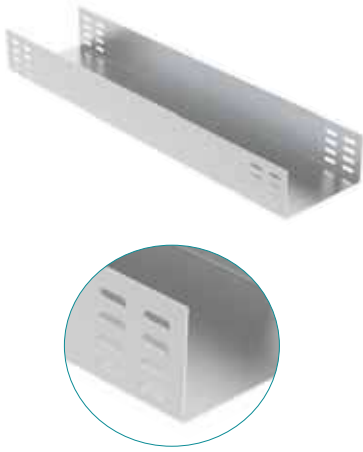

1.00 mm

Sipariş Kodu Order Code	W (mm)	T (mm)	Ağırlık (kg/m) Weight (kg/m)	Barkod Kodu Barcode Code
100 AST 100-10D	100	1.00 mm	2,391	2000193
100 AST 160-10D	160	1.00 mm	2,920	2000195
100 AST 200-10D	200	1.00 mm	3,077	2000196

1.20 mm

Sipariş Kodu Order Code	W (mm)	T (mm)	Ağırlık (kg/m) Weight (kg/m)	Barkod Kodu Barcode Code
100 AST 100-12D	100	1.20 mm	2,862	2000197
100 AST 160-12D	160	1.20 mm	3,503	2000199
100 AST 200-12D	200	1.20 mm	3,692	2000200
100 AST 300-12D	300	1.20 mm	4,520	2000201

1.50 mm

Sipariş Kodu Order Code	W (mm)	T (mm)	Ağırlık (kg/m) Weight (kg/m)	Barkod Kodu Barcode Code
100 AST 100-15D	100	1.50 mm	3,490	2000202
100 AST 160-15D	160	1.50 mm	4,088	2000204
100 AST 200-15D	200	1.50 mm	4,526	2000205
100 AST 300-15D	300	1.50 mm	5,564	2000206
100 AST 400-15D	400	1.50 mm	6,594	2000207
100 AST 500-15D	500	1.50 mm	7,631	2000208
100 AST 600-15D	600	1.50 mm	8,663	2000209

2.00 mm

Sipariş Kodu Order Code	W (mm)	T (mm)	Ağırlık (kg/m) Weight (kg/m)	Barkod Kodu Barcode Code
100 AST 100-20D	100	2.00 mm	4,736	2000210
100 AST 160-20D	160	2.00 mm	5,548	2000212
100 AST 200-20D	200	2.00 mm	6,142	2000213
100 AST 300-20D	300	2.00 mm	7,445	2000214
100 AST 400-20D	400	2.00 mm	8,826	2000215
100 AST 500-20D	500	2.00 mm	10,206	2000216
100 AST 600-20D	600	2.00 mm	11,582	2000217
100 AST 700-20D	700	2.00 mm	13,632	2000495
100 AST 800-20D	800	2.00 mm	15,124	2000496
100 AST 900-20D	900	2.00 mm	16,615	2000497

H = YÜKSEKLİK = HEIGHT / W = GENİŞLİK = WIDTH / T = KALINLIK = THICKNESS

100 AST 100-10D

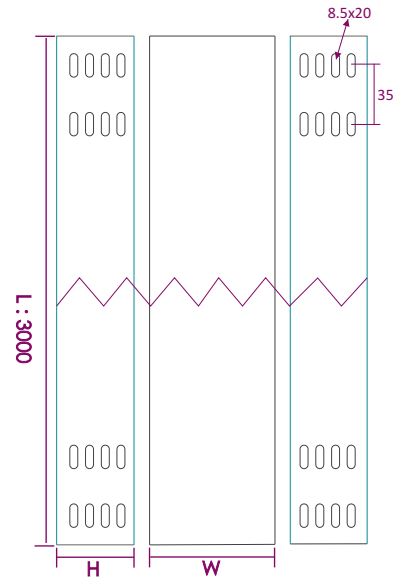
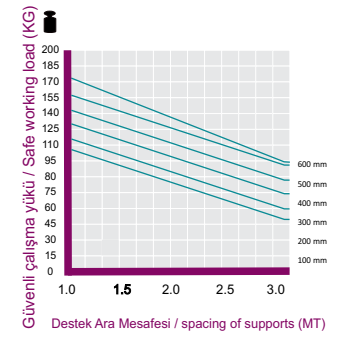

Standart uzunluk L:3000 mm
Toplu miktarlarda Özel ölçüler yapılabilir.
Standard Length L:3000 mm
Custom sizes can be made in bulk quantities.



ARTIM METAL ELEKTRİK A.Ş.

- * Farklı kalınlık ve ölçülerde üretim yapılabılır.
- * Malzeme ağırlıkları yaklaşık değerlerdir, \pm %10 değişiklik gösterebilir.
- * Malzeme kalınlık toleransı \pm %10 dur.
- * Lütfen siparişlerinizde sipariş kodu veya ürün kodu ve Kaplama şeklini belirtiniz.

- * We can produce cable trays different thickness and dimensions
- * Cable trays are shown approximately weight, they could change \pm %10 difference.
- * Cable trays thickness tolerances are shown \pm %10 .
- * Please indicate order code and coating type in your orders.

H100 AST SERIES

STANDART TIP KABLO KANALLARI (DELİKSİZ)

MEDIUM DUTY CABLE TRAYS (NON PERFORATED)

SICAK DALDIRMA (SD)
HOT DIP GALVANIZED (SD)
TS EN ISO 1461

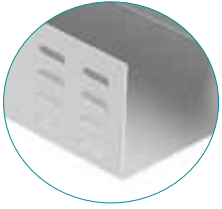

1.00 mm

Sipariş Kodu Order Code	W (mm)	T (mm)	Ağırlık (kg/m) Weight (kg/m)	Barkod Kodu Barcode Code
100 AST 100-10D	100	1.00 mm	2,616	2000193
100 AST 160-10D	160	1.00 mm	3,000	2000195
100 AST 200-10D	200	1.00 mm	3,378	2000196

1.20 mm

Sipariş Kodu Order Code	W (mm)	T (mm)	Ağırlık (kg/m) Weight (kg/m)	Barkod Kodu Barcode Code
100 AST 100-12D	100	1.20 mm	3,141	2000197
100 AST 160-12D	160	1.20 mm	3,601	2000199
100 AST 200-12D	200	1.20 mm	4,054	2000200
100 AST 300-12D	300	1.20 mm	4,961	2000201

1.50 mm

Sipariş Kodu Order Code	W (mm)	T (mm)	Ağırlık (kg/m) Weight (kg/m)	Barkod Kodu Barcode Code
100 AST 100-15D	100	1.50 mm	3,830	2000202
100 AST 160-15D	160	1.50 mm	4,201	2000204
100 AST 200-15D	200	1.50 mm	4,967	2000205
100 AST 300-15D	300	1.50 mm	6,105	2000206
100 AST 400-15D	400	1.50 mm	7,244	2000207
100 AST 500-15D	500	1.50 mm	8,382	2000208
100 AST 600-15D	600	1.50 mm	9,521	2000209

2.00 mm

Sipariş Kodu Order Code	W (mm)	T (mm)	Ağırlık (kg/m) Weight (kg/m)	Barkod Kodu Barcode Code
100 AST 100-20D	100	2.00 mm	5,196	2000210
100 AST 160-20D	160	2.00 mm	5,699	2000212
100 AST 200-20D	200	2.00 mm	6,740	2000213
100 AST 300-20D	300	2.00 mm	8,174	2000214
100 AST 400-20D	400	2.00 mm	9,696	2000215
100 AST 500-20D	500	2.00 mm	11,211	2000216
100 AST 600-20D	600	2.00 mm	12,721	2000217
100 AST 700-20D	700	2.00 mm	14,995	2000495
100 AST 800-20D	800	2.00 mm	16,636	2000496
100 AST 900-20D	900	2.00 mm	18,277	2000497

H = YÜKSEKLİK = HEIGHT / W = GENİŞLİK = WIDTH / T = KALINLIK = THICKNESS

100 AST 100-10D

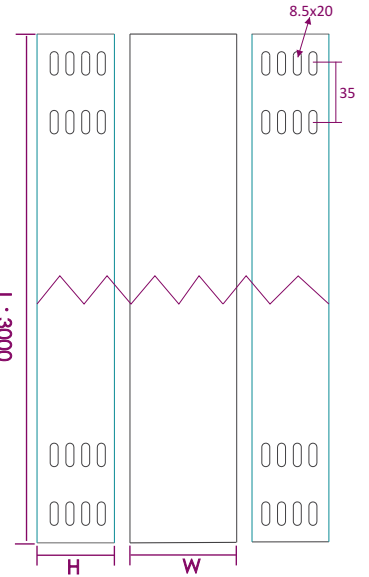
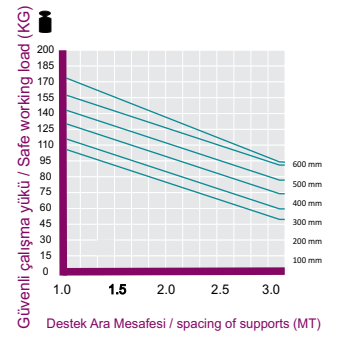

Standart uzunluk L:3000 mm
Toplu miktarlarda Özel ölçüler yapılabilir.
Standard Length L:3000 mm
Custom sizes can be made in bulk quantities.

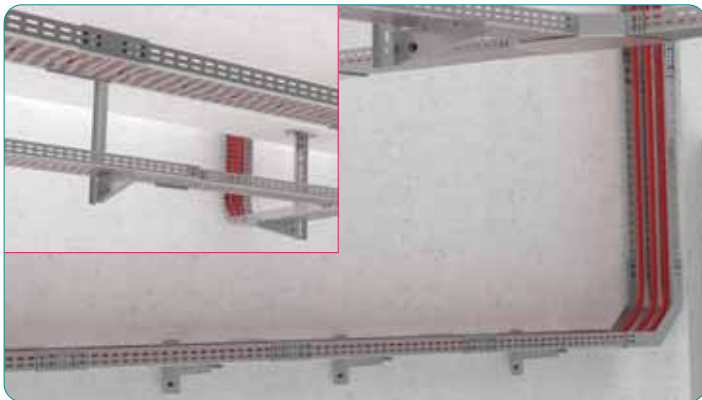

* Farklı kalınlık ve ölçülerde üretim yapılabılır.
* Malzeme ağırlıkları yaklaşık değerlerdir, ± %10 değişiklik gösterebilir.
* Malzeme kalınlık toleransı ± %10 dur.
* Lütfen siparişlerinizde sipariş kodu veya ürün kodu ve Kaplama şeklini belirtiniz.

* We can produce cable trays different thickness and dimensions
* Cable trays are shown approximately weight, they could change ± %10 difference.
* Cable trays thickness tolerances are shown ± %10 .
* Please indicate order code and coating type in your orders.

AGH SERIES

90° YATAY DÖNÜS (MODEL1)

90° BEND (MODEL1)

PREGALVANİZ (PG)
PREGALVANIZED (PG)
TS EN 10346



H40 = H50 Tek delikli
H40 = H50 One hole



H40

Sipariş Kodu Order Code	W (mm)	T (mm)	Ağırlık (kg/ad) Weight (kg/pcs)	Barkod Kodu Barcode Code
40 AGH 050Y	50	1.20 mm	0,198	2001100
40 AGH 100Y	100	1.20 mm	0,540	2001101
40 AGH 120Y	120	1.20 mm	0,684	2001102
40 AGH 160Y	160	1.20 mm	0,720	2001103
40 AGH 200Y	200	1.20 mm	1,080	2001104
40 AGH 300Y	300	1.20 mm	1,674	2001105
40 AGH 400Y	400	1.50 mm	3,362	2001106
40 AGH 500Y	500	1.50 mm	4,745	2001107
40 AGH 600Y	600	1.50 mm	6,376	2001108

H50

Sipariş Kodu Order Code	W (mm)	T (mm)	Ağırlık (kg/ad) Weight (kg/pcs)	Barkod Kodu Barcode Code
50 AGH 050Y	50	1.20 mm	0,230	2001109
50 AGH 100Y	100	1.20 mm	0,594	2001110
50 AGH 160Y	160	1.20 mm	0,785	2001111
50 AGH 200Y	200	1.20 mm	1,091	2001112
50 AGH 300Y	300	1.20 mm	1,764	2001113
50 AGH 400Y	400	1.50 mm	3,514	2001114
50 AGH 500Y	500	1.50 mm	4,921	2001115
50 AGH 600Y	600	1.50 mm	6,577	2001116

H60

Sipariş Kodu Order Code	W (mm)	T (mm)	Ağırlık (kg/ad) Weight (kg/pcs)	Barkod Kodu Barcode Code
60 AGH 100Y	100	1.20 mm	0,655	2001117
60 AGH 160Y	160	1.20 mm	0,850	2001118
60 AGH 200Y	200	1.20 mm	1,166	2001119
60 AGH 300Y	300	1.20 mm	1,868	2001120
60 AGH 400Y	400	1.50 mm	3,672	2001121
60 AGH 500Y	500	1.50 mm	5,393	2001122
60 AGH 600Y	600	1.50 mm	6,782	2001123

H100

Sipariş Kodu Order Code	W (mm)	T (mm)	Ağırlık (kg/ad) Weight (kg/pcs)	Barkod Kodu Barcode Code
100 AGH 100Y	100	1.20 mm	0,810	2001124
100 AGH 160Y	160	1.20 mm	1,087	2001125
100 AGH 200Y	200	1.20 mm	1,458	2001126
100 AGH 300Y	300	1.20 mm	2,232	2001127
100 AGH 400Y	400	1.50 mm	4,259	2001128
100 AGH 500Y	500	1.50 mm	5,789	2001129
100 AGH 600Y	600	1.50 mm	7,571	2001130

H = YÜKSEKLİK = HEIGHT / W = GENİŞLİK = WIDTH / T = KALINLIK = THICKNESS

H AGH 100 Y

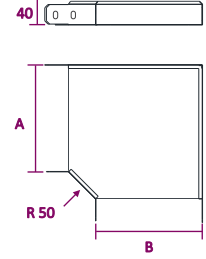

Dönüşlerde "A-B" ölçüleri esit olarak üretilmektedir. İsteğe bağlı olarak farklı ölçülerde üretim yapılır. Bends are produced same dimension for "A-B" as well as we can produce special dimensions regarding your inquiry.

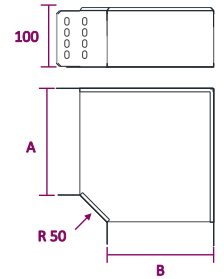
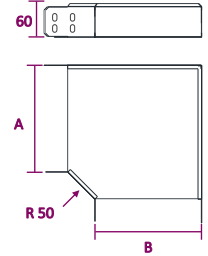

ARTIM METAL ELEKTRİK A.Ş.

- * Farklı kalınlık ve ölçülerde üretim yapılabılır.
- * Malzeme ağırlıkları yaklaşık değerlerdir, \pm %10 değişiklik gösterebilir.
- * Malzeme kalınlık toleransı \pm %10 dur.
- * Lütfen siparişlerinizde sipariş kodu veya ürün kodu ve Kaplama şeklini belirtiniz.

- * We can produce cable trays different thickness and dimensions
- * Cable trays are shown approximately weight, they could change \pm %10 difference.
- * Cable trays thickness tolerances are shown \pm %10 .
- * Please indicate order code and coating type in your orders.

AGH SERIES

90° YATAY DÖNÜS (MODEL1)

90° BEND (MODEL1)

SICAK DALDIRMA (SD)

HOT DIP GALVANİZ (HDG)

TS EN ISO 1461



H40 = H50 Tek delikli
H40 = H50 One hole



H40

Sipariş Kodu Order Code	W (mm)	T (mm)	Ağırlık (kg/ad) Weight (kg/pcs)	Barkod Kodu Barcode Code
40 AGH 050Y	50	1.50 mm	0,270	2001100
40 AGH 100Y	100	1.50 mm	0,735	2001101
40 AGH 120Y	120	1.50 mm	0,857	2001102
40 AGH 160Y	160	1.50 mm	0,980	2001103
40 AGH 200Y	200	1.50 mm	1,372	2001104
40 AGH 300Y	300	1.50 mm	2,279	2001105
40 AGH 400Y	400	2.00 mm	4,577	2001106
40 AGH 500Y	500	2.00 mm	6,458	2001107
40 AGH 600Y	600	2.00 mm	8,678	2001108

H50

Sipariş Kodu Order Code	W (mm)	T (mm)	Ağırlık (kg/ad) Weight (kg/pcs)	Barkod Kodu Barcode Code
50 AGH 050Y	50	1.50 mm	0,314	2001109
50 AGH 100Y	100	1.50 mm	0,809	2001110
50 AGH 160Y	160	1.50 mm	1,068	2001111
50 AGH 200Y	200	1.50 mm	1,485	2001112
50 AGH 300Y	300	1.50 mm	2,401	2001113
50 AGH 400Y	400	2.00 mm	4,782	2001114
50 AGH 500Y	500	2.00 mm	6,698	2001115
50 AGH 600Y	600	2.00 mm	8,952	2001116

H60

Sipariş Kodu Order Code	W (mm)	T (mm)	Ağırlık (kg/ad) Weight (kg/pcs)	Barkod Kodu Barcode Code
60 AGH 100Y	100	1.50 mm	0,892	2001117
60 AGH 160Y	160	1.50 mm	1,156	2001118
60 AGH 200Y	200	1.50 mm	1,588	2001119
60 AGH 300Y	300	1.50 mm	2,543	2001120
60 AGH 400Y	400	2.00 mm	4,998	2001121
60 AGH 500Y	500	2.00 mm	7,340	2001122
60 AGH 600Y	600	2.00 mm	9,232	2001123

H100

Sipariş Kodu Order Code	W (mm)	T (mm)	Ağırlık (kg/ad) Weight (kg/pcs)	Barkod Kodu Barcode Code
100 AGH 100Y	100	1.50 mm	1,103	2001124
100 AGH 160Y	160	1.50 mm	1,480	2001125
100 AGH 200Y	200	1.50 mm	1,985	2001126
100 AGH 300Y	300	1.50 mm	3,038	2001127
100 AGH 400Y	400	2.00 mm	5,797	2001128
100 AGH 500Y	500	2.00 mm	7,879	2001129
100 AGH 600Y	600	2.00 mm	10,305	2001130

H = YÜKSEKLİK = HEIGHT / W = GENİŞLİK = WIDTH / T = KALINLIK = THICKNESS

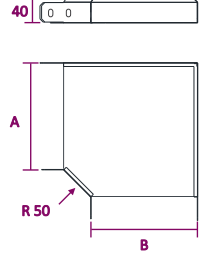
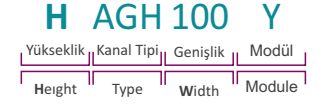

Dönüşlerde "A-B" ölçüleri esit olarak üretilmektedir. İsteğe bağlı olarak farklı ölçülerde üretim yapılır. Bends are produced same dimension for "A-B" as well as we can produce special dimensions regarding your inquiry.

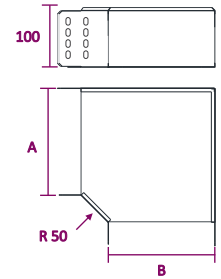
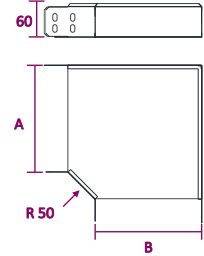

* Farklı kalınlık ve ölçülerde üretim yapılabılır.
* Malzeme ağırlıkları yaklaşık değerlerdir, ± %10 değişiklik gösterebilir.
* Malzeme kalınlık toleransı ± %10 dur.
* Lütfen siparişlerinizde sipariş kodu veya ürün kodu ve Kaplama şeklini belirtiniz.

* We can produce cable trays different thickness and dimensions
* Cable trays are shown approximately weight, they could change ± %10 difference.
* Cable trays thickness tolerances are shown ± %10 .
* Please indicate order code and coating type in your orders.

AGH SERIES

90° YATAY DÖNÜS (MODEL2)

90° BEND (MODEL2)

PREGALVANİZ (PG)
PREGALVANIZED (PG)
TS EN 10346



H40 = H50 = H60 Tek delikli
H40 = H50 = H60 One hole



Sipariş Kodu Order Code	W (mm)	T (mm)	Ağırlık (kg/ad) Weight (kg/pcs)	Barkod Kodu Barcode Code
40 AGH 050Y	50	1.20 mm	0,178	2001100
40 AGH 100Y	100	1.20 mm	0,486	2001101
40 AGH 120Y	120	1.20 mm	0,616	2001102
40 AGH 160Y	160	1.20 mm	0,648	2001103
40 AGH 200Y	200	1.20 mm	0,972	2001104
40 AGH 300Y	300	1.20 mm	1,440	2001105
40 AGH 400Y	400	1.50 mm	2,891	2001106
40 AGH 500Y	500	1.50 mm	4,081	2001107
40 AGH 600Y	600	1.50 mm	5,483	2001108

Sipariş Kodu Order Code	W (mm)	T (mm)	Ağırlık (kg/ad) Weight (kg/pcs)	Barkod Kodu Barcode Code
50 AGH 050Y	50	1.20 mm	0,207	2001109
50 AGH 100Y	100	1.20 mm	0,535	2001110
50 AGH 160Y	160	1.20 mm	0,707	2001111
50 AGH 200Y	200	1.20 mm	0,982	2001112
50 AGH 300Y	300	1.20 mm	1,517	2001113
50 AGH 400Y	400	1.50 mm	3,022	2001114
50 AGH 500Y	500	1.50 mm	4,232	2001115
50 AGH 600Y	600	1.50 mm	5,656	2001116

Sipariş Kodu Order Code	W (mm)	T (mm)	Ağırlık (kg/ad) Weight (kg/pcs)	Barkod Kodu Barcode Code
60 AGH 100Y	100	1.20 mm	0,590	2001117
60 AGH 160Y	160	1.20 mm	0,765	2001118
60 AGH 200Y	200	1.20 mm	1,049	2001119
60 AGH 300Y	300	1.20 mm	1,606	2001120
60 AGH 400Y	400	1.50 mm	3,158	2001121
60 AGH 500Y	500	1.50 mm	4,638	2001122
60 AGH 600Y	600	1.50 mm	5,833	2001123

H = YÜKSEKLİK = HEIGHT / W = GENİŞLİK = WIDTH / T = KALINLIK = THICKNESS

H AGH 100 Y

Yükseklik Kanal Tipi Genişlik Modül
Height Type Width Module

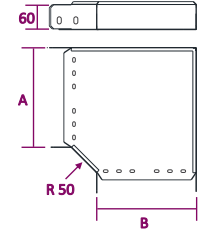
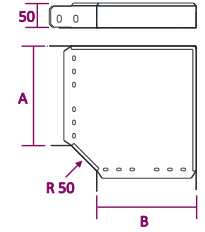
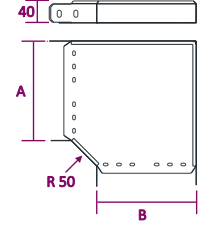

Dönüşlerde "A-B" ölçüleri eşit olarak üretilmektedir. İsteğe bağlı olarak farklı ölçülerde üretim yapılır. Bends are produced same dimension for "A-B" as well as we can produce special dimensions regarding your inquiry.

ARTIM METAL ELEKTRİK A.Ş.

- * Farklı kalınlık ve ölçülerde üretim yapılabılır.
- * Malzeme ağırlıkları yaklaşık değerlerdir, ± %10 değişiklik gösterebilir.
- * Malzeme kalınlık toleransı ± %10 dur.
- * Lütfen siparişlerinizde sipariş kodu veya ürün kodu ve Kaplama şeklini belirtiniz.

- * We can produce cable trays different thickness and dimensions
- * Cable trays are shown approximately weight, they could change ± %10 difference.
- * Cable trays thickness tolerances are shown ± %10 .
- * Please indicate order code and coating type in your orders.

AGH SERIES

90° YATAY DÖNÜŞ (MODEL2)

90° BEND (MODEL2)

SICAK DALDIRMA (SD)

HOT DIP GALVANIZED (HDG)

TS EN ISO 1461



H40 = H50 = H60 Tek delikli
H40 = H50 = H60 One hole



H40

Sipariş Kodu Order Code	W (mm)	T (mm)	Ağırlık (kg/ad) Weight (kg/pcs)	Barkod Kodu Barcode Code
40 AGH 050Y	50	1.50 mm	0,243	2001100
40 AGH 100Y	100	1.50 mm	0,662	2001101
40 AGH 120Y	120	1.20 mm	0,717	2001102
40 AGH 160Y	160	1.50 mm	0,882	2001103
40 AGH 200Y	200	1.50 mm	1,235	2001104
40 AGH 300Y	300	1.50 mm	1,960	2001105
40 AGH 400Y	400	2.00 mm	3,936	2001106
40 AGH 500Y	500	2.00 mm	5,554	2001107
40 AGH 600Y	600	2.00 mm	7,463	2001108

H50

Sipariş Kodu Order Code	W (mm)	T (mm)	Ağırlık (kg/ad) Weight (kg/pcs)	Barkod Kodu Barcode Code
50 AGH 050Y	50	1.50 mm	0,283	2001109
50 AGH 100Y	100	1.50 mm	0,728	2001110
50 AGH 160Y	160	1.50 mm	0,961	2001111
50 AGH 200Y	200	1.50 mm	1,337	2001112
50 AGH 300Y	300	1.50 mm	2,065	2001113
50 AGH 400Y	400	2.00 mm	4,113	2001114
50 AGH 500Y	500	2.00 mm	5,760	2001115
50 AGH 600Y	600	2.00 mm	7,699	2001116

H60

Sipariş Kodu Order Code	W (mm)	T (mm)	Ağırlık (kg/ad) Weight (kg/pcs)	Barkod Kodu Barcode Code
60 AGH 100Y	100	1.50 mm	0,803	2001117
60 AGH 160Y	160	1.50 mm	1,040	2001118
60 AGH 200Y	200	1.50 mm	1,429	2001119
60 AGH 300Y	300	1.50 mm	2,187	2001120
60 AGH 400Y	400	2.00 mm	4,298	2001121
60 AGH 500Y	500	2.00 mm	6,312	2001122
60 AGH 600Y	600	2.00 mm	7,940	2001123

H = YÜKSEKLİK = HEIGHT / W = GENİŞLİK = WIDTH / T = KALINLIK = THICKNESS

H AGH 100 Y

Yükseklik Kanal Tipi Genişlik Modül
Height Type Width Module

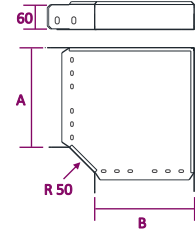
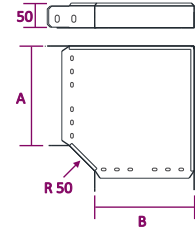
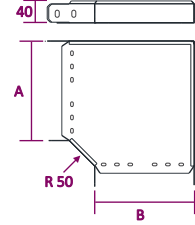

Dönüşlerde "A-B" ölçüleri esit olarak üretilmektedir. İsteğe bağlı olarak farklı ölçülerde üretim yapılır.

Bends are produced same dimension for "A-B" as well as we can produce special dimensions regarding your inquiry.

* Farklı kalınlık ve ölçülerde üretim yapılabılır.
* Malzeme ağırlıkları yaklaşık değerlerdir, ± %10 değişiklik gösterebilir.
* Malzeme kalınlık toleransı ± %10 dur.
* Lütfen siparişlerinizde sipariş kodu veya ürün kodu ve Kaplama şeklini belirtiniz.

* We can produce cable trays different thickness and dimensions
* Cable trays are shown approximately weight, they could change ± %10 difference.
* Cable trays thickness tolerances are shown ± %10 .
* Please indicate order code and coating type in your orders.

AGH SERIES

T BAGLANTI (MODEL1)

T BEND (MODEL1)

PREGALVANIZ (PG)
PREGALVANIZED (PG)
TS EN 10346



H40 = H50 Tek delikli
H40 = H50 One hole



H40

Sipariş Kodu Order Code	W (mm)	T (mm)	Ağırlık (kg/ad) Weight (kg/pcs)	Barkod Kodu Barcode Code
40 AGH 050T	50	1.20 mm	0,263	2001200
40 AGH 100T	100	1.20 mm	0,644	2001201
40 AGH 120T	120	1.20 mm	0,790	2001202
40 AGH 160T	160	1.20 mm	1,122	2001203
40 AGH 200T	200	1.20 mm	1,116	2001204
40 AGH 300T	300	1.20 mm	1,782	2001205
40 AGH 400T	400	1.50 mm	4,666	2001206
40 AGH 500T	500	1.50 mm	4,882	2001207
40 AGH 600T	600	1.50 mm	6,509	2001208

H50

Sipariş Kodu Order Code	W (mm)	T (mm)	Ağırlık (kg/ad) Weight (kg/pcs)	Barkod Kodu Barcode Code
50 AGH 050T	50	1.20 mm	0,302	2001209
50 AGH 100T	100	1.20 mm	0,716	2001210
50 AGH 160T	160	1.20 mm	0,893	2001211
50 AGH 200T	200	1.20 mm	1,202	2001212
50 AGH 300T	300	1.20 mm	1,872	2001213
50 AGH 400T	400	1.50 mm	3,629	2001214
50 AGH 500T	500	1.50 mm	5,022	2001215
50 AGH 600T	600	1.50 mm	6,664	2001216

H60

Sipariş Kodu Order Code	W (mm)	T (mm)	Ağırlık (kg/ad) Weight (kg/pcs)	Barkod Kodu Barcode Code
60 AGH 100T	100	1.20 mm	0,785	2001217
60 AGH 160T	160	1.20 mm	0,961	2001218
60 AGH 200T	200	1.20 mm	1,278	2001219
60 AGH 300T	300	1.20 mm	1,958	2001220
60 AGH 400T	400	1.50 mm	3,766	2001221
60 AGH 500T	500	1.50 mm	5,166	2001222
60 AGH 600T	600	1.50 mm	6,818	2001223

H100

Sipariş Kodu Order Code	W (mm)	T (mm)	Ağırlık (kg/ad) Weight (kg/pcs)	Barkod Kodu Barcode Code
100 AGH 100T	100	1.20 mm	1,026	2001224
100 AGH 160T	160	1.20 mm	1,202	2001225
100 AGH 200T	200	1.20 mm	1,559	2001226
100 AGH 300T	300	1.20 mm	2,275	2001227
100 AGH 400T	400	1.50 mm	4,234	2001228
100 AGH 500T	500	1.50 mm	5,688	2001229
100 AGH 600T	600	1.50 mm	7,394	2001230

H = YÜKSEKLİK = HEIGHT / W = GENİŞLİK = WIDTH / T = KALINLIK = THICKNESS

H AGH 100 T

Yükseklik Kanal Tipi Genişlik Modül
Height Type Width Module

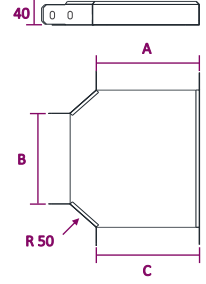

Dönüşlerde "A-B-C" ölçüleri esit olarak üretilmektedir. İsteğe bağlı olarak farklı ölçülerde üretim yapılır. Bends are produced same dimension for "A-B-C" as well as we can produce special dimensions regarding your inquiry.

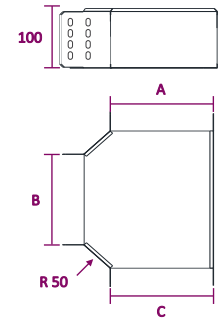
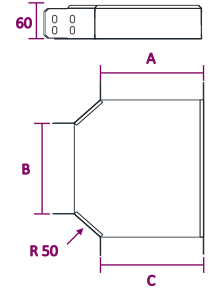

ARTIM METAL ELEKTRİK A.Ş.

* Farklı kalınlık ve ölçülerde üretim yapılabılır.
* Malzeme ağırlıkları yaklaşık değerlerdir, ± %10 değişiklik gösterebilir.
* Malzeme kalınlık toleransı ± %10 dur.
* Lütfen siparişlerinizde sipariş kodu veya ürün kodu ve Kaplama şeklini belirtiniz.

* We can produce cable trays different thickness and dimensions
* Cable trays are shown approximately weight, they could change ± %10 difference.
* Cable trays thickness tolerances are shown ± %10 .
* Please indicate order code and coating type in your orders.

AGH SERIES

T BAGLANTI (MODEL1)

T BEND (MODEL1)

SICAK DALDIRMA (SD)

HOT DIP GALVANIZED (HDG)

TS EN ISO 1461



H40 = H50 Tek delikli
H40 = H50 One hole



H40

Sipariş Kodu Order Code	W (mm)	T (mm)	Ağırlık (kg/ad) Weight (kg/pcs)	Barkod Kodu Barcode Code
40 AGH 050T	50	1.50 mm	0,358	2001200
40 AGH 100T	100	1.50 mm	0,877	2001201
40 AGH 120T	120	1.50 mm	1,000	2001202
40 AGH 160T	160	1.50 mm	1,122	2001203
40 AGH 200T	200	1.50 mm	1,519	2001204
40 AGH 300T	300	1.50 mm	2,426	2001205
40 AGH 400T	400	2.00 mm	6,350	2001206
40 AGH 500T	500	2.00 mm	6,644	2001207
40 AGH 600T	600	2.00 mm	8,859	2001208

H50

Sipariş Kodu Order Code	W (mm)	T (mm)	Ağırlık (kg/ad) Weight (kg/pcs)	Barkod Kodu Barcode Code
50 AGH 050T	50	1.50 mm	0,412	2001209
50 AGH 100T	100	1.50 mm	0,975	2001210
50 AGH 160T	160	1.50 mm	1,215	2001211
50 AGH 200T	200	1.50 mm	1,637	2001212
50 AGH 300T	300	1.50 mm	2,548	2001213
50 AGH 400T	400	2.00 mm	4,939	2001214
50 AGH 500T	500	2.00 mm	6,836	2001215
50 AGH 600T	600	2.00 mm	9,070	2001216

H60

Sipariş Kodu Order Code	W (mm)	T (mm)	Ağırlık (kg/ad) Weight (kg/pcs)	Barkod Kodu Barcode Code
60 AGH 100T	100	1.50 mm	1,068	2001217
60 AGH 160T	160	1.50 mm	1,308	2001218
60 AGH 200T	200	1.50 mm	1,740	2001219
60 AGH 300T	300	1.50 mm	2,666	2001220
60 AGH 400T	400	2.00 mm	5,125	2001221
60 AGH 500T	500	2.00 mm	7,032	2001222
60 AGH 600T	600	2.00 mm	9,281	2001223

H100

Sipariş Kodu Order Code	W (mm)	T (mm)	Ağırlık (kg/ad) Weight (kg/pcs)	Barkod Kodu Barcode Code
100 AGH 100T	100	1.50 mm	1,397	2001224
100 AGH 160T	160	1.50 mm	1,637	2001225
100 AGH 200T	200	1.50 mm	2,122	2001226
100 AGH 300T	300	1.50 mm	3,097	2001227
100 AGH 400T	400	2.00 mm	5,762	2001228
100 AGH 500T	500	2.00 mm	7,742	2001229
100 AGH 600T	600	2.00 mm	10,065	2001230

H = YÜKSEKLİK = HEIGHT / W = GENİŞLİK = WIDTH / T = KALINLIK = THICKNESS

H AGH 100 T

Yükseklik Kanal Tipi Genişlik Modül
Height Type Width Module

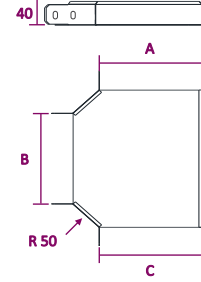

Dönüşlerde "A-B-C" ölçüleri esit olarak üretilmektedir. İsteğe bağlı olarak farklı ölçülerde üretim yapılır.
Bends are produced same dimension for "A-B-C" as well as we can produce special dimensions regarding your inquiry.

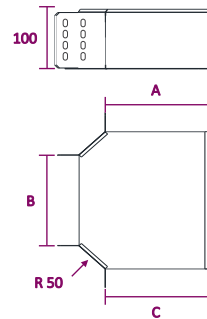
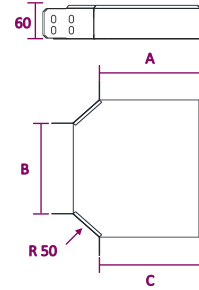

* Farklı kalınlık ve ölçülerde üretim yapılabılır.
* Malzeme ağırlıkları yaklaşık değerlerdir, ± %10 değişiklik gösterebilir.
* Malzeme kalınlık toleransı ± %10 dur.
* Lütfen siparişlerinizde sipariş kodu veya ürün kodu ve kaplama şeklini belirtiniz.

* We can produce cable trays different thickness and dimensions
* Cable trays are shown approximately weight, they could change ± %10 difference.
* Cable trays thickness tolerances are shown ± %10 .
* Please indicate order code and coating type in your orders.

AGH SERIES

T BAGLANTI (MODEL2)

T BEND (MODEL2)

PREGALVANIZ (PG)
PREGALVANIZED (PG)
TS EN 10346



H40 = H50 = H60 Tek delikli
H40 = H50 = H60 One hole



H40

Sipariş Kodu Order Code	W (mm)	T (mm)	Ağırlık (kg/ad) Weight (kg/pcs)	Barkod Kodu Barcode Code
40 AGH 050T	50	1.20 mm	0,237	2001200
40 AGH 100T	100	1.20 mm	0,580	2001201
40 AGH 120T	120	1.20 mm	0,711	2001202
40 AGH 160T	160	1.20 mm	1,010	2001203
40 AGH 200T	200	1.20 mm	1,004	2001204
40 AGH 300T	300	1.20 mm	1,604	2001205
40 AGH 400T	400	1.50 mm	4,199	2001206
40 AGH 500T	500	1.50 mm	4,394	2001207
40 AGH 600T	600	1.50 mm	5,858	2001208

H50

Sipariş Kodu Order Code	W (mm)	T (mm)	Ağırlık (kg/ad) Weight (kg/pcs)	Barkod Kodu Barcode Code
50 AGH 050T	50	1.20 mm	0,272	2001209
50 AGH 100T	100	1.20 mm	0,644	2001210
50 AGH 160T	160	1.20 mm	0,804	2001211
50 AGH 200T	200	1.20 mm	1,082	2001212
50 AGH 300T	300	1.20 mm	1,685	2001213
50 AGH 400T	400	1.50 mm	3,266	2001214
50 AGH 500T	500	1.50 mm	4,520	2001215
50 AGH 600T	600	1.50 mm	5,998	2001216

H60

Sipariş Kodu Order Code	W (mm)	T (mm)	Ağırlık (kg/ad) Weight (kg/pcs)	Barkod Kodu Barcode Code
60 AGH 100T	100	1.20 mm	0,707	2001217
60 AGH 160T	160	1.20 mm	0,865	2001218
60 AGH 200T	200	1.20 mm	1,150	2001219
60 AGH 300T	300	1.20 mm	1,762	2001220
60 AGH 400T	400	1.50 mm	3,389	2001221
60 AGH 500T	500	1.50 mm	4,649	2001222
60 AGH 600T	600	1.50 mm	6,136	2001223

H = YÜKSEKLİK = HEIGHT / W = GENİŞLİK = WIDTH / T = KALINLIK = THICKNESS

H AGH 100 T

Yükseklik Kanal Tipi Genişlik Modül
Height Type Width Module

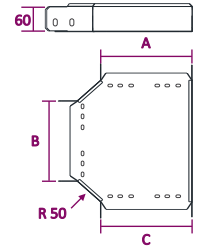
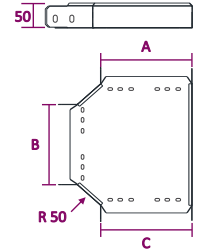
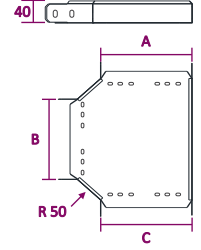

Dönüşlerde "A-B-C" ölçüleri esit olarak üretilmektedir. İsteğe bağlı olarak farklı ölçülerde üretim yapılır. Bends are produced same dimension for "A-B-C" as well as we can produce special dimensions regarding your inquiry.

ARTIM METAL ELEKTRİK A.Ş.

* Farklı kalınlık ve ölçülerde üretim yapılabılır.
* Malzeme ağırlıkları yaklaşık değerlerdir, ± %10 değişiklik gösterebilir.
* Malzeme kalınlık toleransı ± %10 dur.
* Lütfen siparişlerinizde sipariş kodu veya ürün kodu ve Kaplama şeklini belirtiniz.

* We can produce cable trays different thickness and dimensions
* Cable trays are shown approximately weight, they could change ± %10 difference.
* Cable trays thickness tolerances are shown ± %10 .
* Please indicate order code and coating type in your orders.

AGH SERIES

T BAGLANTI (MODEL2)

T BEND (MODEL2)

SICAK DALDIRMA (SD)

HOT DIP GALVANIZED (HDG)

TS EN ISO 1461



H40 = H50 = H60 Tek delikli
H40 = H50 = H60 One hole



H40

Sipariş Kodu Order Code	W (mm)	T (mm)	Ağırlık (kg/ad) Weight (kg/pcs)	Barkod Kodu Barcode Code
40 AGH 050T	50	1.50 mm	0,322	2001200
40 AGH 100T	100	1.50 mm	0,789	2001201
40 AGH 120T	120	1.50 mm	0,900	2001202
40 AGH 160T	160	1.50 mm	1,010	2001203
40 AGH 200T	200	1.50 mm	1,367	2001204
40 AGH 300T	300	1.50 mm	2,183	2001205
40 AGH 400T	400	2.00 mm	5,715	2001206
40 AGH 500T	500	2.00 mm	5,980	2001207
40 AGH 600T	600	2.00 mm	7,973	2001208

H50

Sipariş Kodu Order Code	W (mm)	T (mm)	Ağırlık (kg/ad) Weight (kg/pcs)	Barkod Kodu Barcode Code
50 AGH 050T	50	1.50 mm	0,371	2001209
50 AGH 100T	100	1.50 mm	0,878	2001210
50 AGH 160T	160	1.50 mm	1,094	2001211
50 AGH 200T	200	1.50 mm	1,473	2001212
50 AGH 300T	300	1.50 mm	2,293	2001213
50 AGH 400T	400	2.00 mm	4,445	2001214
50 AGH 500T	500	2.00 mm	6,152	2001215
50 AGH 600T	600	2.00 mm	8,163	2001216

H60

Sipariş Kodu Order Code	W (mm)	T (mm)	Ağırlık (kg/ad) Weight (kg/pcs)	Barkod Kodu Barcode Code
60 AGH 100T	100	1.50 mm	0,961	2001217
60 AGH 160T	160	1.50 mm	1,177	2001218
60 AGH 200T	200	1.50 mm	1,566	2001219
60 AGH 300T	300	1.50 mm	2,399	2001220
60 AGH 400T	400	2.00 mm	4,613	2001221
60 AGH 500T	500	2.00 mm	6,329	2001222
60 AGH 600T	600	2.00 mm	8,353	2001223

H = YÜKSEKLİK = HEIGHT / W = GENİŞLİK = WIDTH / T = KALINLIK = THICKNESS

H AGH 100 T

Yükseklik Kanal Tipi Genişlik Modül
Height Type Width Module

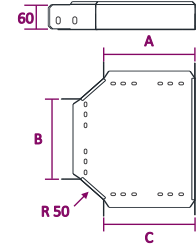
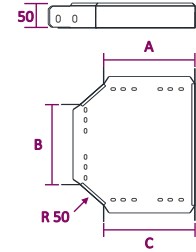
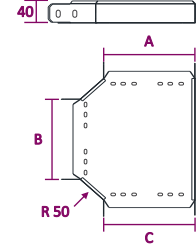

Dönüşlerde "A-B-C" ölçüleri esit olarak üretilmektedir. İsteğe bağlı olarak farklı ölçülerde üretim yapılır. Bends are produced same dimension for "A-B-C" as well as we can produce special dimensions regarding your inquiry.

* Farklı kalınlık ve ölçülerde üretim yapılabılır.
* Malzeme ağırlıkları yaklaşık değerlerdir, ± %10 değişiklik gösterebilir.
* Malzeme kalınlık toleransı ± %10 dur.
* Lütfen siparişlerinizde sipariş kodu veya ürün kodu ve Kaplama şeklini belirtiniz.

* We can produce cable trays different thickness and dimensions
* Cable trays are shown approximately weight, they could change ± %10 difference.
* Cable trays thickness tolerances are shown ± %10 .
* Please indicate order code and coating type in your orders.

AGH SERIES

DÖRTLÜ BAGLANTI (MODEL1)

FOUR WAY CROSSING (MODEL1)

PREGALVANİZ (PG)
PREGALVANİZED (PG)
TS EN 10346



H40 = H50 Tek delikli
H40 = H50 One hole



H40

Sipariş Kodu Order Code	W (mm)	T (mm)	Ağırlık (kg/ad) Weight (kg/pcs)	Barkod Kodu Barcode Code
40 AGH 050D	50	1.20 mm	0,302	2001300
40 AGH 100D	100	1.20 mm	0,752	2001301
40 AGH 120D	120	1.20 mm	0,903	2001302
40 AGH 160D	160	1.20 mm	0,922	2001303
40 AGH 200D	200	1.20 mm	1,224	2001304
40 AGH 300D	300	1.20 mm	1,886	2001305
40 AGH 400D	400	1.50 mm	3,640	2001306
40 AGH 500D	500	1.50 mm	5,011	2001307
40 AGH 600D	600	1.50 mm	6,638	2001308

H50

Sipariş Kodu Order Code	W (mm)	T (mm)	Ağırlık (kg/ad) Weight (kg/pcs)	Barkod Kodu Barcode Code
50 AGH 050D	50	1.20 mm	0,342	2001309
50 AGH 100D	100	1.20 mm	0,828	2001310
50 AGH 160D	160	1.20 mm	0,909	2001311
50 AGH 200D	200	1.20 mm	1,303	2001312
50 AGH 300D	300	1.20 mm	1,962	2001313
50 AGH 400D	400	1.50 mm	3,737	2001314
50 AGH 500D	500	1.50 mm	5,119	2001315
50 AGH 600D	600	1.50 mm	6,739	2001316

H60

Sipariş Kodu Order Code	W (mm)	T (mm)	Ağırlık (kg/ad) Weight (kg/pcs)	Barkod Kodu Barcode Code
60 AGH 100D	100	1.20 mm	0,900	2001317
60 AGH 160D	160	1.20 mm	1,058	2001318
60 AGH 200D	200	1.20 mm	1,379	2001319
60 AGH 300D	300	1.20 mm	2,034	2001320
60 AGH 400D	400	1.50 mm	3,841	2001321
60 AGH 500D	500	1.50 mm	5,220	2001322
60 AGH 600D	600	1.50 mm	6,840	2001323

H100

Sipariş Kodu Order Code	W (mm)	T (mm)	Ağırlık (kg/ad) Weight (kg/pcs)	Barkod Kodu Barcode Code
100 AGH 100D	100	1.20 mm	1,163	2001324
100 AGH 160D	160	1.20 mm	1,296	2001325
100 AGH 200D	200	1.20 mm	1,634	2001326
100 AGH 300D	300	1.20 mm	2,297	2001327
100 AGH 400D	400	1.50 mm	4,183	2001328
100 AGH 500D	500	1.50 mm	5,558	2001329
100 AGH 600D	600	1.50 mm	7,186	2001330

H = YÜKSEKLİK = HEIGHT / W = GENİŞLİK = WIDTH / T = KALINLIK = THICKNESS

H AGH 100 D

Yükseklik Kanal Tipi Genişlik Modül
Height Type Width Module

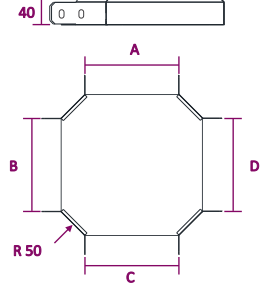

Dönüşlerde "A-B-C-D" ölçüleri esit olarak üretilmektedir. İsteğe bağlı olarak farklı ölçülerde üretim yapılır. Bends are produced same dimension for "A-B-C-D" as well as we can produce special dimensions regarding your inquiry.

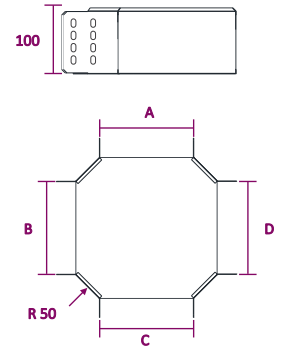
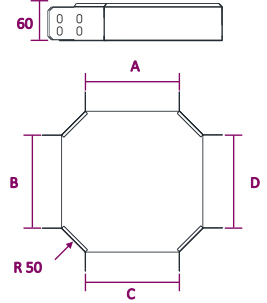

ARTIM METAL ELEKTRİK A.Ş.

* Farklı kalınlık ve ölçülerde üretim yapılabılır.
* Malzeme ağırlıkları yaklaşık değerlerdir, ± %10 değişiklik gösterebilir.
* Malzeme kalınlık toleransı ± %10 dur.
* Lütfen siparişlerinizde sipariş kodu veya ürün kodu ve Kaplama şeklini belirtiniz.

* We can produce cable trays different thickness and dimensions
* Cable trays are shown approximately weight, they could change ± %10 difference.
* Cable trays thickness tolerances are shown ± %10 .
* Please indicate order code and coating type in your orders.

AGH SERIES

DÖRTLÜ BAGLANTI (MODEL1)

FOUR WAY CROSSING (MODEL1)

SICAK DALDIRMA (SD)

HOT DIP GALVANIZED (SD)

TS EN ISO 1461



H40 = H50 Tek delikli
H40 = H50 One hole



H40

Sipariş Kodu Order Code	W (mm)	T (mm)	Ağırlık (kg/ad) Weight (kg/pcs)	Barkod Kodu Barcode Code
40 AGH 050D	50	1.50 mm	0,412	2001300
40 AGH 100D	100	1.50 mm	1,024	2001301
40 AGH 120D	120	1.50 mm	1,139	2001302
40 AGH 160D	160	1.50 mm	1,254	2001303
40 AGH 200D	200	1.50 mm	1,666	2001304
40 AGH 300D	300	1.50 mm	2,568	2001305
40 AGH 400D	400	2.00 mm	4,954	2001306
40 AGH 500D	500	2.00 mm	6,821	2001307
40 AGH 600D	600	2.00 mm	9,036	2001308

H50

Sipariş Kodu Order Code	W (mm)	T (mm)	Ağırlık (kg/ad) Weight (kg/pcs)	Barkod Kodu Barcode Code
50 AGH 050D	50	1.50 mm	0,466	2001309
50 AGH 100D	100	1.50 mm	1,127	2001310
50 AGH 160D	160	1.50 mm	1,348	2001311
50 AGH 200D	200	1.50 mm	1,774	2001312
50 AGH 300D	300	1.50 mm	2,671	2001313
50 AGH 400D	400	2.00 mm	5,086	2001314
50 AGH 500D	500	2.00 mm	6,968	2001315
50 AGH 600D	600	2.00 mm	9,173	2001316

H60

Sipariş Kodu Order Code	W (mm)	T (mm)	Ağırlık (kg/ad) Weight (kg/pcs)	Barkod Kodu Barcode Code
60 AGH 100D	100	1.50 mm	1,225	2001317
60 AGH 160D	160	1.50 mm	1,441	2001318
60 AGH 200D	200	1.50 mm	1,877	2001319
60 AGH 300D	300	1.50 mm	2,769	2001320
60 AGH 400D	400	2.00 mm	5,228	2001321
60 AGH 500D	500	2.00 mm	7,105	2001322
60 AGH 600D	600	2.00 mm	9,310	2001323

H100

Sipariş Kodu Order Code	W (mm)	T (mm)	Ağırlık (kg/ad) Weight (kg/pcs)	Barkod Kodu Barcode Code
100 AGH 100D	100	1.50 mm	1,583	2001324
100 AGH 160D	160	1.50 mm	1,764	2001325
100 AGH 200D	200	1.50 mm	2,225	2001326
100 AGH 300D	300	1.50 mm	3,126	2001327
100 AGH 400D	400	2.00 mm	5,694	2001328
100 AGH 500D	500	2.00 mm	7,566	2001329
100 AGH 600D	600	2.00 mm	9,780	2001330

H = YÜKSEKLİK = HEIGHT / W = GENİŞLİK = WIDTH / T = KALINLIK = THICKNESS

H AGH 100 D

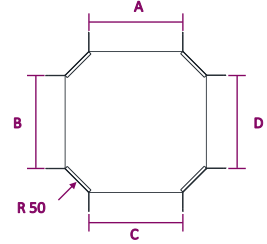

Dönüşlerde "A-B-C-D" ölçüleri esit olarak üretilmektedir. İsteğe bağlı olarak farklı ölçülerde üretim yapılır. Bends are produced same dimension for "A-B-C-D" as well as we can produce special dimensions regarding your inquiry.

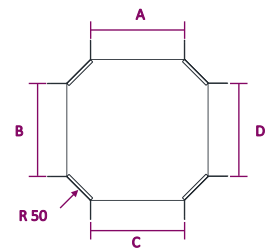
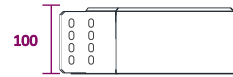
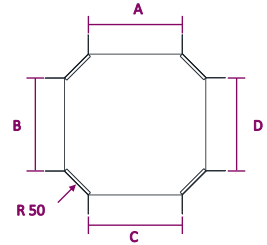

* Farklı kalınlık ve ölçülerde üretim yapılabılır.
* Malzeme ağırlıkları yaklaşık değerlerdir, ± %10 değişiklik gösterebilir.
* Malzeme kalınlık toleransı ± %10 dur.
* Lütfen siparişlerinizde sipariş kodu veya ürün kodu ve kaplama şeklini belirtiniz.

* We can produce cable trays different thickness and dimensions
* Cable trays are shown approximately weight, they could change ± %10 difference.
* Cable trays thickness tolerances are shown ± %10 .
* Please indicate order code and coating type in your orders.

AGH SERIES

DÖRTLÜ BAGLANTI (MODEL2)

FOUR WAY CROSSING (MODEL2)

PREGALVANIZ (PG)
PREGALVANIZED (PG)
TS EN 10346



H40 = H50 = H60 Tek delikli
H40 = H50 = H60 One hole



H40				
Sipariş Kodu Order Code	W (mm)	T (mm)	Ağırlık (kg/ad) Weight (kg/pcs)	Barkod Kodu Barcode Code
40 AGH 050D	50	1.20 mm	0,272	2001300
40 AGH 100D	100	1.20 mm	0,677	2001301
40 AGH 120D	120	1.20 mm	0,813	2001302
40 AGH 160D	160	1.20 mm	0,830	2001303
40 AGH 200D	200	1.20 mm	1,102	2001304
40 AGH 300D	300	1.20 mm	1,697	2001305
40 AGH 400D	400	1.50 mm	3,276	2001306
40 AGH 500D	500	1.50 mm	4,510	2001307
40 AGH 600D	600	1.50 mm	5,974	2001308

H50				
Sipariş Kodu Order Code	W (mm)	T (mm)	Ağırlık (kg/ad) Weight (kg/pcs)	Barkod Kodu Barcode Code
50 AGH 050D	50	1.20 mm	0,308	2001309
50 AGH 100D	100	1.20 mm	0,745	2001310
50 AGH 160D	160	1.20 mm	0,818	2001311
50 AGH 200D	200	1.20 mm	1,173	2001312
50 AGH 300D	300	1.20 mm	1,766	2001313
50 AGH 400D	400	1.50 mm	3,363	2001314
50 AGH 500D	500	1.50 mm	4,607	2001315
50 AGH 600D	600	1.50 mm	6,065	2001316

H60				
Sipariş Kodu Order Code	W (mm)	T (mm)	Ağırlık (kg/ad) Weight (kg/pcs)	Barkod Kodu Barcode Code
60 AGH 100D	100	1.20 mm	0,810	2001317
60 AGH 160D	160	1.20 mm	0,952	2001318
60 AGH 200D	200	1.20 mm	1,241	2001319
60 AGH 300D	300	1.20 mm	1,831	2001320
60 AGH 400D	400	1.50 mm	3,457	2001321
60 AGH 500D	500	1.50 mm	4,698	2001322
60 AGH 600D	600	1.50 mm	6,156	2001323

H = YÜKSEKLİK = HEIGHT / W = GENİŞLİK = WIDTH / T = KALINLIK = THICKNESS

H AGH 100 D
Yükseklik Kanal Tipi Genişlik Modül
Height Type Width Module

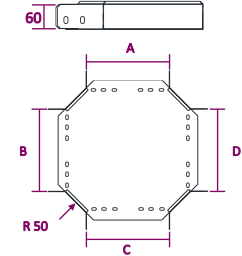
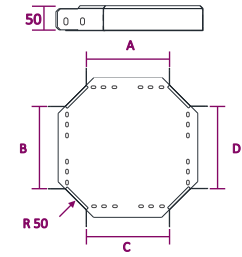
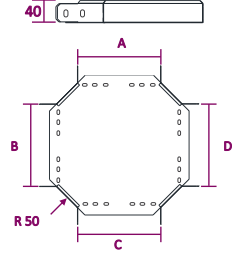

Dönüşlerde "A-B-C-D" ölçüleri esit olarak üretilmektedir. İsteğe bağlı olarak farklı ölçülerde üretim yapılır. Bends are produced same dimension for "A-B-C-D" as well as we can produce special dimensions regarding your inquiry.

ARTIM METAL ELEKTRİK A.Ş.

* Farklı kalınlık ve ölçülerde üretim yapılabılır.
* Malzeme ağırlıkları yaklaşık değerlerdir, ± %10 değişiklik gösterebilir.
* Malzeme kalınlık toleransı ± %10 dur.
* Lütfen siparişlerinizde sipariş kodu veya ürün kodu ve Kaplama şeklini belirtiniz.

* We can produce cable trays different thickness and dimensions
* Cable trays are shown approximately weight, they could change ± %10 difference.
* Cable trays thickness tolerances are shown ± %10 .
* Please indicate order code and coating type in your orders.

AGH SERIES

DÖRTLÜ BAGLANTI (MODEL2)

FOUR WAY CROSSING (MODEL2)

SICAK DALDIRMA (SD)

HOT DIP GALVANIZED (SD)

TS EN ISO 1461



Sipariş Kodu Order Code	W (mm)	T (mm)	Ağırlık (kg/ad) Weight (kg/pcs)	Barkod Kodu Barcode Code
40 AGH 050D	50	1.50 mm	0,371	2001300
40 AGH 100D	100	1.50 mm	0,922	2001301
40 AGH 120D	120	1.50 mm	1,025	2001302
40 AGH 160D	160	1.50 mm	1,129	2001303
40 AGH 200D	200	1.50 mm	1,499	2001304
40 AGH 300D	300	1.50 mm	2,311	2001305
40 AGH 400D	400	2.00 mm	4,459	2001306
40 AGH 500D	500	2.00 mm	6,139	2001307
40 AGH 600D	600	2.00 mm	8,132	2001308

H40

H AGH 100 D

Yükseklik Kanal Tipi Genişlik Modül
Height Type Width Module

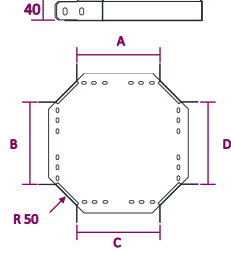

H40 = H50 = H60 Tek delikli
H40 = H50 = H60 One hole

Sipariş Kodu Order Code	W (mm)	T (mm)	Ağırlık (kg/ad) Weight (kg/pcs)	Barkod Kodu Barcode Code
50 AGH 050D	50	1.50 mm	0,419	2001309
50 AGH 100D	100	1.50 mm	1,014	2001310
50 AGH 160D	160	1.50 mm	1,213	2001311
50 AGH 200D	200	1.50 mm	1,597	2001312
50 AGH 300D	300	1.50 mm	2,404	2001313
50 AGH 400D	400	2.00 mm	4,577	2001314
50 AGH 500D	500	2.00 mm	6,271	2001315
50 AGH 600D	600	2.00 mm	8,256	2001316

H50

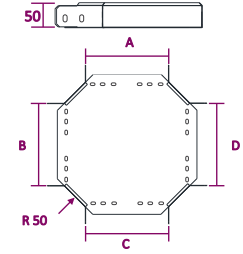

Sipariş Kodu Order Code	W (mm)	T (mm)	Ağırlık (kg/ad) Weight (kg/pcs)	Barkod Kodu Barcode Code
60 AGH 100D	100	1.50 mm	1,103	2001317
60 AGH 160D	160	1.50 mm	1,297	2001318
60 AGH 200D	200	1.50 mm	1,689	2001319
60 AGH 300D	300	1.50 mm	2,492	2001320
60 AGH 400D	400	2.00 mm	4,705	2001321
60 AGH 500D	500	2.00 mm	6,395	2001322
60 AGH 600D	600	2.00 mm	8,379	2001323

H60

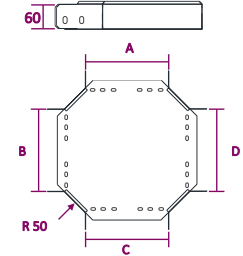

H = YÜKSEKLİK = HEIGHT / W = GENİŞLİK = WIDTH / T = KALINLIK = THICKNESS

Dönüşlerde "A-B-C-D" ölçüleri esit olarak üretilmektedir. İsteğe bağlı olarak farklı ölçülerde üretim yapılır. Bends are produced same dimension for "A-B-C-D" as well as we can produce special dimensions regarding your inquiry.

* Farklı kalınlık ve ölçülerde üretim yapılabılır.
* Malzeme ağırlıkları yaklaşık değerlerdir, ± %10 değişiklik gösterebilir.
* Malzeme kalınlık toleransı ± %10 dur.
* Lütfen siparişlerinizde sipariş kodu veya ürün kodu ve Kaplama şeklini belirtiniz.

* We can produce cable trays different thickness and dimensions
* Cable trays are shown approximately weight, they could change ± %10 difference.
* Cable trays thickness tolerances are shown ± %10 .
* Please indicate order code and coating type in your orders.

AGH SERIES

90° YATAY DÖNÜS R300 (MODEL1)

90° BEND R300 (MODEL1)

PREGALVANIZ (PG)
PREGALVANIZED (PG)
TS EN 10346



H40 = H50 Tek delikli
H40 = H50 One hole



H40

Sipariş Kodu Order Code	W (mm)	T (mm)	Ağırlık (kg/ad) Weight (kg/pcs)	Barkod Kodu Barcode Code
40 AGH 050Y	50	1.20 mm	0,214	2001100
40 AGH 100Y	100	1.20 mm	0,583	2001101
40 AGH 120Y	120	1.20 mm	0,739	2001102
40 AGH 160Y	160	1.20 mm	0,778	2001103
40 AGH 200Y	200	1.20 mm	1,166	2001104
40 AGH 300Y	300	1.20 mm	1,808	2001105
40 AGH 400Y	400	1.50 mm	3,631	2001106
40 AGH 500Y	500	1.50 mm	5,125	2001107
40 AGH 600Y	600	1.50 mm	6,886	2001108

H50

Sipariş Kodu Order Code	W (mm)	T (mm)	Ağırlık (kg/ad) Weight (kg/pcs)	Barkod Kodu Barcode Code
50 AGH 050Y	50	1.20 mm	0,248	2001109
50 AGH 100Y	100	1.20 mm	0,642	2001110
50 AGH 160Y	160	1.20 mm	0,848	2001111
50 AGH 200Y	200	1.20 mm	1,178	2001112
50 AGH 300Y	300	1.20 mm	1,905	2001113
50 AGH 400Y	400	1.50 mm	3,795	2001114
50 AGH 500Y	500	1.50 mm	5,315	2001115
50 AGH 600Y	600	1.50 mm	7,103	2001116

H60

Sipariş Kodu Order Code	W (mm)	T (mm)	Ağırlık (kg/ad) Weight (kg/pcs)	Barkod Kodu Barcode Code
60 AGH 100Y	100	1.20 mm	0,707	2001117
60 AGH 160Y	160	1.20 mm	0,918	2001118
60 AGH 200Y	200	1.20 mm	1,259	2001119
60 AGH 300Y	300	1.20 mm	2,017	2001120
60 AGH 400Y	400	1.50 mm	3,966	2001121
60 AGH 500Y	500	1.50 mm	5,824	2001122
60 AGH 600Y	600	1.50 mm	7,325	2001123

H100

Sipariş Kodu Order Code	W (mm)	T (mm)	Ağırlık (kg/ad) Weight (kg/pcs)	Barkod Kodu Barcode Code
100 AGH 100Y	100	1.20 mm	0,875	2001124
100 AGH 160Y	160	1.20 mm	1,174	2001125
100 AGH 200Y	200	1.20 mm	1,575	2001126
100 AGH 300Y	300	1.20 mm	2,411	2001127
100 AGH 400Y	400	1.50 mm	4,600	2001128
100 AGH 500Y	500	1.50 mm	6,252	2001129
100 AGH 600Y	600	1.50 mm	8,177	2001130

H = YÜKSEKLİK = HEIGHT / W = GENİŞLİK = WIDTH / T = KALINLIK = THICKNESS

H AGH 100 Y

Yükseklik Kanal Tipi Genişlik Modül
Height Type Width Module

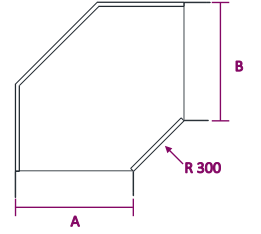
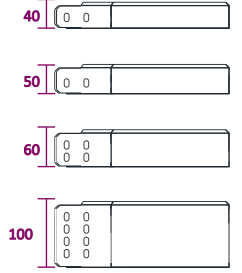

Dönüşlerde "A-B" ölçüleri esit olarak üretilmektedir. İsteğe bağlı olarak farklı ölçülerde üretim yapılır. Bends are produced same dimension for "A-B" as well as we can produce special dimensions regarding your inquiry.

ARTIM METAL ELEKTRİK A.Ş.

* Farklı kalınlık ve ölçülerde üretim yapılabılır.
* Malzeme ağırlıkları yaklaşık değerlerdir, \pm %10 değişiklik gösterebilir.
* Malzeme kalınlık toleransı \pm %10 dur.
* Lütfen siparişlerinizde sipariş kodu veya ürün kodu ve Kaplama şeklini belirtiniz.

* We can produce cable trays different thickness and dimensions
* Cable trays are shown approximately weight, they could change \pm %10 difference.
* Cable trays thickness tolerances are shown \pm %10 .
* Please indicate order code and coating type in your orders.

AGH SERIES

90° YATAY DÖNÜS R300 (MODEL1)

90° BEND R300 (MODEL1)

SICAK DALDIRMA (SD)

HOT DIP GALVANIZED (SD)

TS EN ISO 1461



H40 = H50 Tek delikli
H40 = H50 One hole

H40

Sipariş Kodu Order Code	W (mm)	T (mm)	Ağırlık (kg/ad) Weight (kg/pcs)	Barkod Kodu Barcode Code
40 AGH 050Y	50	1.50 mm	0,292	2001100
40 AGH 100Y	100	1.50 mm	0,794	2001101
40 AGH 120Y	120	1.50 mm	0,926	2001102
40 AGH 160Y	160	1.50 mm	1,058	2001103
40 AGH 200Y	200	1.50 mm	1,482	2001104
40 AGH 300Y	300	1.50 mm	2,461	2001105
40 AGH 400Y	400	2.00 mm	4,943	2001106
40 AGH 500Y	500	2.00 mm	6,975	2001107
40 AGH 600Y	600	2.00 mm	9,372	2001108

H50

Sipariş Kodu Order Code	W (mm)	T (mm)	Ağırlık (kg/ad) Weight (kg/pcs)	Barkod Kodu Barcode Code
50 AGH 050Y	50	1.50 mm	0,339	2001109
50 AGH 100Y	100	1.50 mm	0,874	2001110
50 AGH 160Y	160	1.50 mm	1,153	2001111
50 AGH 200Y	200	1.50 mm	1,604	2001112
50 AGH 300Y	300	1.50 mm	2,593	2001113
50 AGH 400Y	400	2.00 mm	5,165	2001114
50 AGH 500Y	500	2.00 mm	7,234	2001115
50 AGH 600Y	600	2.00 mm	9,668	2001116

H60

Sipariş Kodu Order Code	W (mm)	T (mm)	Ağırlık (kg/ad) Weight (kg/pcs)	Barkod Kodu Barcode Code
60 AGH 100Y	100	1.50 mm	0,963	2001117
60 AGH 160Y	160	1.50 mm	1,248	2001118
60 AGH 200Y	200	1.50 mm	1,715	2001119
60 AGH 300Y	300	1.50 mm	2,746	2001120
60 AGH 400Y	400	2.00 mm	5,398	2001121
60 AGH 500Y	500	2.00 mm	7,927	2001122
60 AGH 600Y	600	2.00 mm	9,971	2001123

H100

Sipariş Kodu Order Code	W (mm)	T (mm)	Ağırlık (kg/ad) Weight (kg/pcs)	Barkod Kodu Barcode Code
100 AGH 100Y	100	1.50 mm	1,191	2001124
100 AGH 160Y	160	1.50 mm	1,598	2001125
100 AGH 200Y	200	1.50 mm	2,144	2001126
100 AGH 300Y	300	1.50 mm	3,281	2001127
100 AGH 400Y	400	2.00 mm	6,261	2001128
100 AGH 500Y	500	2.00 mm	8,509	2001129
100 AGH 600Y	600	2.00 mm	11,129	2001130

H = YÜKSEKLİK = HEIGHT / W = GENİŞLİK = WIDTH / T = KALINLIK = THICKNESS

H AGH 100 Y

Yükseklik Kanal Tipi Genişlik Modül
Height Type Width Module

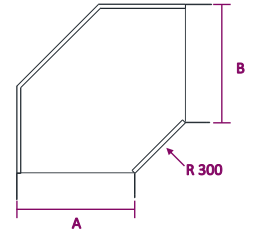
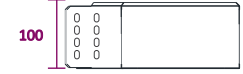

Dönüşlerde "A-B" ölçüleri eşit olarak üretilmektedir. İsteğe bağlı olarak farklı ölçülerde üretim yapılır.
Bends are produced same dimension for "A-B" as well as we can produce special dimensions regarding your inquiry.



* Farklı kalınlık ve ölçülerde üretim yapılabilmektedir.
* Malzeme ağırlıkları yaklaşık değerlerdir, \pm %10 değişiklik gösterebilir.
* Malzeme kalınlık toleransı \pm %10 dur.
* Lütfen siparişlerinizde sipariş kodu veya ürün kodu ve kaplama şeklini belirtiniz.

* We can produce cable trays different thickness and dimensions
* Cable trays are shown approximately weight, they could change \pm %10 difference.
* Cable trays thickness tolerances are shown \pm %10 .
* Please indicate order code and coating type in your orders.

AGH SERIES

90° YATAY DÖNÜŞ R450 (MODEL1)

90° BEND R450 (MODEL1)

PREGALVANIZ (PG)
PREGALVANIZED (PG)
TS EN 10346



H40 = H50 Tek delikli
H40 = H50 One hole



H40

Sipariş Kodu Order Code	W (mm)	T (mm)	Ağırlık (kg/ad) Weight (kg/pcs)	Barkod Kodu Barcode Code
40 AGH 050Y	50	1.20 mm	0,257	2001100
40 AGH 100Y	100	1.20 mm	0,700	2001101
40 AGH 120Y	120	1.20 mm	0,886	2001102
40 AGH 160Y	160	1.20 mm	0,933	2001103
40 AGH 200Y	200	1.20 mm	1,400	2001104
40 AGH 300Y	300	1.20 mm	2,170	2001105
40 AGH 400Y	400	1.50 mm	4,357	2001106
40 AGH 500Y	500	1.50 mm	6,150	2001107
40 AGH 600Y	600	1.50 mm	8,263	2001108

H50

Sipariş Kodu Order Code	W (mm)	T (mm)	Ağırlık (kg/ad) Weight (kg/pcs)	Barkod Kodu Barcode Code
50 AGH 050Y	50	1.20 mm	0,298	2001109
50 AGH 100Y	100	1.20 mm	0,770	2001110
50 AGH 160Y	160	1.20 mm	1,017	2001111
50 AGH 200Y	200	1.20 mm	1,414	2001112
50 AGH 300Y	300	1.20 mm	2,286	2001113
50 AGH 400Y	400	1.50 mm	4,554	2001114
50 AGH 500Y	500	1.50 mm	6,378	2001115
50 AGH 600Y	600	1.50 mm	8,524	2001116

H60

Sipariş Kodu Order Code	W (mm)	T (mm)	Ağırlık (kg/ad) Weight (kg/pcs)	Barkod Kodu Barcode Code
60 AGH 100Y	100	1.20 mm	0,849	2001117
60 AGH 160Y	160	1.20 mm	1,102	2001118
60 AGH 200Y	200	1.20 mm	1,511	2001119
60 AGH 300Y	300	1.20 mm	2,421	2001120
60 AGH 400Y	400	1.50 mm	4,759	2001121
60 AGH 500Y	500	1.50 mm	6,989	2001122
60 AGH 600Y	600	1.50 mm	8,789	2001123

H100

Sipariş Kodu Order Code	W (mm)	T (mm)	Ağırlık (kg/ad) Weight (kg/pcs)	Barkod Kodu Barcode Code
100 AGH 100Y	100	1.20 mm	1,050	2001124
100 AGH 160Y	160	1.20 mm	1,409	2001125
100 AGH 200Y	200	1.20 mm	1,890	2001126
100 AGH 300Y	300	1.20 mm	2,893	2001127
100 AGH 400Y	400	1.50 mm	5,520	2001128
100 AGH 500Y	500	1.50 mm	7,503	2001129
100 AGH 600Y	600	1.50 mm	9,812	2001130

H = YÜKSEKLİK = HEIGHT / W = GENİŞLİK = WIDTH / T = KALINLIK = THICKNESS

H AGH 100 Y

Yükseklik Kanal Tipi Genişlik Modül
Height Type Width Module

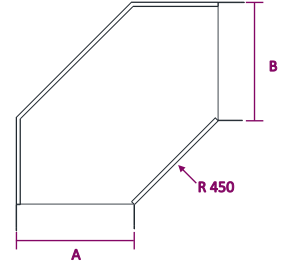
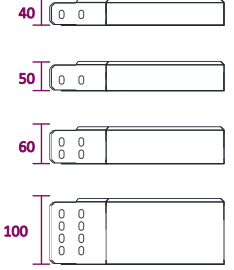

Dönüşlerde "A-B" ölçüleri eşit olarak üretilmektedir. İsteğe bağlı olarak farklı ölçülerde üretim yapılır. Bends are produced same dimension for "A-B" as well as we can produce special dimensions regarding your inquiry.

ARTIM METAL ELEKTRİK A.Ş.

* Farklı kalınlık ve ölçülerde üretim yapılabılır.
* Malzeme ağırlıkları yaklaşık değerlerdir, ± %10 değişiklik gösterebilir.
* Malzeme kalınlık toleransı ± %10 dur.
* Lütfen siparişlerinizde sipariş kodu veya ürün kodu ve Kaplama şeklini belirtiniz.

* We can produce cable trays different thickness and dimensions
* Cable trays are shown approximately weight, they could change ± %10 difference.
* Cable trays thickness tolerances are shown ± %10 .
* Please indicate order code and coating type in your orders.

AGH SERIES

90° YATAY DÖNÜŞ R450 (MODEL1)

90° BEND R450 (MODEL1)

SICAK DALDIRMA (SD)

HOT DIP GALVANIZED (SD)

TS EN ISO 1461



H40 = H50 Tek delikli
H40 = H50 One hole



H40

Sipariş Kodu Order Code	W (mm)	T (mm)	Ağırlık (kg/ad) Weight (kg/pcs)	Barkod Kodu Barcode Code
40 AGH 050Y	50	1.50 mm	0,350	2001100
40 AGH 100Y	100	1.50 mm	0,953	2001101
40 AGH 120Y	120	1.50 mm	1,111	2001102
40 AGH 160Y	160	1.50 mm	1,270	2001103
40 AGH 200Y	200	1.50 mm	1,778	2001104
40 AGH 300Y	300	1.50 mm	2,954	2001105
40 AGH 400Y	400	2.00 mm	5,932	2001106
40 AGH 500Y	500	2.00 mm	8,370	2001107
40 AGH 600Y	600	2.00 mm	11,247	2001108

H50

Sipariş Kodu Order Code	W (mm)	T (mm)	Ağırlık (kg/ad) Weight (kg/pcs)	Barkod Kodu Barcode Code
50 AGH 050Y	50	1.50 mm	0,407	2001109
50 AGH 100Y	100	1.50 mm	1,048	2001110
50 AGH 160Y	160	1.50 mm	1,384	2001111
50 AGH 200Y	200	1.50 mm	1,925	2001112
50 AGH 300Y	300	1.50 mm	3,112	2001113
50 AGH 400Y	400	2.00 mm	6,197	2001114
50 AGH 500Y	500	2.00 mm	8,681	2001115
50 AGH 600Y	600	2.00 mm	11,602	2001116

H60

Sipariş Kodu Order Code	W (mm)	T (mm)	Ağırlık (kg/ad) Weight (kg/pcs)	Barkod Kodu Barcode Code
60 AGH 100Y	100	1.50 mm	1,156	2001117
60 AGH 160Y	160	1.50 mm	1,498	2001118
60 AGH 200Y	200	1.50 mm	2,058	2001119
60 AGH 300Y	300	1.50 mm	3,296	2001120
60 AGH 400Y	400	2.00 mm	6,477	2001121
60 AGH 500Y	500	2.00 mm	9,513	2001122
60 AGH 600Y	600	2.00 mm	11,965	2001123

H100

Sipariş Kodu Order Code	W (mm)	T (mm)	Ağırlık (kg/ad) Weight (kg/pcs)	Barkod Kodu Barcode Code
100 AGH 100Y	100	1.50 mm	1,429	2001124
100 AGH 160Y	160	1.50 mm	1,918	2001125
100 AGH 200Y	200	1.50 mm	2,573	2001126
100 AGH 300Y	300	1.50 mm	3,937	2001127
100 AGH 400Y	400	2.00 mm	7,513	2001128
100 AGH 500Y	500	2.00 mm	10,211	2001129
100 AGH 600Y	600	2.00 mm	13,355	2001130

H = YÜKSEKLİK = HEIGHT / W = GENİŞLİK = WIDTH / T = KALINLIK = THICKNESS

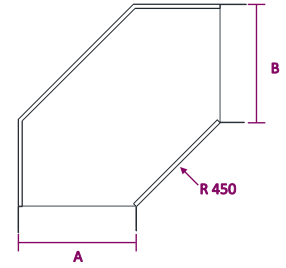
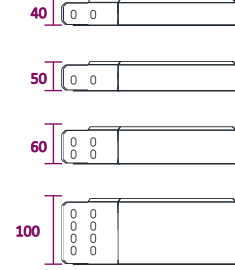
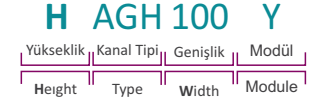

Dönüşlerde "A-B" ölçüleri esit olarak üretilmektedir. İsteğe bağlı olarak farklı ölçülerde üretim yapılır. Bends are produced same dimension for "A-B" as well as we can produce special dimensions regarding your inquiry.

* Farklı kalınlık ve ölçülerde üretim yapılabılır.
* Malzeme ağırlıkları yaklaşık değerlerdir, ± %10 değişiklik gösterebilir.
* Malzeme kalınlık toleransı ± %10 dur.
* Lütfen siparişlerinizde sipariş kodu veya ürün kodu ve Kaplama şeklini belirtiniz.

* We can produce cable trays different thickness and dimensions
* Cable trays are shown approximately weight, they could change ± %10 difference.
* Cable trays thickness tolerances are shown ± %10 .
* Please indicate order code and coating type in your orders.

AGH SERIES

90° YATAY DÖNÜŞ R600 (MODEL1)

90° BEND R600 (MODEL1)

PREGALVANIZ (PG)
PREGALVANIZED (PG)
TS EN 10346



H40 = H50 Tek delikli
H40 = H50 One hole



H40

Sipariş Kodu Order Code	W (mm)	T (mm)	Ağırlık (kg/ad) Weight (kg/pcs)	Barkod Kodu Barcode Code
40 AGH 050Y	50	1.20 mm	0,298	2001100
40 AGH 100Y	100	1.20 mm	0,812	2001101
40 AGH 120Y	120	1.20 mm	1,028	2001102
40 AGH 160Y	160	1.20 mm	1,082	2001103
40 AGH 200Y	200	1.20 mm	1,624	2001104
40 AGH 300Y	300	1.20 mm	2,517	2001105
40 AGH 400Y	400	1.50 mm	5,054	2001106
40 AGH 500Y	500	1.50 mm	7,133	2001107
40 AGH 600Y	600	1.50 mm	9,585	2001108

H50

Sipariş Kodu Order Code	W (mm)	T (mm)	Ağırlık (kg/ad) Weight (kg/pcs)	Barkod Kodu Barcode Code
50 AGH 050Y	50	1.20 mm	0,346	2001109
50 AGH 100Y	100	1.20 mm	0,893	2001110
50 AGH 160Y	160	1.20 mm	1,180	2001111
50 AGH 200Y	200	1.20 mm	1,640	2001112
50 AGH 300Y	300	1.20 mm	2,652	2001113
50 AGH 400Y	400	1.50 mm	5,283	2001114
50 AGH 500Y	500	1.50 mm	7,398	2001115
50 AGH 600Y	600	1.50 mm	9,888	2001116

H60

Sipariş Kodu Order Code	W (mm)	T (mm)	Ağırlık (kg/ad) Weight (kg/pcs)	Barkod Kodu Barcode Code
60 AGH 100Y	100	1.20 mm	0,985	2001117
60 AGH 160Y	160	1.20 mm	1,278	2001118
60 AGH 200Y	200	1.20 mm	1,753	2001119
60 AGH 300Y	300	1.20 mm	2,808	2001120
60 AGH 400Y	400	1.50 mm	5,520	2001121
60 AGH 500Y	500	1.50 mm	8,108	2001122
60 AGH 600Y	600	1.50 mm	10,196	2001123

H100

Sipariş Kodu Order Code	W (mm)	T (mm)	Ağırlık (kg/ad) Weight (kg/pcs)	Barkod Kodu Barcode Code
100 AGH 100Y	100	1.20 mm	1,218	2001124
100 AGH 160Y	160	1.20 mm	1,634	2001125
100 AGH 200Y	200	1.20 mm	2,192	2001126
100 AGH 300Y	300	1.20 mm	3,355	2001127
100 AGH 400Y	400	1.50 mm	6,403	2001128
100 AGH 500Y	500	1.50 mm	8,703	2001129
100 AGH 600Y	600	1.50 mm	11,382	2001130

H = YÜKSEKLİK = HEIGHT / W = GENİŞLİK = WIDTH / T = KALINLIK = THICKNESS

H AGH 100 Y

Yükseklik Kanal Tipi Genişlik Modül
Height Type Width Module

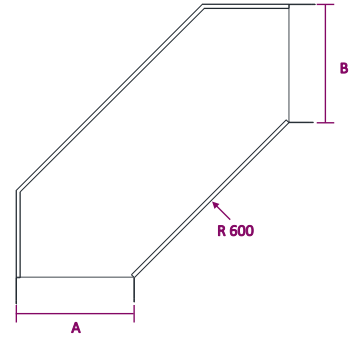
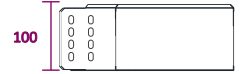

Dönüşlerde "A-B" ölçüleri esit olarak üretilmektedir. İsteğe bağlı olarak farklı ölçülerde üretim yapılır. Bends are produced same dimension for "A-B" as well as we can produce special dimensions regarding your inquiry.

ARTIM METAL ELEKTRİK A.Ş.

* Farklı kalınlık ve ölçülerde üretim yapılabılır.
* Malzeme ağırlıkları yaklaşık değerlerdir, ± %10 değişiklik gösterebilir.
* Malzeme kalınlık toleransı ± %10 dur.
* Lütfen siparişlerinizde sipariş kodu veya ürün kodu ve Kaplama şeklini belirtiniz.

* We can produce cable trays different thickness and dimensions
* Cable trays are shown approximately weight, they could change ± %10 difference.
* Cable trays thickness tolerances are shown ± %10 .
* Please indicate order code and coating type in your orders.

AGH SERIES

90° YATAY DÖNÜS R600 (MODEL1)

90° BEND R600 (MODEL1)

SICAK DALDIRMA (SD)

HOT DIP GALVANIZED (SD)

TS EN ISO 1461



H40 = H50 Tek delikli

H40 = H50 One hole



H40

Sipariş Kodu Order Code	W (mm)	T (mm)	Ağırlık (kg/ad) Weight (kg/pcs)	Barkod Kodu Barcode Code
40 AGH 050Y	50	1.50 mm	0,406	2001100
40 AGH 100Y	100	1.50 mm	1,105	2001101
40 AGH 120Y	120	1.50 mm	1,288	2001102
40 AGH 160Y	160	1.50 mm	1,473	2001103
40 AGH 200Y	200	1.50 mm	2,063	2001104
40 AGH 300Y	300	1.50 mm	3,426	2001105
40 AGH 400Y	400	2.00 mm	6,881	2001106
40 AGH 500Y	500	2.00 mm	9,709	2001107
40 AGH 600Y	600	2.00 mm	13,046	2001108

H50

Sipariş Kodu Order Code	W (mm)	T (mm)	Ağırlık (kg/ad) Weight (kg/pcs)	Barkod Kodu Barcode Code
50 AGH 050Y	50	1.50 mm	0,472	2001109
50 AGH 100Y	100	1.50 mm	1,216	2001110
50 AGH 160Y	160	1.50 mm	1,606	2001111
50 AGH 200Y	200	1.50 mm	2,232	2001112
50 AGH 300Y	300	1.50 mm	3,610	2001113
50 AGH 400Y	400	2.00 mm	7,189	2001114
50 AGH 500Y	500	2.00 mm	10,070	2001115
50 AGH 600Y	600	2.00 mm	13,458	2001116

H60

Sipariş Kodu Order Code	W (mm)	T (mm)	Ağırlık (kg/ad) Weight (kg/pcs)	Barkod Kodu Barcode Code
60 AGH 100Y	100	1.50 mm	1,341	2001117
60 AGH 160Y	160	1.50 mm	1,738	2001118
60 AGH 200Y	200	1.50 mm	2,387	2001119
60 AGH 300Y	300	1.50 mm	3,823	2001120
60 AGH 400Y	400	2.00 mm	7,514	2001121
60 AGH 500Y	500	2.00 mm	11,035	2001122
60 AGH 600Y	600	2.00 mm	13,879	2001123

H100

Sipariş Kodu Order Code	W (mm)	T (mm)	Ağırlık (kg/ad) Weight (kg/pcs)	Barkod Kodu Barcode Code
100 AGH 100Y	100	1.50 mm	1,658	2001124
100 AGH 160Y	160	1.50 mm	2,225	2001125
100 AGH 200Y	200	1.50 mm	2,984	2001126
100 AGH 300Y	300	1.50 mm	4,567	2001127
100 AGH 400Y	400	2.00 mm	8,715	2001128
100 AGH 500Y	500	2.00 mm	11,845	2001129
100 AGH 600Y	600	2.00 mm	15,492	2001130

H = YÜKSEKLİK = HEIGHT / W = GENİŞLİK = WIDTH / T = KALINLIK = THICKNESS

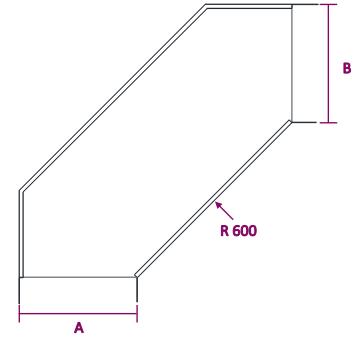
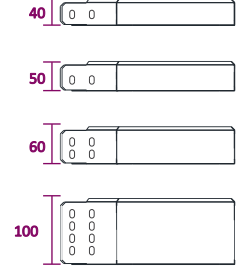
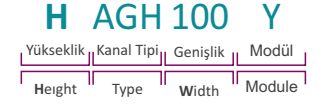

Dönüşlerde "A-B" ölçüleri eşit olarak üretilmektedir. İsteğe bağlı olarak farklı ölçülerde üretim yapılır.

Bends are produced same dimension for "A-B" as well as we can produce special dimensions regarding your inquiry.

* Farklı kalınlık ve ölçülerde üretim yapılabılır.
* Malzeme ağırlıkları yaklaşık değerlerdir, ± %10 değişiklik gösterebilir.
* Malzeme kalınlık toleransı ± %10 dur.
* Lütfen siparişinizde sipariş kodu veya ürün kodu ve Kaplama şeklini belirtiniz.

* We can produce cable trays different thickness and dimensions
* Cable trays are shown approximately weight, they could change ± %10 difference.
* Cable trays thickness tolerances are shown ± %10 .
* Please indicate order code and coating type in your orders.

AGH SERIES

T BAGLANTI R300 (MODEL1)

T BEND R300 (MODEL1)

PREGALVANIZ (PG)
PREGALVANIZED (PG)
TS EN 10346



H40 = H50 Tek delikli
H40 = H50 One hole

H40

Sipariş Kodu Order Code	W (mm)	T (mm)	Ağırlık (kg/ad) Weight (kg/pcs)	Barkod Kodu Barcode Code
40 AGH 050T	50	1.20 mm	0,284	2001200
40 AGH 100T	100	1.20 mm	0,696	2001201
40 AGH 120T	120	1.20 mm	0,853	2001202
40 AGH 160T	160	1.20 mm	1,212	2001203
40 AGH 200T	200	1.20 mm	1,205	2001204
40 AGH 300T	300	1.20 mm	1,925	2001205
40 AGH 400T	400	1.50 mm	5,039	2001206
40 AGH 500T	500	1.50 mm	5,273	2001207
40 AGH 600T	600	1.50 mm	7,030	2001208

H50

Sipariş Kodu Order Code	W (mm)	T (mm)	Ağırlık (kg/ad) Weight (kg/pcs)	Barkod Kodu Barcode Code
50 AGH 050T	50	1.20 mm	0,326	2001209
50 AGH 100T	100	1.20 mm	0,773	2001210
50 AGH 160T	160	1.20 mm	0,964	2001211
50 AGH 200T	200	1.20 mm	1,298	2001212
50 AGH 300T	300	1.20 mm	2,022	2001213
50 AGH 400T	400	1.50 mm	3,919	2001214
50 AGH 500T	500	1.50 mm	5,424	2001215
50 AGH 600T	600	1.50 mm	7,197	2001216

H60

Sipariş Kodu Order Code	W (mm)	T (mm)	Ağırlık (kg/ad) Weight (kg/pcs)	Barkod Kodu Barcode Code
60 AGH 100T	100	1.20 mm	0,848	2001217
60 AGH 160T	160	1.20 mm	1,038	2001218
60 AGH 200T	200	1.20 mm	1,380	2001219
60 AGH 300T	300	1.20 mm	2,115	2001220
60 AGH 400T	400	1.50 mm	4,067	2001221
60 AGH 500T	500	1.50 mm	5,579	2001222
60 AGH 600T	600	1.50 mm	7,363	2001223

H100

Sipariş Kodu Order Code	W (mm)	T (mm)	Ağırlık (kg/ad) Weight (kg/pcs)	Barkod Kodu Barcode Code
100 AGH 100T	100	1.20 mm	1,108	2001224
100 AGH 160T	160	1.20 mm	1,298	2001225
100 AGH 200T	200	1.20 mm	1,684	2001226
100 AGH 300T	300	1.20 mm	2,457	2001227
100 AGH 400T	400	1.50 mm	4,573	2001228
100 AGH 500T	500	1.50 mm	6,143	2001229
100 AGH 600T	600	1.50 mm	7,986	2001230

H = YÜKSEKLİK = HEIGHT / W = GENİŞLİK = WIDTH / T = KALINLIK = THICKNESS

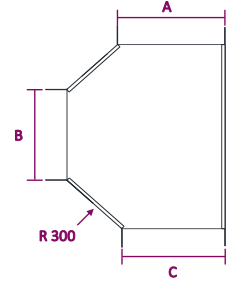
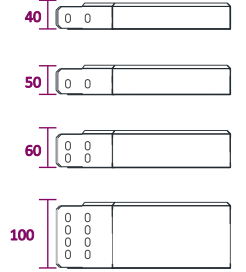

Dönüşlerde "A-B-C" ölçüleri esit olarak üretilmektedir. İsteğe bağlı olarak farklı ölçülerde üretim yapılır. Bends are produced same dimension for "A-B-C" as well as we can produce special dimensions regarding your inquiry.

ARTIM METAL ELEKTRİK A.Ş.

* Farklı kalınlık ve ölçülerde üretim yapılabılır.
* Malzeme ağırlıkları yaklaşık değerlerdir, ± %10 değişiklik gösterebilir.
* Malzeme kalınlık toleransı ± %10 dur.
* Lütfen siparişlerinizde sipariş kodu veya ürün kodu ve Kaplama şeklini belirtiniz.

* We can produce cable trays different thickness and dimensions
* Cable trays are shown approximately weight, they could change ± %10 difference.
* Cable trays thickness tolerances are shown ± %10 .
* Please indicate order code and coating type in your orders.

AGH SERIES

T BAGLANTI R300 (MODEL1)

T BEND R300 (MODEL1)

SICAK DALDIRMA (SD)

HOT DIP GALVANIZED (HDG)

TS EN ISO 1461



H40 = H50 Tek delikli
H40 = H50 One hole



H40

Sipariş Kodu Order Code	W (mm)	T (mm)	Ağırlık (kg/ad) Weight (kg/pcs)	Barkod Kodu Barcode Code
40 AGH 050T	50	1.50 mm	0,387	2001200
40 AGH 100T	100	1.50 mm	0,947	2001201
40 AGH 120T	120	1.50 mm	1,080	2001202
40 AGH 160T	160	1.50 mm	1,212	2001203
40 AGH 200T	200	1.50 mm	1,641	2001204
40 AGH 300T	300	1.50 mm	2,620	2001205
40 AGH 400T	400	2.00 mm	6,858	2001206
40 AGH 500T	500	2.00 mm	7,176	2001207
40 AGH 600T	600	2.00 mm	9,568	2001208

H50

Sipariş Kodu Order Code	W (mm)	T (mm)	Ağırlık (kg/ad) Weight (kg/pcs)	Barkod Kodu Barcode Code
50 AGH 050T	50	1.50 mm	0,445	2001209
50 AGH 100T	100	1.50 mm	1,053	2001210
50 AGH 160T	160	1.50 mm	1,312	2001211
50 AGH 200T	200	1.50 mm	1,768	2001212
50 AGH 300T	300	1.50 mm	2,752	2001213
50 AGH 400T	400	2.00 mm	5,334	2001214
50 AGH 500T	500	2.00 mm	7,383	2001215
50 AGH 600T	600	2.00 mm	9,796	2001216

H60

Sipariş Kodu Order Code	W (mm)	T (mm)	Ağırlık (kg/ad) Weight (kg/pcs)	Barkod Kodu Barcode Code
60 AGH 100T	100	1.50 mm	1,153	2001217
60 AGH 160T	160	1.50 mm	1,413	2001218
60 AGH 200T	200	1.50 mm	1,879	2001219
60 AGH 300T	300	1.50 mm	2,879	2001220
60 AGH 400T	400	2.00 mm	5,535	2001221
60 AGH 500T	500	2.00 mm	7,595	2001222
60 AGH 600T	600	2.00 mm	10,023	2001223

H100

Sipariş Kodu Order Code	W (mm)	T (mm)	Ağırlık (kg/ad) Weight (kg/pcs)	Barkod Kodu Barcode Code
100 AGH 100T	100	1.50 mm	1,509	2001224
100 AGH 160T	160	1.50 mm	1,768	2001225
100 AGH 200T	200	1.50 mm	2,292	2001226
100 AGH 300T	300	1.50 mm	3,345	2001227
100 AGH 400T	400	2.00 mm	6,223	2001228
100 AGH 500T	500	2.00 mm	8,361	2001229
100 AGH 600T	600	2.00 mm	10,870	2001230

H = YÜKSEKLİK = HEIGHT / W = GENİŞLİK = WIDTH / T = KALINLIK = THICKNESS

H AGH 100 T

Yükseklik Kanal Tipi Genişlik Modül
Height Type Width Module

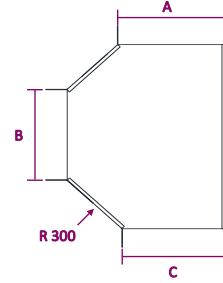
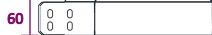
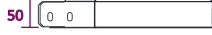

Dönüşlerde "A-B-C" ölçüleri esit olarak üretilmektedir. İsteğe bağlı olarak farklı ölçülerde üretim yapılır. Bends are produced same dimension for "A-B-C" as well as we can produce special dimensions regarding your inquiry.

* Farklı kalınlık ve ölçülerde üretim yapılabılır.
* Malzeme ağırlıkları yaklaşık değerlerdir, ± %10 değişiklik gösterebilir.
* Malzeme kalınlık toleransı ± %10 dur.
* Lütfen siparişlerinizde sipariş kodu veya ürün kodu ve Kaplama şeklini belirtiniz.

* We can produce cable trays different thickness and dimensions
* Cable trays are shown approximately weight, they could change ± %10 difference.
* Cable trays thickness tolerances are shown ± %10 .
* Please indicate order code and coating type in your orders.

AGH SERIES

T BAGLANTI R450 (MODEL1)

T BEND R450 (MODEL1)

PREGALVANIZ (PG)
PREGALVANIZED (PG)
TS EN 10346



H40 = H50 Tek delikli
H40 = H50 One hole



H40

Sipariş Kodu Order Code	W (mm)	T (mm)	Ağırlık (kg/ad) Weight (kg/pcs)	Barkod Kodu Barcode Code
40 AGH 050T	50	1.20 mm	0,341	2001200
40 AGH 100T	100	1.20 mm	0,835	2001201
40 AGH 120T	120	1.20 mm	1,024	2001202
40 AGH 160T	160	1.20 mm	1,454	2001203
40 AGH 200T	200	1.20 mm	1,446	2001204
40 AGH 300T	300	1.20 mm	2,309	2001205
40 AGH 400T	400	1.50 mm	6,047	2001206
40 AGH 500T	500	1.50 mm	6,327	2001207
40 AGH 600T	600	1.50 mm	8,436	2001208

H50

Sipariş Kodu Order Code	W (mm)	T (mm)	Ağırlık (kg/ad) Weight (kg/pcs)	Barkod Kodu Barcode Code
50 AGH 050T	50	1.20 mm	0,391	2001209
50 AGH 100T	100	1.20 mm	0,928	2001210
50 AGH 160T	160	1.20 mm	1,157	2001211
50 AGH 200T	200	1.20 mm	1,558	2001212
50 AGH 300T	300	1.20 mm	2,426	2001213
50 AGH 400T	400	1.50 mm	4,703	2001214
50 AGH 500T	500	1.50 mm	6,509	2001215
50 AGH 600T	600	1.50 mm	8,637	2001216

H60

Sipariş Kodu Order Code	W (mm)	T (mm)	Ağırlık (kg/ad) Weight (kg/pcs)	Barkod Kodu Barcode Code
60 AGH 100T	100	1.20 mm	1,017	2001217
60 AGH 160T	160	1.20 mm	1,245	2001218
60 AGH 200T	200	1.20 mm	1,656	2001219
60 AGH 300T	300	1.20 mm	2,538	2001220
60 AGH 400T	400	1.50 mm	4,881	2001221
60 AGH 500T	500	1.50 mm	6,695	2001222
60 AGH 600T	600	1.50 mm	8,836	2001223

H100

Sipariş Kodu Order Code	W (mm)	T (mm)	Ağırlık (kg/ad) Weight (kg/pcs)	Barkod Kodu Barcode Code
100 AGH 100T	100	1.20 mm	1,330	2001224
100 AGH 160T	160	1.20 mm	1,558	2001225
100 AGH 200T	200	1.20 mm	2,020	2001226
100 AGH 300T	300	1.20 mm	2,948	2001227
100 AGH 400T	400	1.50 mm	5,487	2001228
100 AGH 500T	500	1.50 mm	7,372	2001229
100 AGH 600T	600	1.50 mm	9,583	2001230

H = YÜKSEKLİK = HEIGHT / W = GENİŞLİK = WIDTH / T = KALINLIK = THICKNESS

H AGH 100 T

Yükseklik Kanal Tipi Genişlik Modül
Height Type Width Module

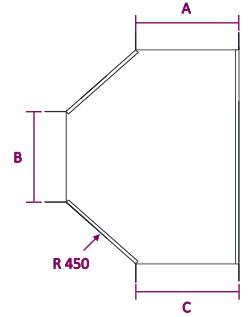
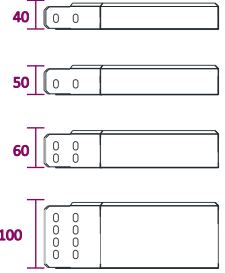

Dönüşlerde "A-B-C" ölçüleri esit olarak üretilmektedir. İsteğe bağlı olarak farklı ölçülerde üretim yapılır. Bends are produced same dimension for "A-B-C" as well as we can produce special dimensions regarding your inquiry.

ARTIM METAL ELEKTRİK A.Ş.

* Farklı kalınlık ve ölçülerde üretim yapılabılır.
* Malzeme ağırlıkları yaklaşık değerlerdir, ± %10 değişiklik gösterebilir.
* Malzeme kalınlık toleransı ± %10 dur.
* Lütfen siparişlerinizde sipariş kodu veya ürün kodu ve Kaplama şeklini belirtiniz.

* We can produce cable trays different thickness and dimensions
* Cable trays are shown approximately weight, they could change ± %10 difference.
* Cable trays thickness tolerances are shown ± %10 .
* Please indicate order code and coating type in your orders.

AGH SERIES

T BAĞLANTI R450 (MODEL1)

T BEND R450 (MODEL1)

SICAK DALDIRMA (SD)

HOT DIP GALVANIZED (HDG)

TS EN ISO 1461



H40 = H50 Tek delikli
H40 = H50 One hole

H40

Sipariş Kodu Order Code	W (mm)	T (mm)	Ağırlık (kg/ad) Weight (kg/pcs)	Barkod Kodu Barcode Code
40 AGH 050T	50	1.50 mm	0,464	2001200
40 AGH 100T	100	1.50 mm	1,137	2001201
40 AGH 120T	120	1.50 mm	1,296	2001202
40 AGH 160T	160	1.50 mm	1,454	2001203
40 AGH 200T	200	1.50 mm	1,969	2001204
40 AGH 300T	300	1.50 mm	3,144	2001205
40 AGH 400T	400	2.00 mm	8,230	2001206
40 AGH 500T	500	2.00 mm	8,611	2001207
40 AGH 600T	600	2.00 mm	11,481	2001208

H50

Sipariş Kodu Order Code	W (mm)	T (mm)	Ağırlık (kg/ad) Weight (kg/pcs)	Barkod Kodu Barcode Code
50 AGH 050T	50	1.50 mm	0,534	2001209
50 AGH 100T	100	1.50 mm	1,264	2001210
50 AGH 160T	160	1.50 mm	1,575	2001211
50 AGH 200T	200	1.50 mm	2,122	2001212
50 AGH 300T	300	1.50 mm	3,302	2001213
50 AGH 400T	400	2.00 mm	6,401	2001214
50 AGH 500T	500	2.00 mm	8,859	2001215
50 AGH 600T	600	2.00 mm	11,755	2001216

H60

Sipariş Kodu Order Code	W (mm)	T (mm)	Ağırlık (kg/ad) Weight (kg/pcs)	Barkod Kodu Barcode Code
60 AGH 100T	100	1.50 mm	1,384	2001217
60 AGH 160T	160	1.50 mm	1,695	2001218
60 AGH 200T	200	1.50 mm	2,255	2001219
60 AGH 300T	300	1.50 mm	3,455	2001220
60 AGH 400T	400	2.00 mm	6,642	2001221
60 AGH 500T	500	2.00 mm	9,113	2001222
60 AGH 600T	600	2.00 mm	12,028	2001223

H100

Sipariş Kodu Order Code	W (mm)	T (mm)	Ağırlık (kg/ad) Weight (kg/pcs)	Barkod Kodu Barcode Code
100 AGH 100T	100	1.50 mm	1,811	2001224
100 AGH 160T	160	1.50 mm	2,122	2001225
100 AGH 200T	200	1.50 mm	2,750	2001226
100 AGH 300T	300	1.50 mm	4,014	2001227
100 AGH 400T	400	2.00 mm	7,468	2001228
100 AGH 500T	500	2.00 mm	10,034	2001229
100 AGH 600T	600	2.00 mm	13,044	2001230

H = YÜKSEKLİK = HEIGHT / W = GENİŞLİK = WIDTH / T = KALINLIK = THICKNESS

H AGH 100 T

Yükseklik Kanal Tipi Genişlik Modül
Height Type Width Module

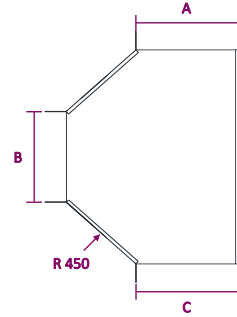

Dönüşlerde "A-B-C" ölçüleri esit olarak üretilmektedir. İsteğe bağlı olarak farklı ölçülerde üretim yapılır.

Bends are produced same dimension for "A-B-C" as well as we can produce special dimensions regarding your inquiry.

* Farklı kalınlık ve ölçülerde üretim yapılabılır.
* Malzeme ağırlıkları yaklaşık değerlerdir, ± %10 değişiklik gösterebilir.
* Malzeme kalınlık toleransı ± %10 dur.
* Lütfen siparişlerinizde sipariş kodu veya ürün kodu ve Kaplama şeklini belirtiniz.

* We can produce cable trays different thickness and dimensions
* Cable trays are shown approximately weight, they could change ± %10 difference.
* Cable trays thickness tolerances are shown ± %10 .
* Please indicate order code and coating type in your orders.

AGH SERIES

T BAGLANTI R600 (MODEL1)

T BEND R600 (MODEL1)

PREGALVANİZ (PG)
PREGALVANİZED (PG)
TS EN 10346



H40 = H50 Tek delikli
H40 = H50 One hole



H40

Sipariş Kodu Order Code	W (mm)	T (mm)	Ağırlık (kg/ad) Weight (kg/pcs)	Barkod Kodu Barcode Code
40 AGH 050T	50	1.20 mm	0,395	2001200
40 AGH 100T	100	1.20 mm	0,968	2001201
40 AGH 120T	120	1.20 mm	1,188	2001202
40 AGH 160T	160	1.20 mm	1,687	2001203
40 AGH 200T	200	1.20 mm	1,678	2001204
40 AGH 300T	300	1.20 mm	2,679	2001205
40 AGH 400T	400	1.50 mm	7,015	2001206
40 AGH 500T	500	1.50 mm	7,339	2001207
40 AGH 600T	600	1.50 mm	9,785	2001208

H50

Sipariş Kodu Order Code	W (mm)	T (mm)	Ağırlık (kg/ad) Weight (kg/pcs)	Barkod Kodu Barcode Code
50 AGH 050T	50	1.20 mm	0,454	2001209
50 AGH 100T	100	1.20 mm	1,076	2001210
50 AGH 160T	160	1.20 mm	1,343	2001211
50 AGH 200T	200	1.20 mm	1,807	2001212
50 AGH 300T	300	1.20 mm	2,814	2001213
50 AGH 400T	400	1.50 mm	5,456	2001214
50 AGH 500T	500	1.50 mm	7,550	2001215
50 AGH 600T	600	1.50 mm	10,018	2001216

H60

Sipariş Kodu Order Code	W (mm)	T (mm)	Ağırlık (kg/ad) Weight (kg/pcs)	Barkod Kodu Barcode Code
60 AGH 100T	100	1.20 mm	1,180	2001217
60 AGH 160T	160	1.20 mm	1,445	2001218
60 AGH 200T	200	1.20 mm	1,921	2001219
60 AGH 300T	300	1.20 mm	2,944	2001220
60 AGH 400T	400	1.50 mm	5,662	2001221
60 AGH 500T	500	1.50 mm	7,766	2001222
60 AGH 600T	600	1.50 mm	10,250	2001223

H100

Sipariş Kodu Order Code	W (mm)	T (mm)	Ağırlık (kg/ad) Weight (kg/pcs)	Barkod Kodu Barcode Code
100 AGH 100T	100	1.20 mm	1,542	2001224
100 AGH 160T	160	1.20 mm	1,807	2001225
100 AGH 200T	200	1.20 mm	2,344	2001226
100 AGH 300T	300	1.20 mm	3,420	2001227
100 AGH 400T	400	1.50 mm	6,365	2001228
100 AGH 500T	500	1.50 mm	8,551	2001229
100 AGH 600T	600	1.50 mm	11,116	2001230

H = YÜKSEKLİK = HEIGHT / W = GENİŞLİK = WIDTH / T = KALINLIK = THICKNESS

H AGH 100 T

Yükseklik Kanal Tipi Genişlik Modül
Height Type Width Module

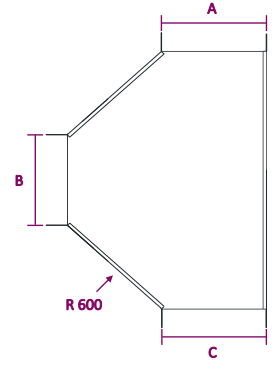
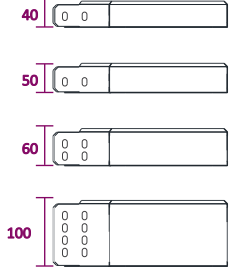

Dönüşlerde "A-B-C" ölçüleri esit olarak üretilmektedir. İsteğe bağlı olarak farklı ölçülerde üretim yapılır. Bends are produced same dimension for "A-B-C" as well as we can produce special dimensions regarding your inquiry.

ARTIM METAL ELEKTRİK A.Ş.

* Farklı kalınlık ve ölçülerde üretim yapılabılır.
* Malzeme ağırlıkları yaklaşık değerlerdir, ± %10 değişiklik gösterebilir.
* Malzeme kalınlık toleransı ± %10 dur.
* Lütfen siparişlerinizde sipariş kodu veya ürün kodu ve Kaplama şeklini belirtiniz.

* We can produce cable trays different thickness and dimensions
* Cable trays are shown approximately weight, they could change ± %10 difference.
* Cable trays thickness tolerances are shown ± %10 .
* Please indicate order code and coating type in your orders.

AGH SERIES

T BAGLANTI R600 (MODEL1)

T BEND R600 (MODEL1)

SICAK DALDIRMA (SD)

HOT DIP GALVANIZED (HDG)

TS EN ISO 1461



H40 = H50 Tek delikli
H40 = H50 One hole



H40

Sipariş Kodu Order Code	W (mm)	T (mm)	Ağırlık (kg/ad) Weight (kg/pcs)	Barkod Kodu Barcode Code
40 AGH 050T	50	1.50 mm	0,538	2001200
40 AGH 100T	100	1.50 mm	1,318	2001201
40 AGH 120T	120	1.50 mm	1,503	2001202
40 AGH 160T	160	1.50 mm	1,687	2001203
40 AGH 200T	200	1.50 mm	2,284	2001204
40 AGH 300T	300	1.50 mm	3,647	2001205
40 AGH 400T	400	2.00 mm	9,546	2001206
40 AGH 500T	500	2.00 mm	9,988	2001207
40 AGH 600T	600	2.00 mm	13,318	2001208

H50

Sipariş Kodu Order Code	W (mm)	T (mm)	Ağırlık (kg/ad) Weight (kg/pcs)	Barkod Kodu Barcode Code
50 AGH 050T	50	1.50 mm	0,619	2001209
50 AGH 100T	100	1.50 mm	1,466	2001210
50 AGH 160T	160	1.50 mm	1,827	2001211
50 AGH 200T	200	1.50 mm	2,461	2001212
50 AGH 300T	300	1.50 mm	3,831	2001213
50 AGH 400T	400	2.00 mm	7,425	2001214
50 AGH 500T	500	2.00 mm	10,277	2001215
50 AGH 600T	600	2.00 mm	13,635	2001216

H60

Sipariş Kodu Order Code	W (mm)	T (mm)	Ağırlık (kg/ad) Weight (kg/pcs)	Barkod Kodu Barcode Code
60 AGH 100T	100	1.50 mm	1,606	2001217
60 AGH 160T	160	1.50 mm	1,966	2001218
60 AGH 200T	200	1.50 mm	2,616	2001219
60 AGH 300T	300	1.50 mm	4,008	2001220
60 AGH 400T	400	2.00 mm	7,705	2001221
60 AGH 500T	500	2.00 mm	10,572	2001222
60 AGH 600T	600	2.00 mm	13,953	2001223

H100

Sipariş Kodu Order Code	W (mm)	T (mm)	Ağırlık (kg/ad) Weight (kg/pcs)	Barkod Kodu Barcode Code
100 AGH 100T	100	1.50 mm	2,100	2001224
100 AGH 160T	160	1.50 mm	2,461	2001225
100 AGH 200T	200	1.50 mm	3,190	2001226
100 AGH 300T	300	1.50 mm	4,656	2001227
100 AGH 400T	400	2.00 mm	8,662	2001228
100 AGH 500T	500	2.00 mm	11,639	2001229
100 AGH 600T	600	2.00 mm	15,131	2001230

H = YÜKSEKLİK = HEIGHT / W = GENİŞLİK = WIDTH / T = KALINLIK = THICKNESS

H AGH 100 T

Yükseklik Kanal Tipi Genişlik Modül
Height Type Width Module

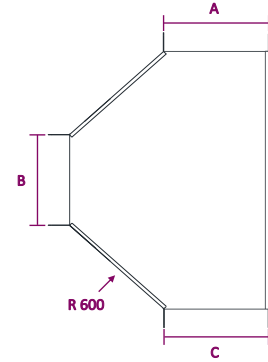
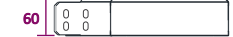

Dönüşlerde "A-B-C" ölçüleri esit olarak üretilmektedir. İsteğe bağlı olarak farklı ölçülerde üretim yapılır.
Bends are produced same dimension for "A-B-C" as well as we can produce special dimensions regarding your inquiry.

* Farklı kalınlık ve ölçülerde üretim yapılabılır.
* Malzeme ağırlıkları yaklaşık değerlerdir, ± %10 değişiklik gösterebilir.
* Malzeme kalınlık toleransı ± %10 dur.
* Lütfen siparişlerinizde sipariş kodu veya ürün kodu ve Kaplama şeklini belirtiniz.

* We can produce cable trays different thickness and dimensions
* Cable trays are shown approximately weight, they could change ± %10 difference.
* Cable trays thickness tolerances are shown ± %10 .
* Please indicate order code and coating type in your orders.

AGH SERIES

DÖRTLÜ BAGLANTI R300 (MODEL1)

FOUR WAY CROSSING R300 (MODEL1)

PREGALVANİZ (PG)
PREGALVANIZED (PG)
TS EN 10346



H40 = H50 Tek delikli
H40 = H50 One hole



H40

Sipariş Kodu Order Code	W (mm)	T (mm)	Ağırlık (kg/ad) Weight (kg/pcs)	Barkod Kodu Barcode Code
40 AGH 050D	50	1.20 mm	0,326	2001300
40 AGH 100D	100	1.20 mm	0,812	2001301
40 AGH 120D	120	1.20 mm	0,975	2001302
40 AGH 160D	160	1.20 mm	0,996	2001303
40 AGH 200D	200	1.20 mm	1,322	2001304
40 AGH 300D	300	1.20 mm	2,037	2001305
40 AGH 400D	400	1.50 mm	3,931	2001306
40 AGH 500D	500	1.50 mm	5,412	2001307
40 AGH 600D	600	1.50 mm	7,169	2001308

H50

Sipariş Kodu Order Code	W (mm)	T (mm)	Ağırlık (kg/ad) Weight (kg/pcs)	Barkod Kodu Barcode Code
50 AGH 050D	50	1.20 mm	0,369	2001309
50 AGH 100D	100	1.20 mm	0,894	2001310
50 AGH 160D	160	1.20 mm	0,982	2001311
50 AGH 200D	200	1.20 mm	1,407	2001312
50 AGH 300D	300	1.20 mm	2,119	2001313
50 AGH 400D	400	1.50 mm	4,036	2001314
50 AGH 500D	500	1.50 mm	5,529	2001315
50 AGH 600D	600	1.50 mm	7,278	2001316

H60

Sipariş Kodu Order Code	W (mm)	T (mm)	Ağırlık (kg/ad) Weight (kg/pcs)	Barkod Kodu Barcode Code
60 AGH 100D	100	1.20 mm	0,972	2001317
60 AGH 160D	160	1.20 mm	1,143	2001318
60 AGH 200D	200	1.20 mm	1,489	2001319
60 AGH 300D	300	1.20 mm	2,197	2001320
60 AGH 400D	400	1.50 mm	4,148	2001321
60 AGH 500D	500	1.50 mm	5,638	2001322
60 AGH 600D	600	1.50 mm	7,387	2001323

H100

Sipariş Kodu Order Code	W (mm)	T (mm)	Ağırlık (kg/ad) Weight (kg/pcs)	Barkod Kodu Barcode Code
100 AGH 100D	100	1.20 mm	1,256	2001324
100 AGH 160D	160	1.20 mm	1,400	2001325
100 AGH 200D	200	1.20 mm	1,765	2001326
100 AGH 300D	300	1.20 mm	2,481	2001327
100 AGH 400D	400	1.50 mm	4,518	2001328
100 AGH 500D	500	1.50 mm	6,003	2001329
100 AGH 600D	600	1.50 mm	7,761	2001330

H = YÜKSEKLİK = HEIGHT / W = GENİŞLİK = WIDTH / T = KALINLIK = THICKNESS

H AGH 100 D

Yükseklik Kanal Tipi Genişlik Modül
Height Type Width Module

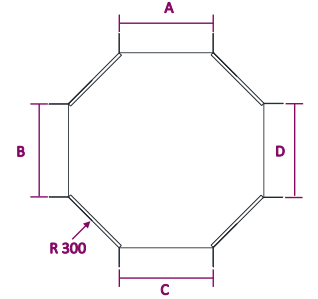
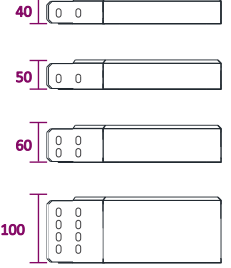

Dönüşlerde "A-B-C-D" ölçüleri esit olarak üretilmektedir. İsteğe bağlı olarak farklı ölçülerde üretim yapılır. Bends are produced same dimension for "A-B-C-D" as well as we can produce special dimensions regarding your inquiry.

ARTIM METAL ELEKTRİK A.Ş.

* Farklı kalınlık ve ölçülerde üretim yapılabılır.
* Malzeme ağırlıkları yaklaşık değerlerdir, ± %10 değişiklik gösterebilir.
* Malzeme kalınlık toleransı ± %10 dur.
* Lütfen siparişlerinizde sipariş kodu veya ürün kodu ve Kaplama şeklini belirtiniz.

* We can produce cable trays different thickness and dimensions
* Cable trays are shown approximately weight, they could change ± %10 difference.
* Cable trays thickness tolerances are shown ± %10 .
* Please indicate order code and coating type in your orders.

AGH SERIES

DÖRTLÜ BAGLANTI R300 (MODEL1)

FOUR WAY CROSSING R300 (MODEL1)

SICAK DALDIRMA (SD)

HOT DIP GALVANIZED (HDG)

TS EN ISO 1461



H40 = H50 Tek delikli
H40 = H50 One hole

H40

Sipariş Kodu Order Code	W (mm)	T (mm)	Ağırlık (kg/ad) Weight (kg/pcs)	Barkod Kodu Barcode Code
40 AGH 050D	50	1.50 mm	0,445	2001300
40 AGH 100D	100	1.50 mm	1,106	2001301
40 AGH 120D	120	1.50 mm	1,230	2001302
40 AGH 160D	160	1.50 mm	1,354	2001303
40 AGH 200D	200	1.50 mm	1,799	2001304
40 AGH 300D	300	1.50 mm	2,773	2001305
40 AGH 400D	400	2.00 mm	5,350	2001306
40 AGH 500D	500	2.00 mm	7,367	2001307
40 AGH 600D	600	2.00 mm	9,759	2001308

H50

Sipariş Kodu Order Code	W (mm)	T (mm)	Ağırlık (kg/ad) Weight (kg/pcs)	Barkod Kodu Barcode Code
50 AGH 050D	50	1.50 mm	0,503	2001309
50 AGH 100D	100	1.50 mm	1,217	2001310
50 AGH 160D	160	1.50 mm	1,456	2001311
50 AGH 200D	200	1.50 mm	1,916	2001312
50 AGH 300D	300	1.50 mm	2,885	2001313
50 AGH 400D	400	2.00 mm	5,493	2001314
50 AGH 500D	500	2.00 mm	7,525	2001315
50 AGH 600D	600	2.00 mm	9,907	2001316

H60

Sipariş Kodu Order Code	W (mm)	T (mm)	Ağırlık (kg/ad) Weight (kg/pcs)	Barkod Kodu Barcode Code
60 AGH 100D	100	1.50 mm	1,323	2001317
60 AGH 160D	160	1.50 mm	1,556	2001318
60 AGH 200D	200	1.50 mm	2,027	2001319
60 AGH 300D	300	1.50 mm	2,991	2001320
60 AGH 400D	400	2.00 mm	5,646	2001321
60 AGH 500D	500	2.00 mm	7,673	2001322
60 AGH 600D	600	2.00 mm	10,055	2001323

H100

Sipariş Kodu Order Code	W (mm)	T (mm)	Ağırlık (kg/ad) Weight (kg/pcs)	Barkod Kodu Barcode Code
100 AGH 100D	100	1.50 mm	1,710	2001324
100 AGH 160D	160	1.50 mm	1,905	2001325
100 AGH 200D	200	1.50 mm	2,403	2001326
100 AGH 300D	300	1.50 mm	3,376	2001327
100 AGH 400D	400	2.00 mm	6,150	2001328
100 AGH 500D	500	2.00 mm	8,171	2001329
100 AGH 600D	600	2.00 mm	10,562	2001330

H = YÜKSEKLİK = HEIGHT / W = GENİŞLİK = WIDTH / T = KALINLIK = THICKNESS

H AGH 100 D

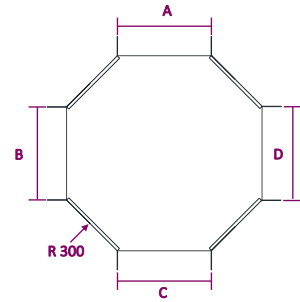
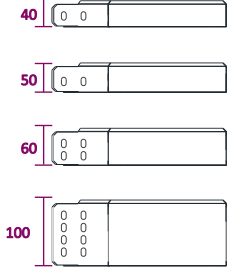

Dönüşlerde "A-B-C-D" ölçüleri esit olarak üretilmektedir. İsteğe bağlı olarak farklı ölçülerde üretim yapılır.

Bends are produced same dimension for "A-B-C-D" as well as we can produce special dimensions regarding your inquiry.

* Farklı kalınlık ve ölçülerde üretim yapılabılır.
* Malzeme ağırlıkları yaklaşık değerlerdir, ± %10 değişiklik gösterebilir.
* Malzeme kalınlık toleransı ± %10 dur.
* Lütfen siparişlerinizde sipariş kodu veya ürün kodu ve Kaplama şeklini belirtiniz.

* We can produce cable trays different thickness and dimensions
* Cable trays are shown approximately weight, they could change ± %10 difference.
* Cable trays thickness tolerances are shown ± %10 .
* Please indicate order code and coating type in your orders.

AGH SERIES

DÖRTLÜ BAGLANTI R450 (MODEL1)

FOUR WAY CROSSING R450 (MODEL1)

PREGALVANİZ (PG)
PREGALVANİZ (PG)
TS EN 10346



H40 = H50 Tek delikli
H40 = H50 One hole

H40

Sipariş Kodu Order Code	W (mm)	T (mm)	Ağırlık (kg/ad) Weight (kg/pcs)	Barkod Kodu Barcode Code
40 AGH 050D	50	1.20 mm	0,391	2001300
40 AGH 100D	100	1.20 mm	0,975	2001301
40 AGH 120D	120	1.20 mm	1,170	2001302
40 AGH 160D	160	1.20 mm	1,195	2001303
40 AGH 200D	200	1.20 mm	1,586	2001304
40 AGH 300D	300	1.20 mm	2,444	2001305
40 AGH 400D	400	1.50 mm	4,717	2001306
40 AGH 500D	500	1.50 mm	6,494	2001307
40 AGH 600D	600	1.50 mm	8,603	2001308

H50

Sipariş Kodu Order Code	W (mm)	T (mm)	Ağırlık (kg/ad) Weight (kg/pcs)	Barkod Kodu Barcode Code
50 AGH 050D	50	1.20 mm	0,443	2001309
50 AGH 100D	100	1.20 mm	1,073	2001310
50 AGH 160D	160	1.20 mm	1,178	2001311
50 AGH 200D	200	1.20 mm	1,689	2001312
50 AGH 300D	300	1.20 mm	2,543	2001313
50 AGH 400D	400	1.50 mm	4,843	2001314
50 AGH 500D	500	1.50 mm	6,634	2001315
50 AGH 600D	600	1.50 mm	8,734	2001316

H60

Sipariş Kodu Order Code	W (mm)	T (mm)	Ağırlık (kg/ad) Weight (kg/pcs)	Barkod Kodu Barcode Code
60 AGH 100D	100	1.20 mm	1,166	2001317
60 AGH 160D	160	1.20 mm	1,371	2001318
60 AGH 200D	200	1.20 mm	1,787	2001319
60 AGH 300D	300	1.20 mm	2,636	2001320
60 AGH 400D	400	1.50 mm	4,978	2001321
60 AGH 500D	500	1.50 mm	6,765	2001322
60 AGH 600D	600	1.50 mm	8,865	2001323

H100

Sipariş Kodu Order Code	W (mm)	T (mm)	Ağırlık (kg/ad) Weight (kg/pcs)	Barkod Kodu Barcode Code
100 AGH 100D	100	1.20 mm	1,507	2001324
100 AGH 160D	160	1.20 mm	1,680	2001325
100 AGH 200D	200	1.20 mm	2,118	2001326
100 AGH 300D	300	1.20 mm	2,977	2001327
100 AGH 400D	400	1.50 mm	5,421	2001328
100 AGH 500D	500	1.50 mm	7,203	2001329
100 AGH 600D	600	1.50 mm	9,313	2001330

H = YÜKSEKLİK = HEIGHT / W = GENİŞLİK = WIDTH / T = KALINLIK = THICKNESS

H AGH 100 D

Yükseklik Kanal Tipi Genişlik Modül
Height Type Width Module

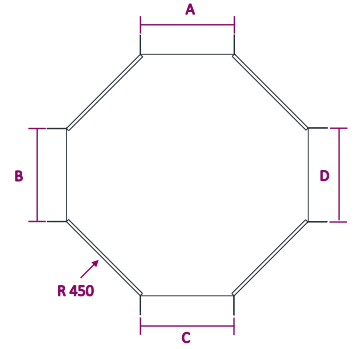
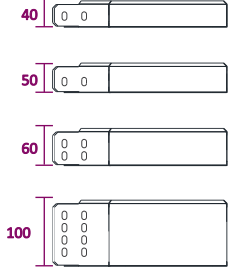

Dönüşlerde "A-B-C-D" ölçüleri esit olarak üretilmektedir. İsteğe bağlı olarak farklı ölçülerde üretim yapılır. Bends are produced same dimension for "A-B-C-D" as well as we can produce special dimensions regarding your inquiry.

ARTIM METAL ELEKTRİK A.Ş.

* Farklı kalınlık ve ölçülerde üretim yapılabılır.
* Malzeme ağırlıkları yaklaşık değerlerdir, ± %10 değişiklik gösterebilir.
* Malzeme kalınlık toleransı ± %10 dur.
* Lütfen siparişlerinizde sipariş kodu veya ürün kodu ve Kaplama şeklini belirtiniz.

* We can produce cable trays different thickness and dimensions
* Cable trays are shown approximately weight, they could change ± %10 difference.
* Cable trays thickness tolerances are shown ± %10 .
* Please indicate order code and coating type in your orders.

AGH SERIES

DÖRTLÜ BAGLANTI R450 (MODEL1)

FOUR WAY CROSSING R450 (MODEL1)

SICAK DALDIRMA (SD)

HOT DIP GALVANIZED (SD)

TS EN ISO 1461



H40 = H50 Tek delikli
H40 = H50 One hole



H40

Sipariş Kodu Order Code	W (mm)	T (mm)	Ağırlık (kg/ad) Weight (kg/pcs)	Barkod Kodu Barcode Code
40 AGH 050D	50	1.50 mm	0,534	2001300
40 AGH 100D	100	1.50 mm	1,327	2001301
40 AGH 120D	120	1.50 mm	1,476	2001302
40 AGH 160D	160	1.50 mm	1,625	2001303
40 AGH 200D	200	1.50 mm	2,159	2001304
40 AGH 300D	300	1.50 mm	3,328	2001305
40 AGH 400D	400	2.00 mm	6,420	2001306
40 AGH 500D	500	2.00 mm	8,840	2001307
40 AGH 600D	600	2.00 mm	11,711	2001308

H50

Sipariş Kodu Order Code	W (mm)	T (mm)	Ağırlık (kg/ad) Weight (kg/pcs)	Barkod Kodu Barcode Code
50 AGH 050D	50	1.50 mm	0,604	2001309
50 AGH 100D	100	1.50 mm	1,461	2001310
50 AGH 160D	160	1.50 mm	1,747	2001311
50 AGH 200D	200	1.50 mm	2,299	2001312
50 AGH 300D	300	1.50 mm	3,462	2001313
50 AGH 400D	400	2.00 mm	6,591	2001314
50 AGH 500D	500	2.00 mm	9,031	2001315
50 AGH 600D	600	2.00 mm	11,888	2001316

H60

Sipariş Kodu Order Code	W (mm)	T (mm)	Ağırlık (kg/ad) Weight (kg/pcs)	Barkod Kodu Barcode Code
60 AGH 100D	100	1.50 mm	1,588	2001317
60 AGH 160D	160	1.50 mm	1,868	2001318
60 AGH 200D	200	1.50 mm	2,433	2001319
60 AGH 300D	300	1.50 mm	3,589	2001320
60 AGH 400D	400	2.00 mm	6,775	2001321
60 AGH 500D	500	2.00 mm	9,208	2001322
60 AGH 600D	600	2.00 mm	12,066	2001323

H100

Sipariş Kodu Order Code	W (mm)	T (mm)	Ağırlık (kg/ad) Weight (kg/pcs)	Barkod Kodu Barcode Code
100 AGH 100D	100	1.50 mm	2,052	2001324
100 AGH 160D	160	1.50 mm	2,286	2001325
100 AGH 200D	200	1.50 mm	2,884	2001326
100 AGH 300D	300	1.50 mm	4,051	2001327
100 AGH 400D	400	2.00 mm	7,379	2001328
100 AGH 500D	500	2.00 mm	9,806	2001329
100 AGH 600D	600	2.00 mm	12,675	2001330

H = YÜKSEKLİK = HEIGHT / W = GENİŞLİK = WIDTH / T = KALINLIK = THICKNESS

H AGH 100 D

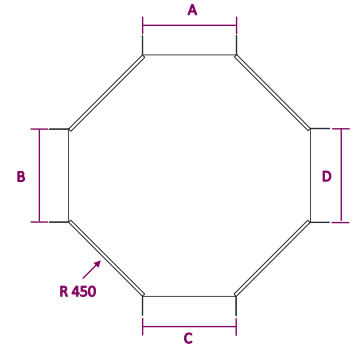
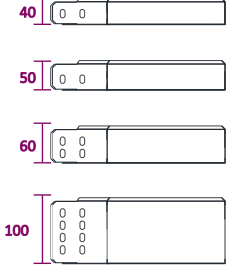

Dönüşlerde "A-B-C-D" ölçüleri esit olarak üretilmektedir. İsteğe bağlı olarak farklı ölçülerde üretim yapılır.

Bends are produced same dimension for "A-B-C-D" as well as we can produce special dimensions regarding your inquiry.

* Farklı kalınlık ve ölçülerde üretim yapılabılır.
* Malzeme ağırlıkları yaklaşık değerlerdir, ± %10 değişiklik gösterebilir.
* Malzeme kalınlık toleransı ± %10 dur.
* Lütfen siparişlerinizde sipariş kodu veya ürün kodu ve Kaplama şeklini belirtiniz.

* We can produce cable trays different thickness and dimensions
* Cable trays are shown approximately weight, they could change ± %10 difference.
* Cable trays thickness tolerances are shown ± %10 .
* Please indicate order code and coating type in your orders.

AGH SERIES

DÖRTLÜ BAGLANTI R600 (MODEL1)

FOUR WAY CROSSING R600 (MODEL1)

PREGALVANİZ (PG)
PREGALVANİZ (PG)
TS EN 10346



H40 = H50 Tek delikli
H40 = H50 One hole



H40

Sipariş Kodu Order Code	W (mm)	T (mm)	Ağırlık (kg/ad) Weight (kg/pcs)	Barkod Kodu Barcode Code
40 AGH 050D	50	1.20 mm	0,454	2001300
40 AGH 100D	100	1.20 mm	1,131	2001301
40 AGH 120D	120	1.20 mm	1,358	2001302
40 AGH 160D	160	1.20 mm	1,386	2001303
40 AGH 200D	200	1.20 mm	1,840	2001304
40 AGH 300D	300	1.20 mm	2,835	2001305
40 AGH 400D	400	1.50 mm	5,472	2001306
40 AGH 500D	500	1.50 mm	7,533	2001307
40 AGH 600D	600	1.50 mm	9,979	2001308

H50

Sipariş Kodu Order Code	W (mm)	T (mm)	Ağırlık (kg/ad) Weight (kg/pcs)	Barkod Kodu Barcode Code
50 AGH 050D	50	1.20 mm	0,514	2001309
50 AGH 100D	100	1.20 mm	1,245	2001310
50 AGH 160D	160	1.20 mm	1,367	2001311
50 AGH 200D	200	1.20 mm	1,959	2001312
50 AGH 300D	300	1.20 mm	2,950	2001313
50 AGH 400D	400	1.50 mm	5,618	2001314
50 AGH 500D	500	1.50 mm	7,696	2001315
50 AGH 600D	600	1.50 mm	10,131	2001316

H60

Sipariş Kodu Order Code	W (mm)	T (mm)	Ağırlık (kg/ad) Weight (kg/pcs)	Barkod Kodu Barcode Code
60 AGH 100D	100	1.20 mm	1,353	2001317
60 AGH 160D	160	1.20 mm	1,591	2001318
60 AGH 200D	200	1.20 mm	2,073	2001319
60 AGH 300D	300	1.20 mm	3,058	2001320
60 AGH 400D	400	1.50 mm	5,774	2001321
60 AGH 500D	500	1.50 mm	7,848	2001322
60 AGH 600D	600	1.50 mm	10,283	2001323

H100

Sipariş Kodu Order Code	W (mm)	T (mm)	Ağırlık (kg/ad) Weight (kg/pcs)	Barkod Kodu Barcode Code
100 AGH 100D	100	1.20 mm	1,748	2001324
100 AGH 160D	160	1.20 mm	1,948	2001325
100 AGH 200D	200	1.20 mm	2,456	2001326
100 AGH 300D	300	1.20 mm	3,453	2001327
100 AGH 400D	400	1.50 mm	6,289	2001328
100 AGH 500D	500	1.50 mm	8,356	2001329
100 AGH 600D	600	1.50 mm	10,803	2001330

H = YÜKSEKLİK = HEIGHT / W = GENİŞLİK = WIDTH / T = KALINLIK = THICKNESS

H AGH 100 D

Yükseklik Kanal Tipi Genişlik Modül
Height Type Width Module

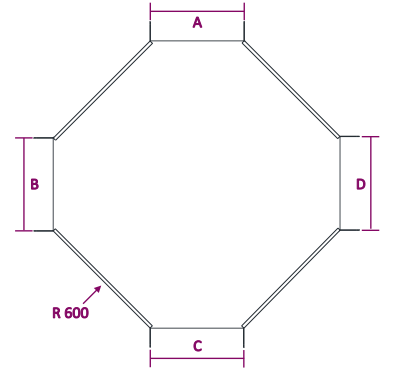
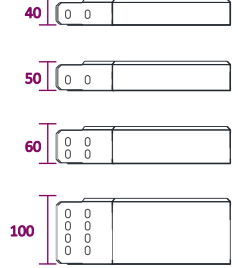

Dönüşlerde "A-B-C-D" ölçüleri esit olarak üretilmektedir. İsteğe bağlı olarak farklı ölçülerde üretim yapılır. Bends are produced same dimension for "A-B-C-D" as well as we can produce special dimensions regarding your inquiry.

ARTIM METAL ELEKTRİK A.Ş.

* Farklı kalınlık ve ölçülerde üretim yapılabılır.
* Malzeme ağırlıkları yaklaşık değerlerdir, ± %10 değişiklik gösterebilir.
* Malzeme kalınlık toleransı ± %10 dur.
* Lütfen siparişlerinizde sipariş kodu veya ürün kodu ve Kaplama şeklini belirtiniz.

* We can produce cable trays different thickness and dimensions
* Cable trays are shown approximately weight, they could change ± %10 difference.
* Cable trays thickness tolerances are shown ± %10 .
* Please indicate order code and coating type in your orders.

AGH SERIES

DÖRTLÜ BAGLANTI R600 (MODEL1)

FOUR WAY CROSSING R600 (MODEL1)

SICAK DALDIRMA (SD)

HOT DIP GALVANIZED (SD)

TS EN ISO 1461



Sipariş Kodu Order Code	W (mm)	T (mm)	Ağırlık (kg/ad) Weight (kg/pcs)	Barkod Kodu Barcode Code
40 AGH 050D	50	1.50 mm	0,619	2001300
40 AGH 100D	100	1.50 mm	1,539	2001301
40 AGH 120D	120	1.50 mm	1,712	2001302
40 AGH 160D	160	1.50 mm	1,885	2001303
40 AGH 200D	200	1.50 mm	2,505	2001304
40 AGH 300D	300	1.50 mm	3,861	2001305
40 AGH 400D	400	2.00 mm	7,448	2001306
40 AGH 500D	500	2.00 mm	10,254	2001307
40 AGH 600D	600	2.00 mm	13,584	2001308

H40

H AGH 100 D

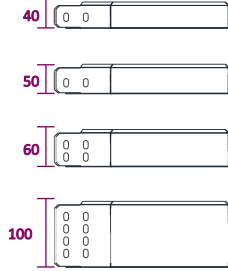

H40 = H50 Tek delikli
H40 = H50 One hole

Sipariş Kodu Order Code	W (mm)	T (mm)	Ağırlık (kg/ad) Weight (kg/pcs)	Barkod Kodu Barcode Code
50 AGH 050D	50	1.50 mm	0,701	2001309
50 AGH 100D	100	1.50 mm	1,694	2001310
50 AGH 160D	160	1.50 mm	2,027	2001311
50 AGH 200D	200	1.50 mm	2,667	2001312
50 AGH 300D	300	1.50 mm	4,015	2001313
50 AGH 400D	400	2.00 mm	7,646	2001314
50 AGH 500D	500	2.00 mm	10,475	2001315
50 AGH 600D	600	2.00 mm	13,790	2001316

H50

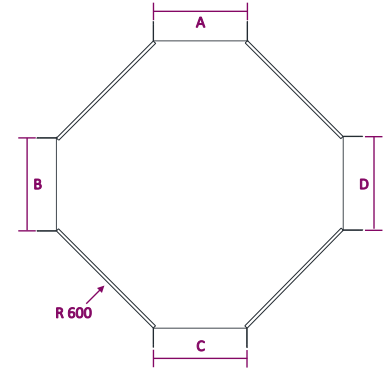

Dönüşlerde "A-B-C-D" ölçüleri esit olarak üretilmektedir. İsteğe bağlı olarak farklı ölçülerde üretim yapılır.

Bends are produced same dimension for "A-B-C-D" as well as we can produce special dimensions regarding your inquiry.

Sipariş Kodu Order Code	W (mm)	T (mm)	Ağırlık (kg/ad) Weight (kg/pcs)	Barkod Kodu Barcode Code
60 AGH 100D	100	1.50 mm	1,842	2001317
60 AGH 160D	160	1.50 mm	2,166	2001318
60 AGH 200D	200	1.50 mm	2,822	2001319
60 AGH 300D	300	1.50 mm	4,163	2001320
60 AGH 400D	400	2.00 mm	7,860	2001321
60 AGH 500D	500	2.00 mm	10,681	2001322
60 AGH 600D	600	2.00 mm	13,996	2001323

H60

Sipariş Kodu Order Code	W (mm)	T (mm)	Ağırlık (kg/ad) Weight (kg/pcs)	Barkod Kodu Barcode Code
100 AGH 100D	100	1.50 mm	2,380	2001324
100 AGH 160D	160	1.50 mm	2,652	2001325
100 AGH 200D	200	1.50 mm	3,345	2001326
100 AGH 300D	300	1.50 mm	4,700	2001327
100 AGH 400D	400	2.00 mm	8,560	2001328
100 AGH 500D	500	2.00 mm	11,374	2001329
100 AGH 600D	600	2.00 mm	14,703	2001330

H100

H = YÜKSEKLİK = HEIGHT / W = GENİŞLİK = WIDTH / T = KALINLIK = THICKNESS

* Farklı kalınlık ve ölçülerde üretim yapıla bilinir.
* Malzeme ağırlıkları yaklaşık değerlerdir, ± %10 değişiklik gösterebilir.
* Malzeme kalınlık toleransı ± %10 dur.
* Lütfen siparişlerinizde sipariş kodu veya ürün kodu ve Kaplama şeklini belirtiniz.

* We can produce cable trays different thickness and dimensions
* Cable trays are shown approximately weight, they could change ± %10 difference.
* Cable trays thickness tolerances are shown ± %10 .
* Please indicate order code and coating type in your orders.

AGH SERIES

45° YATAY DÖNÜS

45° BEND

PREGALVANİZ (PG)
PREGALVANİZ (PG)
TS EN 10346



H40 = H50 Tek delikli
H40 = H50 One hole
H60 = Çift delikli
H60 = Double hole
H100 = Dört delikli
H100 = Four holes

H40

Sipariş Kodu Order Code	W (mm)	T (mm)	Ağırlık (kg/ad) Weight (kg/pcs)	Barkod Kodu Barcode Code
40 AGH 050Y (45°)	50	1.20 mm	0,616	2001150
40 AGH 100Y (45°)	100	1.20 mm	0,767	2001151
40 AGH 120Y (45°)	120	1.20 mm	0,804	2001152
40 AGH 160Y (45°)	160	1.20 mm	0,878	2001153
40 AGH 200Y (45°)	200	1.20 mm	1,112	2001154
40 AGH 300Y (45°)	300	1.20 mm	2,336	2001155
40 AGH 400Y (45°)	400	1.50 mm	4,050	2001156
40 AGH 500Y (45°)	500	1.50 mm	5,069	2001157
40 AGH 600Y (45°)	600	1.50 mm	6,206	2001158

H50

Sipariş Kodu Order Code	W (mm)	T (mm)	Ağırlık (kg/ad) Weight (kg/pcs)	Barkod Kodu Barcode Code
50 AGH 050Y (45°)	50	1.20 mm	0,702	2001159
50 AGH 100Y (45°)	100	1.20 mm	0,853	2001160
50 AGH 160Y (45°)	160	1.20 mm	0,965	2001161
50 AGH 200Y (45°)	200	1.20 mm	1,213	2001162
50 AGH 300Y (45°)	300	1.20 mm	2,484	2001163
50 AGH 400Y (45°)	400	1.50 mm	4,241	2001164
50 AGH 500Y (45°)	500	1.50 mm	5,288	2001165
50 AGH 600Y (45°)	600	1.50 mm	6,430	2001166

H60

Sipariş Kodu Order Code	W (mm)	T (mm)	Ağırlık (kg/ad) Weight (kg/pcs)	Barkod Kodu Barcode Code
60 AGH 100Y (45°)	100	1.20 mm	0,947	2001167
60 AGH 160Y (45°)	160	1.20 mm	1,051	2001168
60 AGH 200Y (45°)	200	1.20 mm	1,318	2001169
60 AGH 300Y (45°)	300	1.20 mm	2,412	2001170
60 AGH 400Y (45°)	400	1.50 mm	4,450	2001171
60 AGH 500Y (45°)	500	1.50 mm	5,494	2001172
60 AGH 600Y (45°)	600	1.50 mm	6,649	2001173

H100

Sipariş Kodu Order Code	W (mm)	T (mm)	Ağırlık (kg/ad) Weight (kg/pcs)	Barkod Kodu Barcode Code
100 AGH 100Y (45°)	100	1.20 mm	1,285	2001174
100 AGH 160Y (45°)	160	1.20 mm	1,375	2001175
100 AGH 200Y (45°)	200	1.20 mm	1,681	2001176
100 AGH 300Y (45°)	300	1.20 mm	3,168	2001177
100 AGH 400Y (45°)	400	1.50 mm	5,224	2001178
100 AGH 500Y (45°)	500	1.50 mm	6,314	2001179
100 AGH 600Y (45°)	600	1.50 mm	7,506	2001180

H = YÜKSEKLİK = HEIGHT / W = GENİŞLİK = WIDTH / T = KALINLIK = THICKNESS

H AGH 100Y (45°)

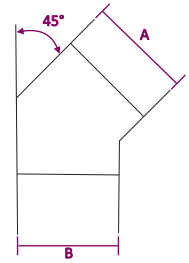

ARTIM METAL ELEKTRİK A.Ş.

* Farklı kalınlık ve ölçülerde üretim yapılabılır.
* Malzeme ağırlıkları yaklaşık değerlerdir, ± %10 değişiklik gösterebilir.
* Malzeme kalınlık toleransı ± %10 dur.
* Lütfen siparişlerinizde sipariş kodu veya ürün kodu ve Kaplama şeklini belirtiniz.

* We can produce cable trays different thickness and dimensions
* Cable trays are shown approximately weight, they could change ± %10 difference.
* Cable trays thickness tolerances are shown ± %10 .
* Please indicate order code and coating type in your orders.

AGH SERIES

45° YATAY DÖNÜS

45° BEND

SICAK DALDIRMA (SD)

HOT DIP GALVANIZED (SD)

TS EN ISO 1461



H40 = H50 Tek delikli
H40 = H50 One hole

H60 = Çift delikli
H60 = Double hole

H100 = Dört delikli
H100 = Four holes



H40

Sipariş Kodu Order Code	W (mm)	T (mm)	Ağırlık (kg/ad) Weight (kg/pcs)	Barkod Kodu Barcode Code
40 AGH 050Y (45°)	50	1.50 mm	0,838	2001150
40 AGH 100Y (45°)	100	1.50 mm	1,044	2001151
40 AGH 120Y (45°)	120	1.50 mm	1,120	2001152
40 AGH 160Y (45°)	160	1.50 mm	1,196	2001153
40 AGH 200Y (45°)	200	1.50 mm	1,514	2001154
40 AGH 300Y (45°)	300	1.50 mm	3,180	2001155
40 AGH 400Y (45°)	400	2.00 mm	5,513	2001156
40 AGH 500Y (45°)	500	2.00 mm	6,899	2001157
40 AGH 600Y (45°)	600	2.00 mm	8,448	2001158

H50

Sipariş Kodu Order Code	W (mm)	T (mm)	Ağırlık (kg/ad) Weight (kg/pcs)	Barkod Kodu Barcode Code
50 AGH 050Y (45°)	50	1.50 mm	0,956	2001159
50 AGH 100Y (45°)	100	1.50 mm	1,161	2001160
50 AGH 160Y (45°)	160	1.50 mm	1,313	2001161
50 AGH 200Y (45°)	200	1.50 mm	1,651	2001162
50 AGH 300Y (45°)	300	1.50 mm	3,381	2001163
50 AGH 400Y (45°)	400	2.00 mm	5,772	2001164
50 AGH 500Y (45°)	500	2.00 mm	7,198	2001165
50 AGH 600Y (45°)	600	2.00 mm	8,751	2001166

H60

Sipariş Kodu Order Code	W (mm)	T (mm)	Ağırlık (kg/ad) Weight (kg/pcs)	Barkod Kodu Barcode Code
60 AGH 100Y (45°)	100	1.50 mm	1,289	2001167
60 AGH 160Y (45°)	160	1.50 mm	1,431	2001168
60 AGH 200Y (45°)	200	1.50 mm	1,793	2001169
60 AGH 300Y (45°)	300	1.50 mm	3,283	2001170
60 AGH 400Y (45°)	400	2.00 mm	6,056	2001171
60 AGH 500Y (45°)	500	2.00 mm	7,477	2001172
60 AGH 600Y (45°)	600	2.00 mm	9,050	2001173

H100

Sipariş Kodu Order Code	W (mm)	T (mm)	Ağırlık (kg/ad) Weight (kg/pcs)	Barkod Kodu Barcode Code
100 AGH 100Y (45°)	100	1.50 mm	1,794	2001174
100 AGH 160Y (45°)	160	1.50 mm	1,872	2001175
100 AGH 200Y (45°)	200	1.50 mm	2,288	2001176
100 AGH 300Y (45°)	300	1.50 mm	4,312	2001177
100 AGH 400Y (45°)	400	2.00 mm	7,110	2001178
100 AGH 500Y (45°)	500	2.00 mm	8,595	2001179
100 AGH 600Y (45°)	600	2.00 mm	10,217	2001180

H = YÜKSEKLİK = HEIGHT / W = GENİŞLİK = WIDTH / T = KALINLIK = THICKNESS

H AGH 100Y (45°)

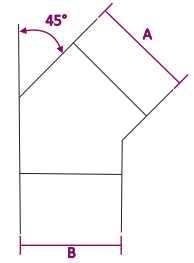
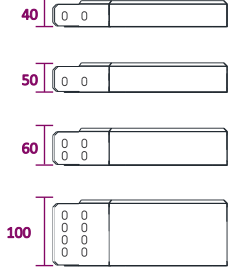

* Farklı kalınlık ve ölçülerde üretim yapılabilmektedir.
* Malzeme ağırlıkları yaklaşık değerlerdir, \pm %10 değişiklik gösterebilir.
* Malzeme kalınlık toleransı \pm %10 dur.
* Lütfen siparişlerinizde sipariş kodu veya ürün kodu ve kaplama şeklini belirtiniz.

* We can produce cable trays different thickness and dimensions
* Cable trays are shown approximately weight, they could change \pm %10 difference.
* Cable trays thickness tolerances are shown \pm %10 .
* Please indicate order code and coating type in your orders.

AGH SERIES

YARIM T BAĞLANTI

ADD-ON TEES

PREGALVANIZ (PG)
PREGALVANIZED (PG)
TS EN 10346

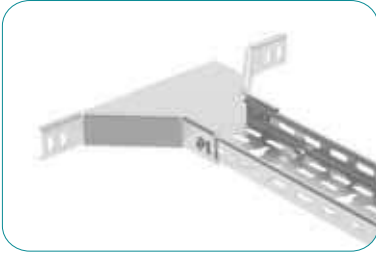

H40

Sipariş Kodu Order Code	W (mm)	T (mm)	Ağırlık (kg/ad) Weight (kg/pcs)	Barkod Kodu Barcode Code
40 AGH 100TT	100	1.20 mm	0,354	2001800
40 AGH 160TT	160	1.20 mm	0,781	2001801
40 AGH 200TT	200	1.20 mm	0,678	2001802
40 AGH 300TT	300	1.20 mm	1,195	2001803
40 AGH 400TT	400	1.50 mm	3,929	2001804
40 AGH 500TT	500	1.50 mm	3,996	2001805
40 AGH 600TT	600	1.50 mm	5,474	2001806

H50

Sipariş Kodu Order Code	W (mm)	T (mm)	Ağırlık (kg/ad) Weight (kg/pcs)	Barkod Kodu Barcode Code
50 AGH 100TT	100	1.20 mm	0,426	2001807
50 AGH 160TT	160	1.20 mm	0,552	2001808
50 AGH 200TT	200	1.20 mm	0,764	2001809
50 AGH 300TT	300	1.20 mm	1,285	2001810
50 AGH 400TT	400	1.50 mm	2,892	2001811
50 AGH 500TT	500	1.50 mm	4,136	2001812
50 AGH 600TT	600	1.50 mm	5,629	2001813

H60

Sipariş Kodu Order Code	W (mm)	T (mm)	Ağırlık (kg/ad) Weight (kg/pcs)	Barkod Kodu Barcode Code
60 AGH 100TT	100	1.20 mm	0,495	2001814
60 AGH 160TT	160	1.20 mm	0,620	2001815
60 AGH 200TT	200	1.20 mm	0,840	2001816
60 AGH 300TT	300	1.20 mm	1,371	2001817
60 AGH 400TT	400	1.50 mm	3,029	2001818
60 AGH 500TT	500	1.50 mm	4,280	2001819
60 AGH 600TT	600	1.50 mm	5,783	2001820

H100

Sipariş Kodu Order Code	W (mm)	T (mm)	Ağırlık (kg/ad) Weight (kg/pcs)	Barkod Kodu Barcode Code
100 AGH 100TT	100	1.20 mm	0,736	2001821
100 AGH 160TT	160	1.20 mm	0,861	2001822
100 AGH 200TT	200	1.20 mm	1,121	2001823
100 AGH 300TT	300	1.20 mm	1,688	2001824
100 AGH 400TT	400	1.50 mm	3,371	2001825
100 AGH 500TT	500	1.50 mm	4,673	2001826
100 AGH 600TT	600	1.50 mm	6,233	2001827

H = YÜKSEKLİK = HEIGHT / W = GENİŞLİK = WIDTH / T = KALINLIK = THICKNESS

H AGH 100 TT

Yükseklik Kanal Tipi Genişlik Modül
Height Type Width Module

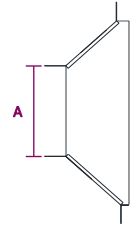
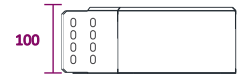

ARTIM METAL ELEKTRİK A.Ş.

- * Farklı kalınlık ve ölçülerde üretim yapılabılır.
- * Malzeme ağırlıkları yaklaşık değerlerdir, \pm %10 değişiklik gösterebilir.
- * Malzeme kalınlık toleransı \pm %10 dur.
- * Lütfen siparişlerinizde sipariş kodu veya ürün kodu ve Kaplama şeklini belirtiniz.

- * We can produce cable trays different thickness and dimensions
- * Cable trays are shown approximately weight, they could change \pm %10 difference.
- * Cable trays thickness tolerances are shown \pm %10 .
- * Please indicate order code and coating type in your orders.

AGH SERIES

YARIM T BAĞLANTI

ADD-ON TEES

SICAK DALDIRMA (SD)

HOT DIP GALVANIZED (SD)

TS EN ISO 1461

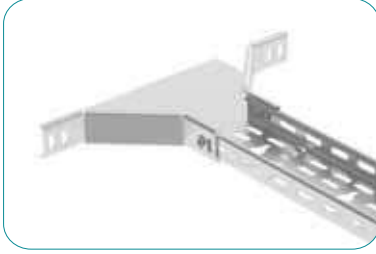

H40

Sipariş Kodu Order Code	W (mm)	T (mm)	Ağırlık (kg/ad) Weight (kg/pcs)	Barkod Kodu Barcode Code
40 AGH 100TT	100	1.50 mm	0,558	2001800
40 AGH 160TT	160	1.50 mm	0,747	2001801
40 AGH 200TT	200	1.50 mm	1,038	2001802
40 AGH 300TT	300	1.50 mm	1,781	2001803
40 AGH 400TT	400	2.00 mm	5,539	2001804
40 AGH 500TT	500	2.00 mm	5,669	2001805
40 AGH 600TT	600	2.00 mm	7,721	2001806

H50

Sipariş Kodu Order Code	W (mm)	T (mm)	Ağırlık (kg/ad) Weight (kg/pcs)	Barkod Kodu Barcode Code
50 AGH 100TT	100	1.50 mm	0,656	2001807
50 AGH 160TT	160	1.50 mm	0,840	2001808
50 AGH 200TT	200	1.50 mm	1,156	2001809
50 AGH 300TT	300	1.50 mm	1,903	2001810
50 AGH 400TT	400	2.00 mm	4,128	2001811
50 AGH 500TT	500	2.00 mm	5,861	2001812
50 AGH 600TT	600	2.00 mm	7,932	2001813

H60

Sipariş Kodu Order Code	W (mm)	T (mm)	Ağırlık (kg/ad) Weight (kg/pcs)	Barkod Kodu Barcode Code
60 AGH 100TT	100	1.50 mm	0,749	2001814
60 AGH 160TT	160	1.50 mm	0,933	2001815
60 AGH 200TT	200	1.50 mm	1,259	2001816
60 AGH 300TT	300	1.50 mm	2,021	2001817
60 AGH 400TT	400	2.00 mm	4,314	2001818
60 AGH 500TT	500	2.00 mm	6,057	2001819
60 AGH 600TT	600	2.00 mm	8,143	2001820

H100

Sipariş Kodu Order Code	W (mm)	T (mm)	Ağırlık (kg/ad) Weight (kg/pcs)	Barkod Kodu Barcode Code
100 AGH 100TT	100	1.50 mm	0,952	2001821
100 AGH 160TT	160	1.50 mm	1,136	2001822
100 AGH 200TT	200	1.50 mm	1,515	2001823
100 AGH 300TT	300	1.50 mm	2,326	2001824
100 AGH 400TT	400	2.00 mm	4,825	2001825
100 AGH 500TT	500	2.00 mm	6,641	2001826
100 AGH 600TT	600	2.00 mm	8,801	2001827

H = YÜKSEKLİK = HEIGHT / W = GENİŞLİK = WIDTH / T = KALINLIK = THICKNESS

H AGH 100 TT

Yükseklik Kanal Tipi Genişlik Modül
Height Type Width Module

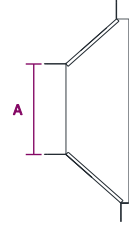
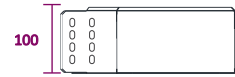

* Farklı kalınlık ve ölçülerde üretim yapılabılır.
* Malzeme ağırlıkları yaklaşık değerlerdir, \pm %10 değişiklik gösterebilir.
* Malzeme kalınlık toleransı \pm %10 dur.
* Lütfen siparişlerinizde sipariş kodu veya ürün kodu ve kaplama şeklini belirtiniz.

* We can produce cable trays different thickness and dimensions
* Cable trays are shown approximately weight, they could change \pm %10 difference.
* Cable trays thickness tolerances are shown \pm %10 .
* Please indicate order code and coating type in your orders.

AGH SERIES

REDÜKSİYON (PARÇALI)

REDUCING ANGLES (PIECE)

PREGALVANIZ (PG)
PREGALVANIZED (PG)
TS EN 10346



H40

Sipariş Kodu Order Code	W (mm)	T (mm)	Ağırlık (kg/ad) Weight (kg/pcs)	Barkod Kodu Barcode Code
40 AGH 050R	50	1.50 mm	0,175	2001400
40 AGH 100R	100	1.50 mm	0,215	2001401
40 AGH 150R	150	1.50 mm	0,250	2001402
40 AGH 200R	200	1.50 mm	0,285	2001403
40 AGH 300R	300	1.50 mm	0,360	2001404

H50

Sipariş Kodu Order Code	W (mm)	T (mm)	Ağırlık (kg/ad) Weight (kg/pcs)	Barkod Kodu Barcode Code
50 AGH 050R	50	1.50 mm	0,205	2001405
50 AGH 100R	100	1.50 mm	0,250	2001406
50 AGH 150R	150	1.50 mm	0,290	2001407
50 AGH 200R	200	1.50 mm	0,335	2001408
50 AGH 300R	300	1.50 mm	0,420	2001409

H60

Sipariş Kodu Order Code	W (mm)	T (mm)	Ağırlık (kg/ad) Weight (kg/pcs)	Barkod Kodu Barcode Code
60 AGH 050R	50	1.50 mm	0,235	2001410
60 AGH 100R	100	1.50 mm	0,285	2001411
60 AGH 150R	150	1.50 mm	0,335	2001412
60 AGH 200R	200	1.50 mm	0,380	2001413
60 AGH 300R	300	1.50 mm	0,480	2001414

H100

Sipariş Kodu Order Code	W (mm)	T (mm)	Ağırlık (kg/ad) Weight (kg/pcs)	Barkod Kodu Barcode Code
100 AGH 050R	50	1.50 mm	0,345	2001415
100 AGH 100R	100	1.50 mm	0,420	2001416
100 AGH 150R	150	1.50 mm	0,490	2001417
100 AGH 200R	200	1.50 mm	0,565	2001418
100 AGH 300R	300	1.50 mm	0,710	2001419

H = YÜKSEKLİK = HEIGHT / W = GENİŞLİK = WIDTH / T = KALINLIK = THICKNESS

H AGH 100 R

Yükseklik | Kanal Tipi | Genişlik | Modül
Height | Type | Width | Module

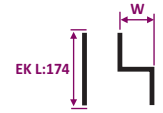

SOLA / LEFT

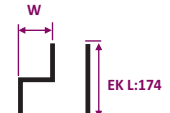

SAĞA / RIGHT

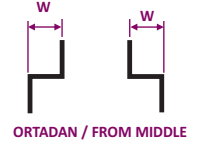

ORTADAN / FROM MIDDLE



Ürün tek olarak satılmaktadır.
The product is sold single.

ARTIM METAL ELEKTRİK A.Ş.

- * Farklı kalınlık ve ölçülerde üretim yapılabılır.
- * Malzeme ağırlıkları yaklaşık değerlerdir, \pm %10 değişiklik gösterebilir.
- * Malzeme kalınlık toleransı \pm %10 dur.
- * Lütfen siparişlerinizde sipariş kodu veya ürün kodu ve Kaplama şeklini belirtiniz.

- * We can produce cable trays different thickness and dimensions
- * Cable trays are shown approximately weight, they could change \pm %10 difference.
- * Cable trays thickness tolerances are shown \pm %10 .
- * Please indicate order code and coating type in your orders.

AGH SERIES

REDÜKSİYON (PARÇALI)

REDUCING ANGLES (PIECE)

SICAK DALDIRMA (SD)

HOT DIP GALVANIZED (SD)

TS EN ISO 1461



H40

Sipariş Kodu Order Code	W (mm)	T (mm)	Ağırlık (kg/ad) Weight (kg/pcs)	Barkod Kodu Barcode Code
40 AGH 050R	50	1.50 mm	0,195	2001400
40 AGH 100R	100	1.50 mm	0,240	2001401
40 AGH 150R	150	1.50 mm	0,275	2001402
40 AGH 200R	200	1.50 mm	0,315	2001403
40 AGH 300R	300	1.50 mm	0,395	2001404

H50

Sipariş Kodu Order Code	W (mm)	T (mm)	Ağırlık (kg/ad) Weight (kg/pcs)	Barkod Kodu Barcode Code
50 AGH 050R	50	1.50 mm	0,225	2001405
50 AGH 100R	100	1.50 mm	0,275	2001406
50 AGH 150R	150	1.50 mm	0,320	2001407
50 AGH 200R	200	1.50 mm	0,370	2001408
50 AGH 300R	300	1.50 mm	0,435	2001409

H60

Sipariş Kodu Order Code	W (mm)	T (mm)	Ağırlık (kg/ad) Weight (kg/pcs)	Barkod Kodu Barcode Code
60 AGH 050R	50	1.50 mm	0,260	2001410
60 AGH 100R	100	1.50 mm	0,315	2001411
60 AGH 150R	150	1.50 mm	0,370	2001412
60 AGH 200R	200	1.50 mm	0,420	2001413
60 AGH 300R	300	1.50 mm	0,525	2001414

H100

Sipariş Kodu Order Code	W (mm)	T (mm)	Ağırlık (kg/ad) Weight (kg/pcs)	Barkod Kodu Barcode Code
100 AGH 050R	50	1.50 mm	0,380	2001415
100 AGH 100R	100	1.50 mm	0,465	2001416
100 AGH 150R	150	1.50 mm	0,540	2001417
100 AGH 200R	200	1.50 mm	0,625	2001418
100 AGH 300R	300	1.50 mm	0,785	2001419

H = YÜKSEKLİK = HEIGHT / W = GENİŞLİK = WIDTH / T = KALINLIK = THICKNESS

H AGH 100 R

Yükseklik Height	Kanal Tipi Type	Genişlik Width	Modül Module
---------------------	--------------------	-------------------	-----------------

H40 + 5	65 mm	0 0	0 0
---------	-------	-----	-----

H50 + 5	0 0	0 0	0 0
---------	-----	-----	-----

H60 + 5	0 0	0 0	0 0
---------	-----	-----	-----

H100 + 5	0 0	0 0	0 0
----------	-----	-----	-----

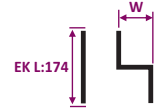

SOLA / LEFT

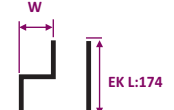

SAĞA / RIGHT

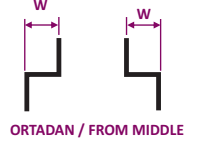

ORTADAN / FROM MIDDLE



Ürün tek olarak satılmaktadır.
The product is sold single.

* Farklı kalınlık ve ölçülerde üretim yapılabılır.
* Malzeme ağırlıkları yaklaşık değerlerdir, ± %10 değişiklik gösterebilir.
* Malzeme kalınlık toleransı ± %10 dur.
* Lütfen siparişlerinizde sipariş kodu veya ürün kodu ve Kaplama şeklini belirtiniz.

* We can produce cable trays different thickness and dimensions
* Cable trays are shown approximately weight, they could change ± %10 difference.
* Cable trays thickness tolerances are shown ± %10 .
* Please indicate order code and coating type in your orders.

AGH SERIES

İÇ-DİS BÜKEY DÖNÜS (HAREKETLİ)

ADJUSTABLE INSIDE-OUTSIDE VERTICAL BENDS

PREGALVANİZ (PG)
PREGALVANİZED (PG)
TS EN 10346



H40 = H50 Tek delikli
H40 = H50 One hole

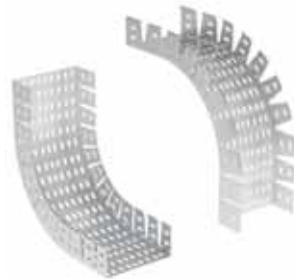

H40

Sipariş Kodu Order Code	W (mm)	T (mm)	Ağırlık (kg/ad) Weight (kg/pcs)	Barkod Kodu Barcode Code
40 AGH 050B	50	1.50 mm	0,950	2001559
40 AGH 100B	100	1.50 mm	1,295	2001560
40 AGH 120B	120	1.50 mm	1,432	2001614
40 AGH 160B	160	1.50 mm	1,570	2001561
40 AGH 200B	200	1.50 mm	1,955	2001562
40 AGH 300B	300	1.50 mm	2,615	2001563
40 AGH 400B	400	2.00 mm	4,580	2001564
40 AGH 500B	500	2.00 mm	5,510	2001565
40 AGH 600B	600	2.00 mm	6,440	2001566

H50

Sipariş Kodu Order Code	W (mm)	T (mm)	Ağırlık (kg/ad) Weight (kg/pcs)	Barkod Kodu Barcode Code
50 AGH 050B	50	1.50 mm	1,070	2001575
50 AGH 100B	100	1.50 mm	1,420	2001576
50 AGH 160B	160	1.50 mm	1,895	2001577
50 AGH 200B	200	1.50 mm	2,075	2001578
50 AGH 300B	300	1.50 mm	2,735	2001579
50 AGH 400B	400	2.00 mm	4,745	2001580
50 AGH 500B	500	2.00 mm	5,670	2001581
50 AGH 600B	600	2.00 mm	6,600	2001582

H60

Sipariş Kodu Order Code	W (mm)	T (mm)	Ağırlık (kg/ad) Weight (kg/pcs)	Barkod Kodu Barcode Code
60 AGH 100B	100	1.50 mm	1,480	2001583
60 AGH 160B	160	1.50 mm	1,965	2001584
60 AGH 200B	200	1.50 mm	2,140	2001585
60 AGH 300B	300	2.00 mm	2,800	2001586
60 AGH 400B	400	2.00 mm	4,895	2001587
60 AGH 500B	500	2.00 mm	5,825	2001588
60 AGH 600B	600	2.00 mm	6,755	2001589

H100

Sipariş Kodu Order Code	W (mm)	T (mm)	Ağırlık (kg/ad) Weight (kg/pcs)	Barkod Kodu Barcode Code
100 AGH 100B	100	1.50 mm	1,825	2001590
100 AGH 160B	160	1.50 mm	2,305	2001591
100 AGH 200B	200	1.50 mm	2,485	2001592
100 AGH 300B	300	2.00 mm	3,145	2001593
100 AGH 400B	400	2.00 mm	5,350	2001594
100 AGH 500B	500	2.00 mm	6,280	2001595
100 AGH 600B	600	2.00 mm	7,210	2001596

H = YÜKSEKLİK = HEIGHT / W = GENİŞLİK = WIDTH / T = KALINLIK = THICKNESS

H AGH 100 B

Yükseklik Kanal Tipi Genişlik Modül
Height Type Width Module

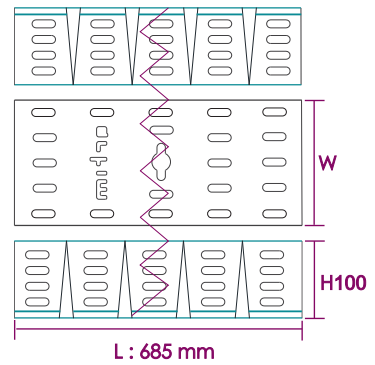
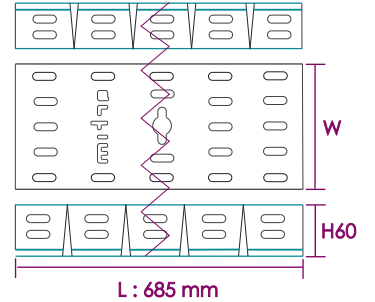
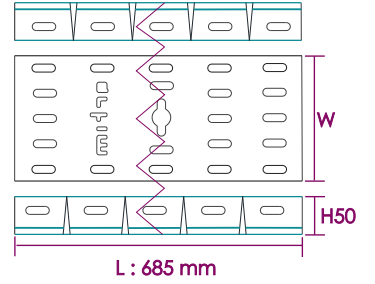
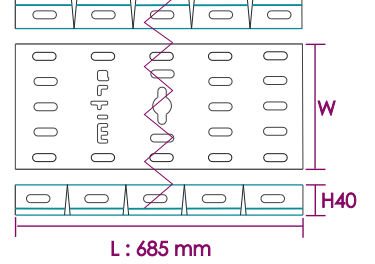

ARTIM METAL ELEKTRİK A.Ş.

* Farklı kalınlık ve ölçülerde üretim yapılabılır.
* Malzeme ağırlıkları yaklaşık değerlerdir, ± %10 değişiklik gösterebilir.
* Malzeme kalınlık toleransı ± %10 dur.
* Lütfen siparişlerinizde sipariş kodu veya ürün kodu ve Kaplama şeklini belirtiniz.

* We can produce cable trays different thickness and dimensions
* Cable trays are shown approximately weight, they could change ± %10 difference.
* Cable trays thickness tolerances are shown ± %10 .
* Please indicate order code and coating type in your orders.

AGH SERIES

İÇ-DİS BÜKEY DÖNÜS (HAREKETLİ)

ADJUSTABLE INSIDE-OUTSIDE VERTICAL BENDS

SICAK DALDIRMA (SD)

HOT DIP GALVANIZED (HDG)

TS EN ISO 1461



H40 = H50 Tek delikli
H40 = H50 One hole

H40

Sipariş Kodu Order Code	W (mm)	T (mm)	Ağırlık (kg/ad) Weight (kg/pcs)	Barkod Kodu Barcode Code
40 AGH 050B	50	1.50 mm	1,045	2001559
40 AGH 100B	100	1.50 mm	0,789	2001560
40 AGH 120B	120	1.50 mm	0,900	2001614
40 AGH 160B	160	1.50 mm	1,010	2001561
40 AGH 200B	200	1.50 mm	1,367	2001562
40 AGH 300B	300	1.50 mm	2,183	2001563
40 AGH 400B	400	2.00 mm	5,715	2001564
40 AGH 500B	500	2.00 mm	5,980	2001565
40 AGH 600B	600	2.00 mm	7,973	2001566

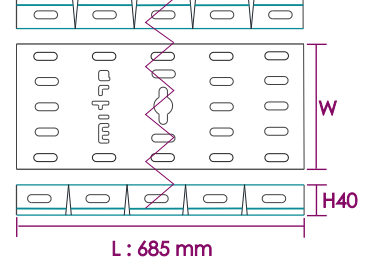
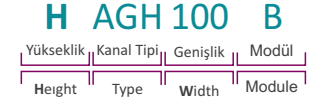

H50

Sipariş Kodu Order Code	W (mm)	T (mm)	Ağırlık (kg/ad) Weight (kg/pcs)	Barkod Kodu Barcode Code
50 AGH 050B	50	1.50 mm	1,175	2001575
50 AGH 100B	100	1.50 mm	1,555	2001576
50 AGH 160B	160	1.50 mm	2,085	2001577
50 AGH 200B	200	1.50 mm	2,280	2001578
50 AGH 300B	300	1.50 mm	3,005	2001579
50 AGH 400B	400	2.00 mm	5,215	2001580
50 AGH 500B	500	2.00 mm	6,240	2001581
50 AGH 600B	600	2.00 mm	7,260	2001582

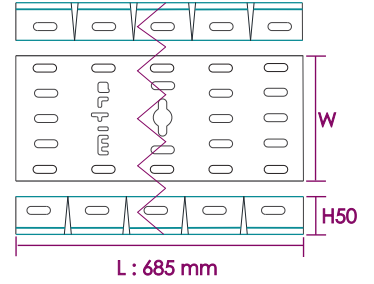

H60

Sipariş Kodu Order Code	W (mm)	T (mm)	Ağırlık (kg/ad) Weight (kg/pcs)	Barkod Kodu Barcode Code
60 AGH 100B	100	1.50 mm	1,630	2001583
60 AGH 160B	160	1.50 mm	2,160	2001584
60 AGH 200B	200	1.50 mm	2,355	2001585
60 AGH 300B	300	1.50 mm	3,080	2001586
60 AGH 400B	400	2.00 mm	5,385	2001587
60 AGH 500B	500	2.00 mm	6,410	2001588
60 AGH 600B	600	2.00 mm	7,430	2001589

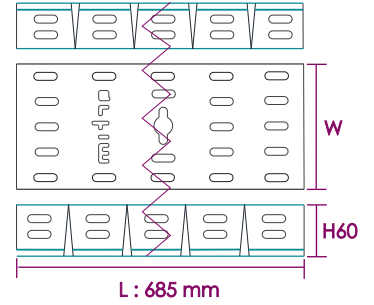

H100

Sipariş Kodu Order Code	W (mm)	T (mm)	Ağırlık (kg/ad) Weight (kg/pcs)	Barkod Kodu Barcode Code
100 AGH 100B	100	1.50 mm	2,000	2001590
100 AGH 160B	160	1.50 mm	2,540	2001591
100 AGH 200B	200	1.50 mm	2,730	2001592
100 AGH 300B	300	1.50 mm	3,460	2001593
100 AGH 400B	400	2.00 mm	5,885	2001594
100 AGH 500B	500	2.00 mm	6,905	2001595
100 AGH 600B	600	2.00 mm	7,930	2001596

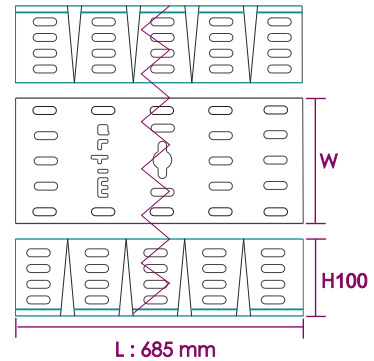

H = YÜKSEKLİK = HEIGHT / W = GENİŞLİK = WIDTH / T = KALINLIK = THICKNESS



* Farklı kalınlık ve ölçülerde üretim yapıla bilinir.
* Malzeme ağırlıkları yaklaşık değerlerdir, \pm %10 değişiklik gösterebilir.
* Malzeme kalınlık toleransı \pm %10 dur.
* Lütfen siparişlerinizde sipariş kodu veya ürün kodu ve kaplama şeklini belirtiniz.

* We can produce cable trays different thickness and dimensions
* Cable trays are shown approximately weight, they could change \pm %10 difference.
* Cable trays thickness tolerances are shown \pm %10 .
* Please indicate order code and coating type in your orders.

AST SERIES

İÇ-DİS BÜKEY DÖNÜS (HAREKETLİ)

ADJUSTABLE INSIDE-OUTSIDE VERTICAL BENDS

PREGALVANİZ (PG)
PREGALVANİZ (PG)
TS EN 10346



H40 = H50 Tek delikli
H40 = H50 One hole

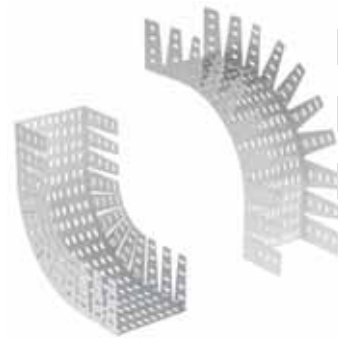

ARTİM METAL ELEKTRİK A.Ş.

H40

Sipariş Kodu Order Code	W (mm)	T (mm)	Ağırlık (kg/ad) Weight (kg/pcs)	Barkod Kodu Barcode Code
40 AST 050B	50	1.50 mm	0,825	2001550
40 AST 100B	100	1.50 mm	1,170	2001551
40 AST 120B	120	1.50 mm	1,300	2001552
40 AST 160B	160	1.50 mm	1,495	2001553
40 AST 200B	200	1.50 mm	1,830	2001554
40 AST 300B	300	1.50 mm	2,490	2001555
40 AST 400B	400	2.00 mm	4,410	2001556
40 AST 500B	500	2.00 mm	5,335	2001557
40 AST 600B	600	2.00 mm	6,265	2001558

H50

Sipariş Kodu Order Code	W (mm)	T (mm)	Ağırlık (kg/ad) Weight (kg/pcs)	Barkod Kodu Barcode Code
50 AST 050B	50	1.50 mm	0,950	2001567
50 AST 100B	100	1.50 mm	1,295	2001568
50 AST 160B	160	1.50 mm	1,485	2001569
50 AST 200B	200	1.50 mm	1,955	2001570
50 AST 300B	300	1.50 mm	2,615	2001571
50 AST 400B	400	2.00 mm	4,580	2001572
50 AST 500B	500	2.00 mm	5,510	2001573
50 AST 600B	600	2.00 mm	6,440	2001574

H60

Sipariş Kodu Order Code	W (mm)	T (mm)	Ağırlık (kg/ad) Weight (kg/pcs)	Barkod Kodu Barcode Code
60 AST 100B	100	1.50 mm	1,480	2001597
60 AST 160B	160	1.50 mm	1,965	2001599
60 AST 200B	200	1.50 mm	2,140	2001600
60 AST 300B	300	2.00 mm	2,800	2001601
60 AST 400B	400	2.00 mm	4,895	2001602
60 AST 500B	500	2.00 mm	5,825	2001603
60 AST 600B	600	2.00 mm	6,755	2001604

H100

Sipariş Kodu Order Code	W (mm)	T (mm)	Ağırlık (kg/ad) Weight (kg/pcs)	Barkod Kodu Barcode Code
100 AST 100B	100	1.50 mm	1,825	2001605
100 AST 160B	160	1.50 mm	2,305	2001607
100 AST 200B	200	1.50 mm	2,485	2001608
100 AST 300B	300	2.00 mm	3,145	2001609
100 AST 400B	400	2.00 mm	5,350	2001610
100 AST 500B	500	2.00 mm	6,280	2001611
100 AST 600B	600	2.00 mm	7,210	2001612

H = YÜKSEKLİK = HEIGHT / W = GENİŞLİK = WIDTH / T = KALINLIK = THICKNESS

H AST 100 B

Yükseklik Kanal Tipi Genişlik Modül
Height Type Width Module

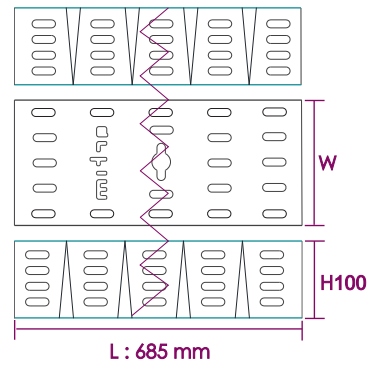
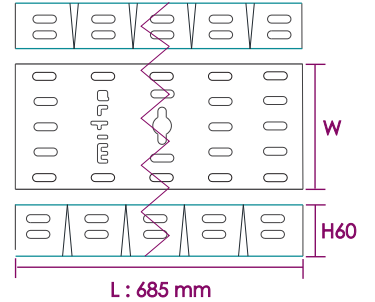
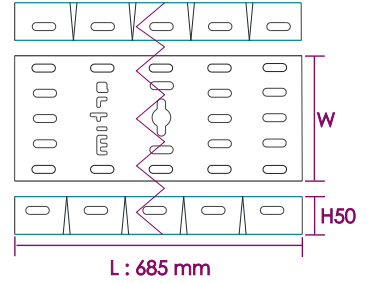
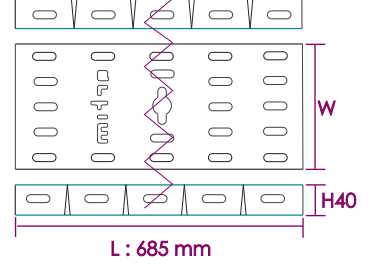

* Farklı kalınlık ve ölçülerde üretim yapılabılır.
* Malzeme ağırlıkları yaklaşık değerlerdir, ± %10 değişiklik gösterebilir.
* Malzeme kalınlık toleransı ± %10 dur.
* Lütfen siparişlerinizde sipariş kodu veya ürün kodu ve Kaplama şeklini belirtiniz.

* We can produce cable trays different thickness and dimensions
* Cable trays are shown approximately weight, they could change ± %10 difference.
* Cable trays thickness tolerances are shown ± %10 .
* Please indicate order code and coating type in your orders.

AST SERIES

İÇ-DİS BÜKEY DÖNÜS (HAREKETLİ)

ADJUSTABLE INSIDE-OUTSIDE VERTICAL BENDS

SICAK DALDIRMA (SD)

HOT DIP GALVANIZED (HDG)

TS EN ISO 1461



H40 = H50 Tek delikli

H40 = H50 One hole

H40

Sipariş Kodu Order Code	W (mm)	T (mm)	Ağırlık (kg/ad) Weight (kg/pcs)	Barkod Kodu Barcode Code
40 AST 050B	50	1.50 mm	0,905	2001550
40 AST 100B	100	1.50 mm	1,285	2001551
40 AST 120B	120	1.50 mm	1,430	2001552
40 AST 160B	160	1.50 mm	1,645	2001553
40 AST 200B	200	1.50 mm	2,010	2001554
40 AST 300B	300	1.50 mm	2,740	2001555
40 AST 400B	400	2.00 mm	4,850	2001556
40 AST 500B	500	2.00 mm	5,870	2001557
40 AST 600B	600	2.00 mm	6,895	2001558

H50

Sipariş Kodu Order Code	W (mm)	T (mm)	Ağırlık (kg/ad) Weight (kg/pcs)	Barkod Kodu Barcode Code
50 AST 050B	50	1.50 mm	1,045	2001567
50 AST 100B	100	1.50 mm	1,425	2001568
50 AST 160B	160	1.50 mm	1,635	2001569
50 AST 200B	200	1.50 mm	2,150	2001570
50 AST 300B	300	1.50 mm	2,875	2001571
50 AST 400B	400	2.00 mm	5,040	2001572
50 AST 500B	500	2.00 mm	6,060	2001573
50 AST 600B	600	2.00 mm	7,080	2001574

H60

Sipariş Kodu Order Code	W (mm)	T (mm)	Ağırlık (kg/ad) Weight (kg/pcs)	Barkod Kodu Barcode Code
60 AST 100B	100	1.50 mm	1,630	2001597
60 AST 160B	160	1.50 mm	2,160	2001599
60 AST 200B	200	1.50 mm	2,355	2001600
60 AST 300B	300	1.50 mm	3,080	2001601
60 AST 400B	400	2.00 mm	5,385	2001602
60 AST 500B	500	2.00 mm	6,410	2001603
60 AST 600B	600	2.00 mm	7,430	2001604

H100

Sipariş Kodu Order Code	W (mm)	T (mm)	Ağırlık (kg/ad) Weight (kg/pcs)	Barkod Kodu Barcode Code
100 AST 100B	100	1.50 mm	2,000	2001605
100 AST 160B	160	1.50 mm	2,540	2001607
100 AST 200B	200	1.50 mm	2,730	2001608
100 AST 300B	300	1.50 mm	3,460	2001609
100 AST 400B	400	2.00 mm	5,885	2001610
100 AST 500B	500	2.00 mm	6,905	2001611
100 AST 600B	600	2.00 mm	7,930	2001612

H = YÜKSEKLİK = HEIGHT / W = GENİŞLİK = WIDTH / T = KALINLIK = THICKNESS

H AST 100 B

Yükseklik Kanal Tipi Genişlik Modül
Height Type Width Module

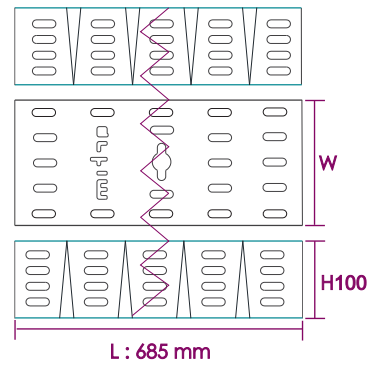
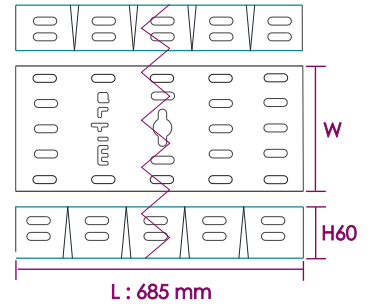
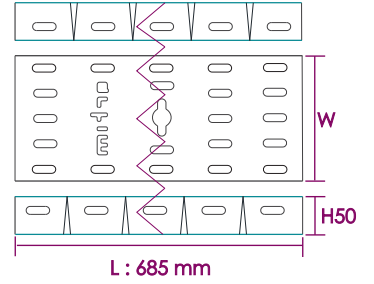
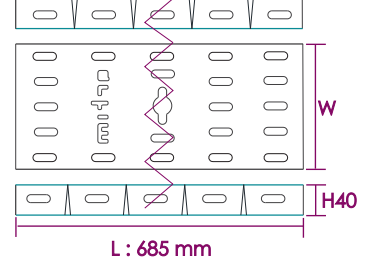

* Farklı kalınlık ve ölçülerde üretim yapılabılır.
* Malzeme ağırlıkları yaklaşık değerlerdir, ± %10 değişiklik gösterebilir.
* Malzeme kalınlık toleransı ± %10 dur.
* Lütfen siparişlerinizde sipariş kodu veya ürün kodu ve kaplama şeklini belirtiniz.

* We can produce cable trays different thickness and dimensions
* Cable trays are shown approximately weight, they could change ± %10 difference.
* Cable trays thickness tolerances are shown ± %10 .
* Please indicate order code and coating type in your orders.

AST SERIES

İÇ BÜKEY DÖNÜS (SABIT)

CONSTANT INSIDE VERTICAL BENDS

PREGALVANİZ (PG)
PREGALVANİZ (PG)
TS EN 10346



H40 = H50 Tek delikli
H40 = H50 One hole



H40

Sipariş Kodu Order Code	W (mm)	T (mm)	Ağırlık (kg/ad) Weight (kg/pcs)	Barkod Kodu Barcode Code
40 AST 050B S1	50	1.50 mm	1,135	2001500
40 AST 100B S1	100	1.50 mm	1,475	2001501
40 AST 120B S1	120	1.50 mm	1,615	2001502
40 AST 160B S1	160	1.50 mm	1,880	2001503
40 AST 200B S1	200	1.50 mm	2,165	2001504
40 AST 300B S1	300	1.50 mm	2,860	2001505
40 AST 400B S1	400	2.00 mm	4,720	2001506
40 AST 500B S1	500	2.00 mm	5,650	2001507
40 AST 600B S1	600	2.00 mm	6,570	2001508

H50

Sipariş Kodu Order Code	W (mm)	T (mm)	Ağırlık (kg/ad) Weight (kg/pcs)	Barkod Kodu Barcode Code
50 AST 050B S1	50	1.50 mm	1,235	2001509
50 AST 100B S1	100	1.50 mm	1,575	2001510
50 AST 160B S1	160	1.50 mm	1,975	2001512
50 AST 200B S1	200	1.50 mm	2,265	2001513
50 AST 300B S1	300	1.50 mm	2,960	2001514
50 AST 400B S1	400	2.00 mm	4,875	2001515
50 AST 500B S1	500	2.00 mm	5,650	2001516
50 AST 600B S1	600	2.00 mm	6,715	2001517

H60

Sipariş Kodu Order Code	W (mm)	T (mm)	Ağırlık (kg/ad) Weight (kg/pcs)	Barkod Kodu Barcode Code
60 AST 100B S1	100	1.50 mm	1,685	2001518
60 AST 160B S1	160	1.50 mm	2,085	2001520
60 AST 200B S1	200	1.50 mm	2,370	2001521
60 AST 300B S1	300	2.00 mm	3,065	2001522
60 AST 400B S1	400	2.00 mm	5,015	2001523
60 AST 500B S1	500	2.00 mm	5,935	2001524
60 AST 600B S1	600	2.00 mm	6,855	2001525

H100

Sipariş Kodu Order Code	W (mm)	T (mm)	Ağırlık (kg/ad) Weight (kg/pcs)	Barkod Kodu Barcode Code
100 AST 100B S1	100	1.50 mm	2,050	2001526
100 AST 160B S1	160	1.50 mm	2,455	2001528
100 AST 200B S1	200	1.50 mm	2,745	2001529
100 AST 300B S1	300	2.00 mm	3,435	2001530
100 AST 400B S1	400	2.00 mm	5,500	2001531
100 AST 500B S1	500	2.00 mm	6,420	2001532
100 AST 600B S1	600	2.00 mm	7,340	2001533

H = YÜKSEKLİK = HEIGHT / W = GENİŞLİK = WIDTH / T = KALINLIK = THICKNESS

H AST 100 B S1

Yükseklik Kanal Tipi Genişlik Modül
Height Type Width Module

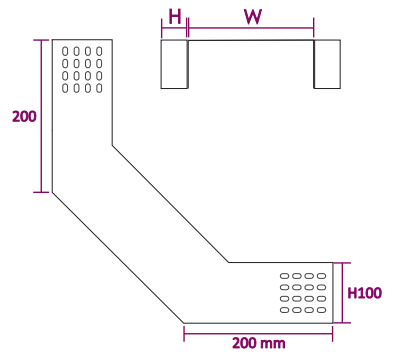
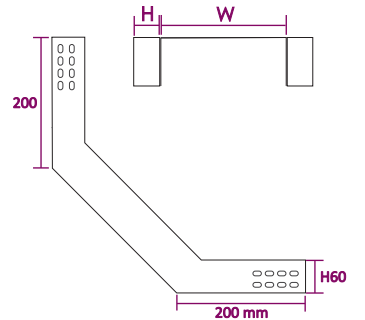
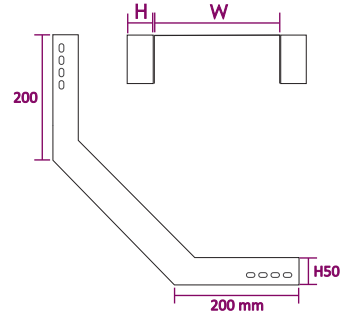
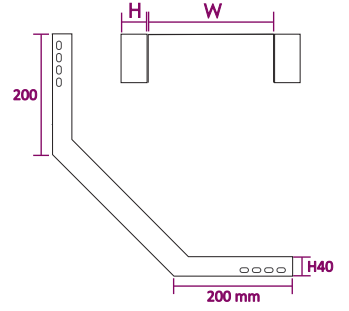

ARTIM METAL ELEKTRİK A.Ş.

* Farklı kalınlık ve ölçülerde üretim yapılabılır.
* Malzeme ağırlıkları yaklaşık değerlerdir, ± %10 değişiklik gösterebilir.
* Malzeme kalınlık toleransı ± %10 dur.
* Lütfen siparişlerinizde sipariş kodu veya ürün kodu ve Kaplama şeklini belirtiniz.

* We can produce cable trays different thickness and dimensions
* Cable trays are shown approximately weight, they could change ± %10 difference.
* Cable trays thickness tolerances are shown ± %10 .
* Please indicate order code and coating type in your orders.

AST SERIES

İÇ BÜKEY DÖNÜŞ (SABİT)

CONSTANT INSIDE VERTICAL BENDS

SICAK DALDIRMA (SD)

HOT DIP GALVANIZED (HDG)

TS EN ISO 1461



H40 = H50 Tek delikli
H40 = H50 One hole

H40

Sipariş Kodu Order Code	W (mm)	T (mm)	Ağırlık (kg/ad) Weight (kg/pcs)	Barkod Kodu Barcode Code
40 AST 050B S1	50	1.50 mm	1,245	2001500
40 AST 100B S1	100	1.50 mm	1,625	2001501
40 AST 120B S1	120	1.50 mm	1,775	2001502
40 AST 160B S1	160	1.50 mm	2,070	2001503
40 AST 200B S1	200	1.50 mm	3,145	2001504
40 AST 300B S1	300	1.50 mm	3,575	2001505
40 AST 400B S1	400	2.00 mm	5,195	2001506
40 AST 500B S1	500	2.00 mm	6,215	2001507
40 AST 600B S1	600	2.00 mm	7,230	2001508

H50

Sipariş Kodu Order Code	W (mm)	T (mm)	Ağırlık (kg/ad) Weight (kg/pcs)	Barkod Kodu Barcode Code
50 AST 050B S1	50	1.50 mm	1,355	2001509
50 AST 100B S1	100	1.50 mm	1,735	2001510
50 AST 160B S1	160	1.50 mm	2,175	2001512
50 AST 200B S1	200	1.50 mm	2,490	2001513
50 AST 300B S1	300	1.50 mm	3,255	2001514
50 AST 400B S1	400	2.00 mm	5,365	2001515
50 AST 500B S1	500	2.00 mm	6,215	2001516
50 AST 600B S1	600	2.00 mm	7,385	2001517

H60

Sipariş Kodu Order Code	W (mm)	T (mm)	Ağırlık (kg/ad) Weight (kg/pcs)	Barkod Kodu Barcode Code
60 AST 100B S1	100	1.50 mm	1,850	2001518
60 AST 160B S1	160	1.50 mm	2,295	2001520
60 AST 200B S1	200	1.50 mm	2,610	2001521
60 AST 300B S1	300	1.50 mm	3,370	2001522
60 AST 400B S1	400	2.00 mm	5,515	2001523
60 AST 500B S1	500	2.00 mm	6,530	2001524
60 AST 600B S1	600	2.00 mm	7,540	2001525

H100

Sipariş Kodu Order Code	W (mm)	T (mm)	Ağırlık (kg/ad) Weight (kg/pcs)	Barkod Kodu Barcode Code
100 AST 100B S1	100	1.50 mm	2,255	2001526
100 AST 160B S1	160	1.50 mm	2,700	2001528
100 AST 200B S1	200	1.50 mm	3,020	2001529
100 AST 300B S1	300	1.50 mm	3,775	2001530
100 AST 400B S1	400	2.00 mm	6,050	2001531
100 AST 500B S1	500	2.00 mm	7,065	2001532
100 AST 600B S1	600	2.00 mm	8,075	2001533

H = YÜKSEKLİK = HEIGHT / W = GENİŞLİK = WIDTH / T = KALINLIK = THICKNESS

H AST 100 B S1

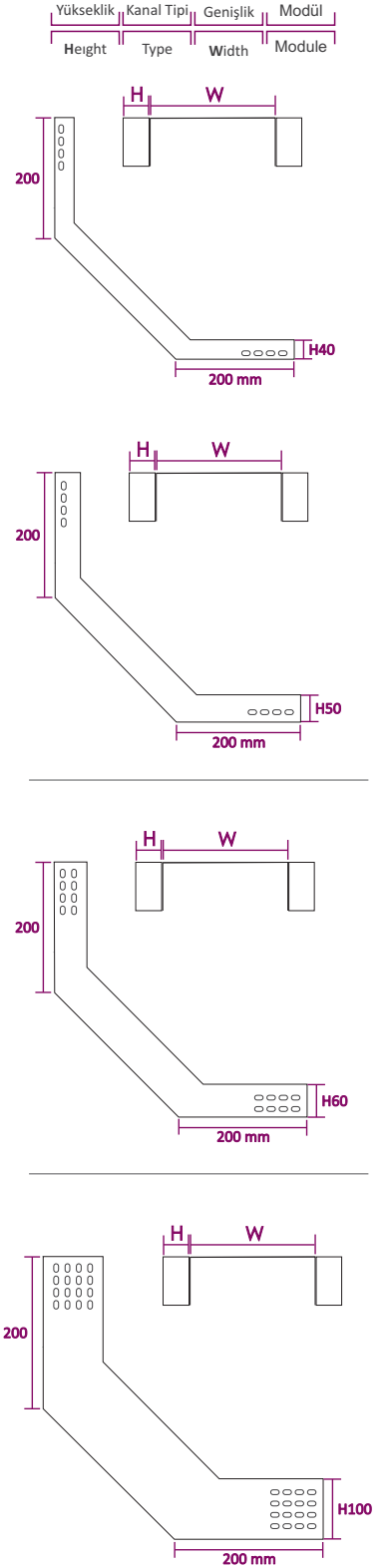

* Farklı kalınlık ve ölçülerde üretim yapılabılır.
* Malzeme ağırlıkları yaklaşık değerlerdir, ± %10 değişiklik gösterebilir.
* Malzeme kalınlık toleransı ± %10 dur.
* Lütfen siparişlerinizde sipariş kodu veya ürün kodu ve kaplama şeklini belirtiniz.

* We can produce cable trays different thickness and dimensions
* Cable trays are shown approximately weight, they could change ± %10 difference.
* Cable trays thickness tolerances are shown ± %10 .
* Please indicate order code and coating type in your orders.

AST SERIES

DIS BÜKEY DÖNÜS (SABIT)

CONSTANT OUTSIDE VERTICAL BENDS

PREGALVANIZ (PG)
PREGALVANIZED (PG)
TS EN 10346



H40 = H50 Tek delikli
H40 = H50 One hole



H40

Sipariş Kodu Order Code	W (mm)	T (mm)	Ağırlık (kg/ad) Weight (kg/pcs)	Barkod Kodu Barcode Code
40 AST 050B S2	50	1.50 mm	1,135	2001500
40 AST 100B S2	100	1.50 mm	1,475	2001501
40 AST 120B S2	120	1.50 mm	1,615	2001502
40 AST 160B S2	160	1.50 mm	1,880	2001503
40 AST 200B S2	200	1.50 mm	2,165	2001504
40 AST 300B S2	300	1.50 mm	2,860	2001505
40 AST 400B S2	400	2.00 mm	4,720	2001506
40 AST 500B S2	500	2.00 mm	5,650	2001507
40 AST 600B S2	600	2.00 mm	6,570	2001508

H50

Sipariş Kodu Order Code	W (mm)	T (mm)	Ağırlık (kg/ad) Weight (kg/pcs)	Barkod Kodu Barcode Code
50 AST 050B S2	50	1.50 mm	1,235	2001509
50 AST 100B S2	100	1.50 mm	1,575	2001510
50 AST 160B S2	160	1.50 mm	1,975	2001512
50 AST 200B S2	200	1.50 mm	2,265	2001513
50 AST 300B S2	300	1.50 mm	2,960	2001514
50 AST 400B S2	400	2.00 mm	4,875	2001515
50 AST 500B S2	500	2.00 mm	5,650	2001516
50 AST 600B S2	600	2.00 mm	6,715	2001517

H60

Sipariş Kodu Order Code	W (mm)	T (mm)	Ağırlık (kg/ad) Weight (kg/pcs)	Barkod Kodu Barcode Code
60 AST 100B S2	100	1.50 mm	1,685	2001518
60 AST 160B S2	160	1.50 mm	2,085	2001520
60 AST 200B S2	200	1.50 mm	2,370	2001521
60 AST 300B S2	300	2.00 mm	3,065	2001522
60 AST 400B S2	400	2.00 mm	5,015	2001523
60 AST 500B S2	500	2.00 mm	5,935	2001524
60 AST 600B S2	600	2.00 mm	6,855	2001525

H100

Sipariş Kodu Order Code	W (mm)	T (mm)	Ağırlık (kg/ad) Weight (kg/pcs)	Barkod Kodu Barcode Code
100 AST 100B S2	100	1.50 mm	2,050	2001526
100 AST 160B S2	160	1.50 mm	2,455	2001528
100 AST 200B S2	200	1.50 mm	2,745	2001529
100 AST 300B S2	300	2.00 mm	3,435	2001530
100 AST 400B S2	400	2.00 mm	5,500	2001531
100 AST 500B S2	500	2.00 mm	6,420	2001532
100 AST 600B S2	600	2.00 mm	7,340	2001533

H = YÜKSEKLİK = HEIGHT / W = GENİŞLİK = WIDTH / T = KALINLIK = THICKNESS

H AST 100 B S2

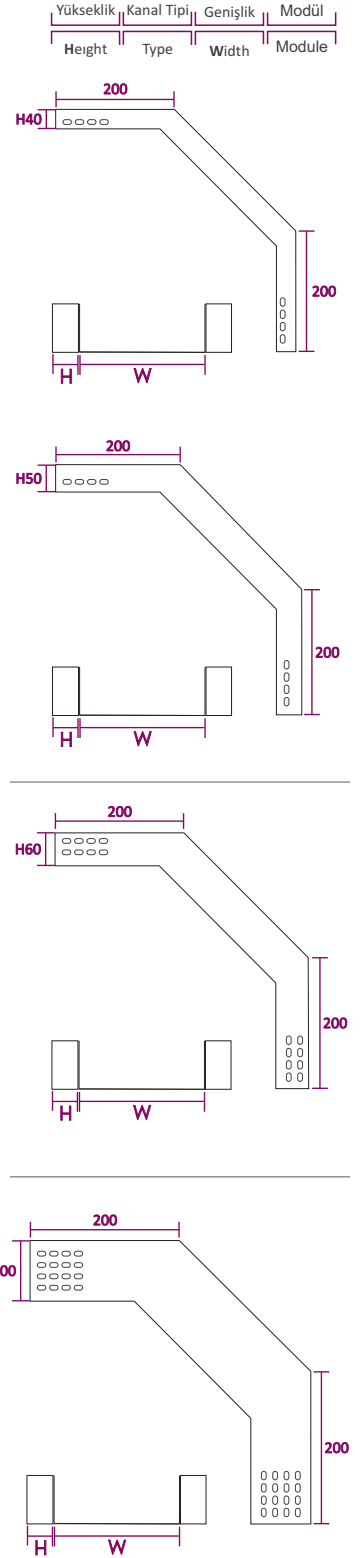

ARTIM METAL ELEKTRİK A.Ş.

* Farklı kalınlık ve ölçülerde üretim yapılabılır.
* Malzeme ağırlıkları yaklaşık değerlerdir, \pm %10 değişiklik gösterebilir.
* Malzeme kalınlık toleransı \pm %10 dur.
* Lütfen siparişlerinizde sipariş kodu veya ürün kodu ve Kaplama şeklini belirtiniz.

* We can produce cable trays different thickness and dimensions
* Cable trays are shown approximately weight, they could change \pm %10 difference.
* Cable trays thickness tolerances are shown \pm %10 .
* Please indicate order code and coating type in your orders.

AST SERIES

DIS BÜKEY DÖNÜS (SABIT)

CONSTANT OUTSIDE VERTICAL BENDS

SICAK DALDIRMA (SD)

HOT DIP GALVANIZED (HDG)

TS EN ISO 1461



H40 = H50 Tek delikli
H40 = H50 One hole

Sipariş Kodu Order Code	W (mm)	T (mm)	Ağırlık (kg/ad) Weight (kg/pcs)	Barkod Kodu Barcode Code
40 AST 050B S2	50	1.50 mm	1,245	2001500
40 AST 100B S2	100	1.50 mm	1,625	2001501
40 AST 120B S2	120	1.50 mm	1,775	2001502
40 AST 160B S2	160	1.50 mm	2,070	2001503
40 AST 200B S2	200	1.50 mm	3,145	2001504
40 AST 300B S2	300	1.50 mm	3,575	2001505
40 AST 400B S2	400	2.00 mm	5,195	2001506
40 AST 500B S2	500	2.00 mm	6,215	2001507
40 AST 600B S2	600	2.00 mm	7,230	2001508

Sipariş Kodu Order Code	W (mm)	T (mm)	Ağırlık (kg/ad) Weight (kg/pcs)	Barkod Kodu Barcode Code
50 AST 050B S2	50	1.50 mm	1,355	2001509
50 AST 100B S2	100	1.50 mm	1,735	2001510
50 AST 160B S2	160	1.50 mm	2,175	2001512
50 AST 200B S2	200	1.50 mm	2,490	2001513
50 AST 300B S2	300	1.50 mm	3,255	2001514
50 AST 400B S2	400	2.00 mm	5,365	2001515
50 AST 500B S2	500	2.00 mm	6,215	2001516
50 AST 600B S2	600	2.00 mm	7,385	2001517

Sipariş Kodu Order Code	W (mm)	T (mm)	Ağırlık (kg/ad) Weight (kg/pcs)	Barkod Kodu Barcode Code
60 AST 100B S2	100	1.50 mm	1,850	2001518
60 AST 160B S2	160	1.50 mm	2,295	2001520
60 AST 200B S2	200	1.50 mm	2,610	2001521
60 AST 300B S2	300	1.50 mm	3,370	2001522
60 AST 400B S2	400	2.00 mm	5,515	2001523
60 AST 500B S2	500	2.00 mm	6,530	2001524
60 AST 600B S2	600	2.00 mm	7,540	2001525

Sipariş Kodu Order Code	W (mm)	T (mm)	Ağırlık (kg/ad) Weight (kg/pcs)	Barkod Kodu Barcode Code
100 AST 100B S2	100	1.50 mm	2,255	2001526
100 AST 160B S2	160	1.50 mm	2,700	2001528
100 AST 200B S2	200	1.50 mm	3,020	2001529
100 AST 300B S2	300	1.50 mm	3,775	2001530
100 AST 400B S2	400	2.00 mm	6,050	2001531
100 AST 500B S2	500	2.00 mm	7,065	2001532
100 AST 600B S2	600	2.00 mm	8,075	2001533

H = YÜKSEKLİK = HEIGHT / W = GENİŞLİK = WIDTH / T = KALINLIK = THICKNESS

H AST 100 B S2

Yükseklik Kanal Tipi Genişlik Modül
Height Type Width Module

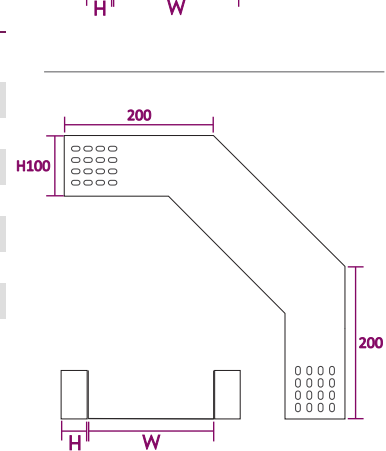
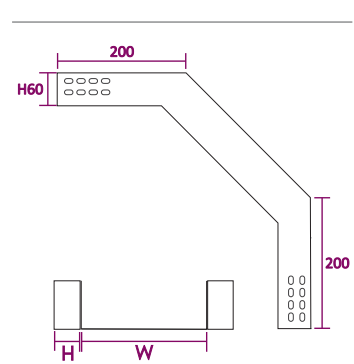
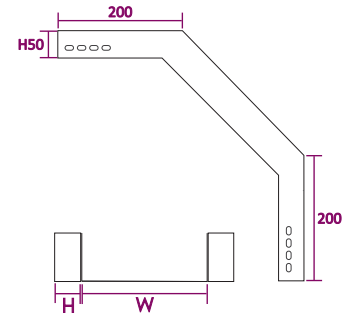
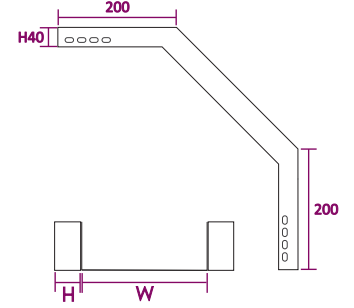

* Farklı kalınlık ve ölçülerde üretim yapıla bilinir.
* Malzeme ağırlıkları yaklaşık değerlerdir, ± %10 değişiklik gösterebilir.
* Malzeme kalınlık toleransı ± %10 dur.
* Lütfen siparişlerinizde sipariş kodu veya ürün kodu ve Kaplama şeklini belirtiniz.

* We can produce cable trays different thickness and dimensions
* Cable trays are shown approximately weight, they could change ± %10 difference.
* Cable trays thickness tolerances are shown ± %10 .
* Please indicate order code and coating type in your orders.

AGH SERIES

DIKEY & YATAY SEVIYE DEGİSTİRME

VERTICAL & HORIZONTAL ANGLE CONNECTOR

PREGALVANİZ (PG)
PREGALVANİZED (PG)
TS EN 10346



H40 = H50 Tek delikli
H40 = H50 One hole

H60 = Çift delikli
H60 = Double hole

H100 = Dört delikli
H100 = Four holes

Ürün tek parça satılmaktadır. 1 Takım için;
4 adet Seviye Degistirici, 4 adet M8x15 Civata,
4 adet Somun kullanılmaktadır.
The product is sold in one piece. For 1 Team;
4 Angle Connector, 4 M8x15 Bolts,
4 Nuts are used.

DİKEY & VERTICAL				
Sipariş Kodu Order Code	L (mm)	T (mm)	Ağırlık (kg/ad) Weight (kg/pcs)	Barkod Kodu Barcode Code
40 AGH 00 S	160	1.50 mm	0,096	2001600
50 AGH 00 S	160	1.50 mm	0,115	2001602
60 AGH 00 S	160	1.50 mm	0,135	2001604
100 AGH 00 S	160	1.50 mm	0,205	2001606



H AGH 00 S			
Yükseklik Height	Kanal Tipi Type	Genişlik Width	Modül Module

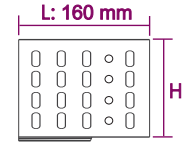
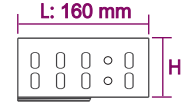

H40 = H50 Tek delikli
H40 = H50 One hole

H60 = Çift delikli
H60 = Double hole

H100 = Dört delikli
H100 = Four holes

Ürün tek parça satılmaktadır. 1 Takım için;
2 adet Seviye Degistirici, 4 adet M8x15 Civata,
4 adet Somun kullanılmaktadır.
The product is sold in one piece. For 1 Team;
4 Angle Connector, 4 M8x15 Bolts,
4 Nuts are used.

YATAY & HORIZONTAL				
Sipariş Kodu Order Code	L (mm)	T (mm)	Ağırlık (kg/ad) Weight (kg/pcs)	Barkod Kodu Barcode Code
40 AGH 01 S	230	1.50 mm	0,096	2001601
50 AGH 01 S	230	1.50 mm	0,161	2001603
60 AGH 01 S	230	1.50 mm	0,232	2001605
100 AGH 01 S	230	1.50 mm	0,267	2001607

L = BOY = LENGTH / T = KALINLIK = THICKNESS



H AGH 01 S			
Yükseklik Height	Kanal Tipi Type	Genişlik Width	Modül Module

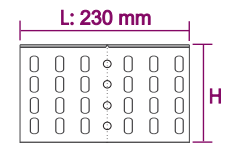
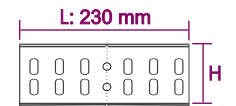
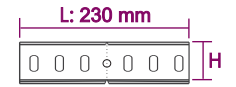

ARTIM METAL ELEKTRİK A.Ş.

* Farklı kalınlık ve ölçülerde üretim yapılabılır.
* Malzeme ağırlıkları yaklaşık değerlerdir, ± %10 değişiklik gösterebilir.
* Malzeme kalınlık toleransı ± %10 dur.
* Lütfen siparişlerinizde sipariş kodu veya ürün kodu ve Kaplama şeklini belirtiniz.

* We can produce cable trays different thickness and dimensions
* Cable trays are shown approximately weight, they could change ± %10 difference.
* Cable trays thickness tolerances are shown ± %10 .
* Please indicate order code and coating type in your orders.

AGH SERIES

DIKEY & YATAY SEVIYE DEGİSTİRME

VERTICAL & HORIZONTAL ANGLE CONNECTOR

SICAK DALDIRMA (SD)

HOT DIP GALVANIZED (HDG)

TS EN ISO 1461



H40 = H50 Tek delikli
H40 = H50 One hole

H60 = Çift delikli
H60 = Double hole

H100 = Dört delikli
H100 = Four holes

Ürün tek parça satılmaktadır. 1 Takım için;
4 adet Seviye Degistirici, 6 adet M8x15 Cıvata,
6 adet Somun kullanılmaktadır.

The product is sold in one piece. For 1 Team;
4 Angle Connector, 6 M8x15 Bolts,
6 Nuts are used.

DİKEY & VERTICAL				
Sipariş Kodu Order Code	L (mm)	T (mm)	Ağırlık (kg/ad) Weight (kg/pcs)	Barkod Kodu Barcode Code
40 AGH 00 S	160	1.50 mm	0,105	2001600
50 AGH 00 S	160	1.50 mm	0,130	2001602
60 AGH 00 S	160	1.50 mm	0,150	2001604
100 AGH 00 S	160	1.50 mm	0,225	2001606



H AGH 00 S

Yükseklik Kanal Tipi Genişlik Modül
Height Type Width Module

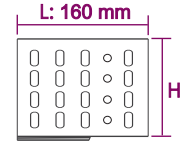
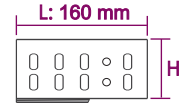
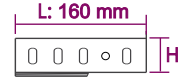

YATAY & HORIZONTAL

Sipariş Kodu Order Code	W (mm)	T (mm)	Ağırlık (kg/ad) Weight (kg/pcs)	Barkod Kodu Barcode Code
40 AGH 01 S	230	1.50 mm	0,096	2001601
50 AGH 01 S	230	1.50 mm	0,179	2001603
60 AGH 01 S	230	1.50 mm	0,256	2001605
100 AGH 01 S	230	1.50 mm	0,296	2001607

L = BOY = LENGTH / T = KALINLIK = THICKNESS



H40 = H50 Tek delikli
H40 = H50 One hole

H60 = Çift delikli
H60 = Double hole

H100 = Dört delikli
H100 = Four holes

Ürün tek parça satılmaktadır. 1 Takım için;
2 adet Seviye Degistirici, 4 adet M8x15 Cıvata,
4 adet Somun kullanılmaktadır.

The product is sold in one piece. For 1 Team;
4 Angle Connector, 4 M8x15 Bolts,
4 Nuts are used.



H AGH 01 S

Yükseklik Kanal Tipi Genişlik Modül
Height Type Width Module

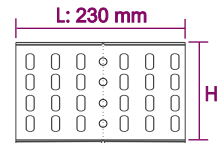
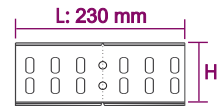

* Farklı kalınlık ve ölçülerde üretim yapılabılır.
* Malzeme ağırlıkları yaklaşık değerlerdir, ± %10 değişiklik gösterebilir.
* Malzeme kalınlık toleransı ± %10 dur.
* Lütfen siparişlerinizde sipariş kodu veya ürün kodu ve Kaplama şeklini belirtiniz.

* We can produce cable trays different thickness and dimensions
* Cable trays are shown approximately weight, they could change ± %10 difference.
* Cable trays thickness tolerances are shown ± %10 .
* Please indicate order code and coating type in your orders.

AGH SERIES

DIKEY T BAGLANTI

VERTICAL TEES

PREGALVANIZ (PG)
PREGALVANIZED (PG)
TS EN 10346



H40 = H50 Tek delikli
H40 = H50 One hole



H40

Sipariş Kodu Order Code	W (mm)	T (mm)	Ağırlık (kg/ad) Weight (kg/pcs)	Barkod Kodu Barcode Code
40 AGH 050 DD	50	1.50 mm	1,150	2001700
40 AGH 100 DD	100	1.50 mm	1,675	2001701
40 AGH 120 DD	120	1.50 mm	1,900	2001702
40 AGH 160 DD	160	1.50 mm	2,350	2001703
40 AGH 200 DD	200	1.50 mm	2,870	2001704
40 AGH 300 DD	300	1.50 mm	4,285	2001705
40 AGH 400 DD	400	2.00 mm	7,910	2001706
40 AGH 500 DD	500	2.00 mm	10,480	2001707
40 AGH 600 DD	600	2.00 mm	13,255	2001708

H50

Sipariş Kodu Order Code	W (mm)	T (mm)	Ağırlık (kg/ad) Weight (kg/pcs)	Barkod Kodu Barcode Code
50 AGH 050 DD	50	1.50 mm	1,290	2001718
50 AGH 100 DD	100	1.50 mm	1,825	2001719
50 AGH 120 DD	120	1.50 mm	2,342	2001762
50 AGH 160 DD	160	1.50 mm	2,860	2001720
50 AGH 200 DD	200	1.50 mm	3,045	2001721
50 AGH 300 DD	300	1.50 mm	4,485	2001722
50 AGH 400 DD	400	2.00 mm	8,210	2001723
50 AGH 500 DD	500	2.00 mm	10,810	2001724
50 AGH 600 DD	600	2.00 mm	13,620	2001725

H60

Sipariş Kodu Order Code	W (mm)	T (mm)	Ağırlık (kg/ad) Weight (kg/pcs)	Barkod Kodu Barcode Code
60 AGH 100 DD	100	1.50 mm	1,985	2001734
60 AGH 120 DD	120	1.50 mm	2,187	2001763
60 AGH 160 DD	160	1.50 mm	2,390	2001735
60 AGH 200 DD	200	1.50 mm	3,220	2001736
60 AGH 300 DD	300	2.00 mm	4,685	2001737
60 AGH 400 DD	400	2.00 mm	8,500	2001738
60 AGH 500 DD	500	2.00 mm	11,140	2001739
60 AGH 600 DD	600	2.00 mm	13,980	2001740

H100

Sipariş Kodu Order Code	W (mm)	T (mm)	Ağırlık (kg/ad) Weight (kg/pcs)	Barkod Kodu Barcode Code
100 AGH 100 DD	100	1.50 mm	2,570	2001748
100 AGH 120 DD	120	1.50 mm	2,922	2001764
100 AGH 160 DD	160	1.50 mm	3,275	2001749
100 AGH 200 DD	200	1.50 mm	3,910	2001750
100 AGH 300 DD	300	2.00 mm	5,455	2001751
100 AGH 400 DD	400	2.00 mm	9,670	2001752
100 AGH 500 DD	500	2.00 mm	12,430	2001753
100 AGH 600 DD	600	2.00 mm	14,670	2001754

H = YÜKSEKLİK = HEIGHT / W = GENİŞLİK = WIDTH / T = KALINLIK = THICKNESS

H AGH 100 DD

Yükseklik Kanal Tipi Genişlik Modül
Height Type Width Module

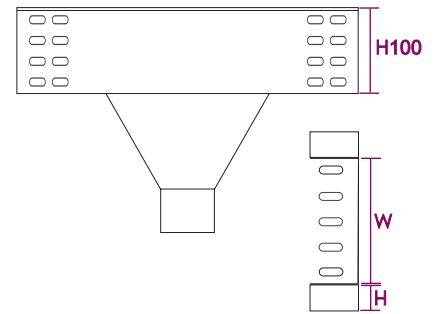
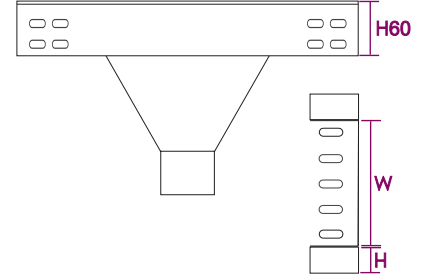
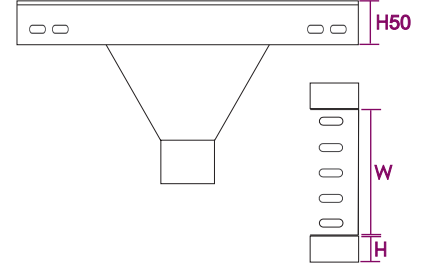
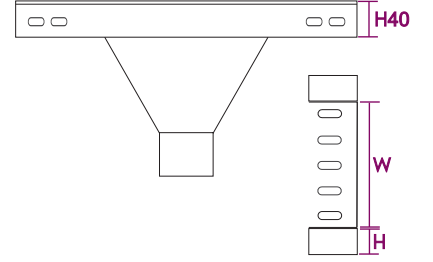

ARTIM METAL ELEKTRİK A.Ş.

* Farklı kalınlık ve ölçülerde üretim yapılabılır.
* Malzeme ağırlıkları yaklaşık değerlerdir, ± %10 değişiklik gösterebilir.
* Malzeme kalınlık toleransı ± %10 dur.
* Lütfen siparişlerinizde sipariş kodu veya ürün kodu ve Kaplama şeklini belirtiniz.

* We can produce cable trays different thickness and dimensions
* Cable trays are shown approximately weight, they could change ± %10 difference.
* Cable trays thickness tolerances are shown ± %10 .
* Please indicate order code and coating type in your orders.

AGH SERIES

DIKEY T BAGLANTI

VERTICAL TEES

SICAK DALDIRMA (SD)

HOT DIP GALVANIZED (SD)

TS EN ISO 1461



H40 = H50 Tek delikli
H40 = H50 One hole



H40

Sipariş Kodu Order Code	W (mm)	T (mm)	Ağırlık (kg/ad) Weight (kg/pcs)	Barkod Kodu Barcode Code
40 AGH 050 DD	50	1.50 mm	1,270	2001700
40 AGH 100 DD	100	1.50 mm	1,845	2001701
40 AGH 120 DD	120	1.50 mm	2,095	2001702
40 AGH 160 DD	160	1.50 mm	2,455	2001703
40 AGH 200 DD	200	1.50 mm	3,240	2001704
40 AGH 300 DD	300	1.50 mm	4,715	2001705
40 AGH 400 DD	400	2.00 mm	8,700	2001706
40 AGH 500 DD	500	2.00 mm	11,535	2001707
40 AGH 600 DD	600	2.00 mm	14,510	2001708

H50

Sipariş Kodu Order Code	W (mm)	T (mm)	Ağırlık (kg/ad) Weight (kg/pcs)	Barkod Kodu Barcode Code
50 AGH 050 DD	50	1.50 mm	1,420	2001718
50 AGH 100 DD	100	1.50 mm	2,010	2001719
50 AGH 120 DD	120	1.50 mm	2,580	2001762
50 AGH 160 DD	160	1.50 mm	3,150	2001720
50 AGH 200 DD	200	1.50 mm	3,350	2001721
50 AGH 300 DD	300	1.50 mm	4,930	2001722
50 AGH 400 DD	400	2.00 mm	9,030	2001723
50 AGH 500 DD	500	2.00 mm	11,890	2001724
50 AGH 600 DD	600	2.00 mm	14,985	2001725

H60

Sipariş Kodu Order Code	W (mm)	T (mm)	Ağırlık (kg/ad) Weight (kg/pcs)	Barkod Kodu Barcode Code
60 AGH 100 DD	100	1.50 mm	2,180	2001734
60 AGH 120 DD	120	1.50 mm	2,405	2001763
60 AGH 160 DD	160	1.50 mm	2,630	2001735
60 AGH 200 DD	200	1.50 mm	3,545	2001736
60 AGH 300 DD	300	1.50 mm	5,150	2001737
60 AGH 400 DD	400	2.00 mm	9,350	2001738
60 AGH 500 DD	500	2.00 mm	12,255	2001739
60 AGH 600 DD	600	2.00 mm	15,380	2001740

H100

Sipariş Kodu Order Code	W (mm)	T (mm)	Ağırlık (kg/ad) Weight (kg/pcs)	Barkod Kodu Barcode Code
100 AGH 100 DD	100	1.50 mm	2,830	2001748
100 AGH 120 DD	120	1.50 mm	3,215	2001764
100 AGH 160 DD	160	1.50 mm	3,600	2001749
100 AGH 200 DD	200	1.50 mm	4,295	2001750
100 AGH 300 DD	300	1.50 mm	6,000	2001751
100 AGH 400 DD	400	2.00 mm	10,635	2001752
100 AGH 500 DD	500	2.00 mm	13,670	2001753
100 AGH 600 DD	600	2.00 mm	16,135	2001754

H = YÜKSEKLİK = HEIGHT / W = GENİŞLİK = WIDTH / T = KALINLIK = THICKNESS

H AGH 100 DD

Yükseklik Kanal Tipi Genişlik Modül
Height Type Width Module

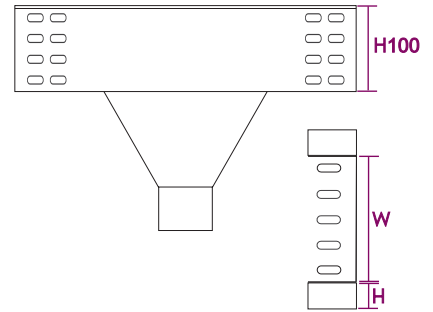
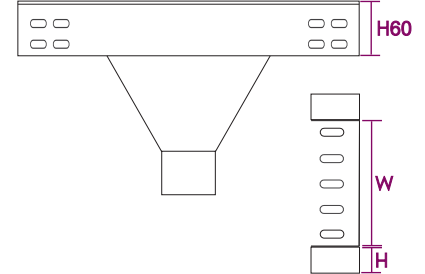
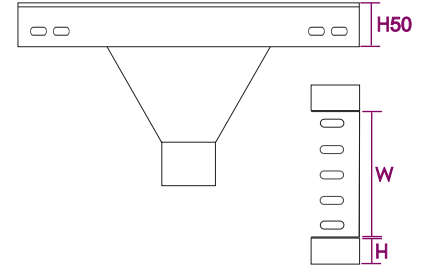
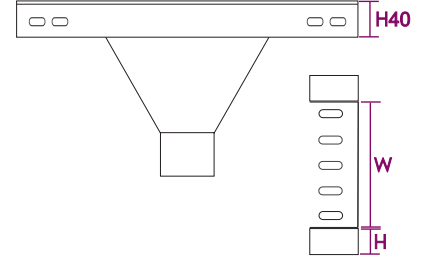

* Farklı kalınlık ve ölçülerde üretim yapılabılır.
* Malzeme ağırlıkları yaklaşık değerlerdir, ± %10 değişiklik gösterebilir.
* Malzeme kalınlık toleransı ± %10 dur.
* Lütfen siparişlerinizde sipariş kodu veya ürün kodu ve Kaplama şeklini belirtiniz.

* We can produce cable trays different thickness and dimensions
* Cable trays are shown approximately weight, they could change ± %10 difference.
* Cable trays thickness tolerances are shown ± %10 .
* Please indicate order code and coating type in your orders.

AGH SERIES

ORTADAN T BAĞLANTI

FRO MIDDLE VERTICAL TEES

PREGALVANİZ (PG)
PREGALVANİZED (PG)
TS EN 10346



H40 = H50 Tek delikli
H40 = H50 One hole

H40

Sipariş Kodu Order Code	W (mm)	T (mm)	Ağırlık (kg/ad) Weight (kg/pcs)	Barkod Kodu Barcode Code
40 AGH 050 DO	50	1.50 mm	1,615	2001709
40 AGH 100 DO	100	1.50 mm	2,040	2001710
40 AGH 120 DO	120	1.50 mm	2,210	2001711
40 AGH 160 DO	160	1.50 mm	2,545	2001712
40 AGH 200 DO	200	1.50 mm	2,885	2001713
40 AGH 300 DO	300	1.50 mm	3,735	2001714
40 AGH 400 DO	400	2.00 mm	6,100	2001715
40 AGH 500 DO	500	2.00 mm	7,230	2001716
40 AGH 600 DO	600	2.00 mm	8,355	2001717

H50

Sipariş Kodu Order Code	W (mm)	T (mm)	Ağırlık (kg/ad) Weight (kg/pcs)	Barkod Kodu Barcode Code
50 AGH 050 DO	50	1.50 mm	1,795	2001726
50 AGH 100 DO	100	1.50 mm	2,220	2001727
50 AGH 120 DO	120	1.50 mm	2,342	2001765
50 AGH 160 DO	160	1.50 mm	2,465	2001728
50 AGH 200 DO	200	1.50 mm	3,065	2001729
50 AGH 300 DO	300	1.50 mm	3,910	2001730
50 AGH 400 DO	400	2.00 mm	6,340	2001731
50 AGH 500 DO	500	2.00 mm	7,470	2001732
50 AGH 600 DO	600	2.00 mm	8,595	2001733

H60

Sipariş Kodu Order Code	W (mm)	T (mm)	Ağırlık (kg/ad) Weight (kg/pcs)	Barkod Kodu Barcode Code
60 AGH 100 DO	100	1.50 mm	2,140	2001741
60 AGH 120 DO	120	1.50 mm	2,525	2001766
60 AGH 160 DO	160	1.50 mm	2,910	2001742
60 AGH 200 DO	200	1.50 mm	3,250	2001743
60 AGH 300 DO	300	2.00 mm	4,095	2001744
60 AGH 400 DO	400	2.00 mm	6,590	2001745
60 AGH 500 DO	500	2.00 mm	7,715	2001746
60 AGH 600 DO	600	2.00 mm	8,840	2001747

H100

Sipariş Kodu Order Code	W (mm)	T (mm)	Ağırlık (kg/ad) Weight (kg/pcs)	Barkod Kodu Barcode Code
100 AGH 100 DO	100	1.50 mm	3,150	2001755
100 AGH 120 DO	120	1.50 mm	3,405	2001767
100 AGH 160 DO	160	1.50 mm	3,660	2001756
100 AGH 200 DO	200	1.50 mm	4,000	2001757
100 AGH 300 DO	300	2.00 mm	4,485	2001758
100 AGH 400 DO	400	2.00 mm	7,590	2001759
100 AGH 500 DO	500	2.00 mm	8,715	2001760
100 AGH 600 DO	600	2.00 mm	9,840	2001761

H = YÜKSEKLİK = HEIGHT / W = GENİŞLİK = WIDTH / T = KALINLIK = THICKNESS

H AGH 100 DO

Yükseklik Kanal Tipi Genişlik Modül
Height Type Width Module

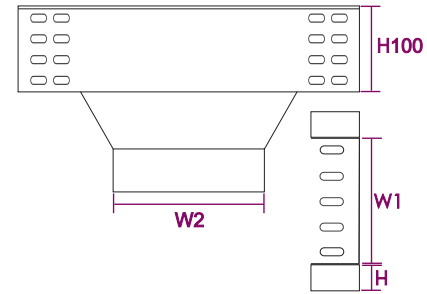
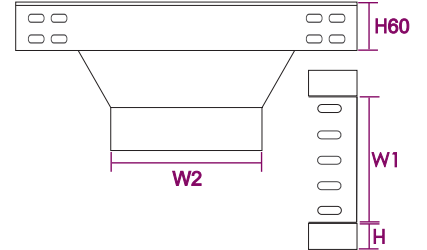
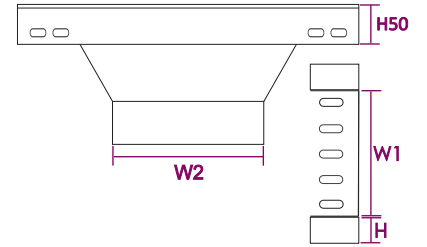
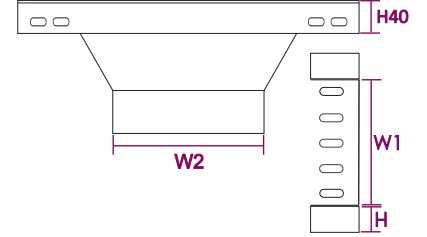

ARTIM METAL ELEKTRİK A.Ş.

* Farklı kalınlık ve ölçülerde üretim yapılabılır.
* Malzeme ağırlıkları yaklaşık değerlerdir, ± %10 değişiklik gösterebilir.
* Malzeme kalınlık toleransı ± %10 dur.
* Lütfen siparişlerinizde sipariş kodu veya ürün kodu ve Kaplama şeklini belirtiniz.

* We can produce cable trays different thickness and dimensions
* Cable trays are shown approximately weight, they could change ± %10 difference.
* Cable trays thickness tolerances are shown ± %10 .
* Please indicate order code and coating type in your orders.

AGH SERIES

ORTADAN T BAĞLANTI

FRO MIDDLE VERTICAL TEES

SICAK DALDIRMA (SD)

HOT DIP GALVANIZED (SD)

TS EN ISO 1461



H40 = H50 Tek delikli
H40 = H50 One hole

H40

Sipariş Kodu Order Code	W (mm)	T (mm)	Ağırlık (kg/ad) Weight (kg/pcs)	Barkod Kodu Barcode Code
40 AGH 050 DO	50	1.50 mm	1,775	2001709
40 AGH 100 DO	100	1.50 mm	2,455	2001710
40 AGH 120 DO	120	1.50 mm	2,430	2001711
40 AGH 160 DO	160	1.50 mm	2,800	2001712
40 AGH 200 DO	200	1.50 mm	3,170	2001713
40 AGH 300 DO	300	1.50 mm	4,105	2001714
40 AGH 400 DO	400	2.00 mm	6,710	2001715
40 AGH 500 DO	500	2.00 mm	7,950	2001716
40 AGH 600 DO	600	2.00 mm	9,190	2001717

H50

Sipariş Kodu Order Code	W (mm)	T (mm)	Ağırlık (kg/ad) Weight (kg/pcs)	Barkod Kodu Barcode Code
50 AGH 050 DO	50	1.50 mm	1,975	2001726
50 AGH 100 DO	100	1.50 mm	2,445	2001727
50 AGH 120 DO	120	1.50 mm	2,580	2001765
50 AGH 160 DO	160	1.50 mm	2,715	2001728
50 AGH 200 DO	200	1.50 mm	3,370	2001729
50 AGH 300 DO	300	1.50 mm	4,295	2001730
50 AGH 400 DO	400	2.00 mm	6,975	2001731
50 AGH 500 DO	500	2.00 mm	8,215	2001732
50 AGH 600 DO	600	2.00 mm	9,455	2001733

H60

Sipariş Kodu Order Code	W (mm)	T (mm)	Ağırlık (kg/ad) Weight (kg/pcs)	Barkod Kodu Barcode Code
60 AGH 100 DO	100	1.50 mm	2,650	2001741
60 AGH 120 DO	120	1.50 mm	2,927	2001766
60 AGH 160 DO	160	1.50 mm	3,205	2001742
60 AGH 200 DO	200	1.50 mm	3,575	2001743
60 AGH 300 DO	300	1.50 mm	4,505	2001744
60 AGH 400 DO	400	2.00 mm	7,245	2001745
60 AGH 500 DO	500	2.00 mm	8,485	2001746
60 AGH 600 DO	600	2.00 mm	9,725	2001747

H100

Sipariş Kodu Order Code	W (mm)	T (mm)	Ağırlık (kg/ad) Weight (kg/pcs)	Barkod Kodu Barcode Code
100 AGH 100 DO	100	1.50 mm	3,465	2001755
100 AGH 120 DO	120	1.50 mm	3,747	2001767
100 AGH 160 DO	160	1.50 mm	4,030	2001756
100 AGH 200 DO	200	1.50 mm	4,400	2001757
100 AGH 300 DO	300	1.50 mm	5,330	2001758
100 AGH 400 DO	400	2.00 mm	8,345	2001759
100 AGH 500 DO	500	2.00 mm	9,585	2001760
100 AGH 600 DO	600	2.00 mm	10,825	2001761

H = YÜKSEKLİK = HEIGHT / W = GENİŞLİK = WIDTH / T = KALINLIK = THICKNESS

H AGH 100 DO

Yükseklik Kanal Tipi Genişlik Modül
Height Type Width Module

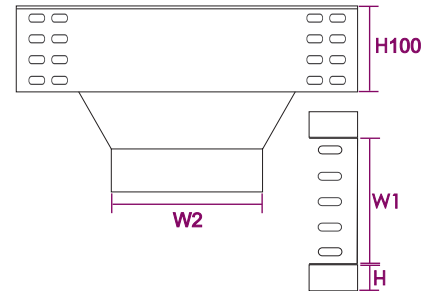
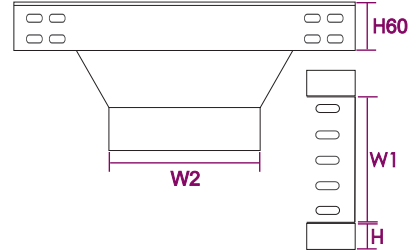
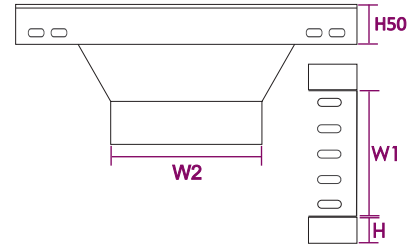
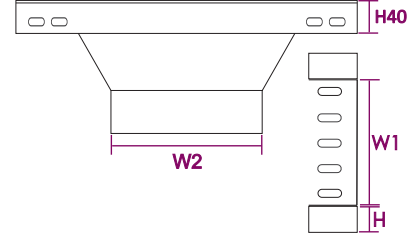

* Farklı kalınlık ve ölçülerde üretim yapılabılır.
* Malzeme ağırlıkları yaklaşık değerlerdir, ± %10 değişiklik gösterebilir.
* Malzeme kalınlık toleransı ± %10 dur.
* Lütfen siparişlerinizde sipariş kodu veya ürün kodu ve kaplama şeklini belirtiniz.

* We can produce cable trays different thickness and dimensions
* Cable trays are shown approximately weight, they could change ± %10 difference.
* Cable trays thickness tolerances are shown ± %10 .
* Please indicate order code and coating type in your orders.

AST & AGH SERIES

KANAL SEPERATÖRLERİ

CABLE SEPARATORS

PREGALVANIZ (PG)
PREGALVANIZED (PG)
TS EN 10346



H40 = H50 = H60 = H100 Tek delikli
H40 = H50 = H60 = H100 One hole



H40

Sipariş Kodu Order Code	L (mm)	T (mm)	Ağırlık (kg/m) Weight (kg/m)	Barkod Kodu Barcode Code
40 AST SP-12	3.000	1.20 mm	0,620	2001800
40 AST SP-15	3.000	1.50 mm	0,714	2001801

H50

Sipariş Kodu Order Code	L (mm)	T (mm)	Ağırlık (kg/m) Weight (kg/m)	Barkod Kodu Barcode Code
50 AST SP-12	3.000	1.20 mm	0,707	2001803
50 AST SP-15	3.000	1.50 mm	0,824	2001804

H60

Sipariş Kodu Order Code	L (mm)	T (mm)	Ağırlık (kg/m) Weight (kg/m)	Barkod Kodu Barcode Code
60 AST SP-15	3.000	1.50 mm	0,935	2001806

H75

Sipariş Kodu Order Code	L (mm)	T (mm)	Ağırlık (kg/m) Weight (kg/m)	Barkod Kodu Barcode Code
75 AST SP-15	3.000	1.50 mm	1,099	2001811

H100

Sipariş Kodu Order Code	L (mm)	T (mm)	Ağırlık (kg/m) Weight (kg/m)	Barkod Kodu Barcode Code
100 AST SP-15	3.000	1.50 mm	1,373	2001808

H = YÜKSEKLİK = HEIGHT / L = BOY = LENGTH / T = KALINLIK = THICKNESS

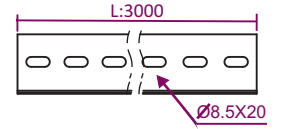
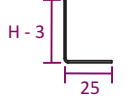

H40

Sipariş Kodu Order Code	L (mm)	T (mm)	Ağırlık (kg/m) Weight (kg/m)	Barkod Kodu Barcode Code
40 AGH SP-15	3.000	1.50 mm	0,824	2001802

H50

Sipariş Kodu Order Code	L (mm)	T (mm)	Ağırlık (kg/m) Weight (kg/m)	Barkod Kodu Barcode Code
50 AGH SP-15	3.000	1.50 mm	0,934	2001805

H60

Sipariş Kodu Order Code	L (mm)	T (mm)	Ağırlık (kg/m) Weight (kg/m)	Barkod Kodu Barcode Code
60 AGH SP-15	3.000	1.50 mm	1,045	2001807

H75

Sipariş Kodu Order Code	L (mm)	T (mm)	Ağırlık (kg/m) Weight (kg/m)	Barkod Kodu Barcode Code
75 AGH SP-15	3.000	1.50 mm	1,209	2001810

H100

Sipariş Kodu Order Code	L (mm)	T (mm)	Ağırlık (kg/m) Weight (kg/m)	Barkod Kodu Barcode Code
100 AGH SP-15	3.000	1.50 mm	1,483	2001809

H = YÜKSEKLİK = HEIGHT / L = BOY = LENGTH / T = KALINLIK = THICKNESS

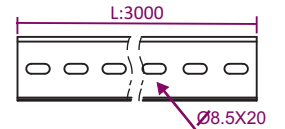
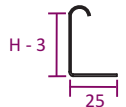

H40 = H50 = H60 = H100 Tek delikli
H40 = H50 = H60 = H100 One hole

ARTIM METAL ELEKTRİK A.Ş.

* Farklı kalınlık ve ölçülerde üretim yapılabılır.
* Malzeme ağırlıkları yaklaşık değerlerdir, ± %10 değişiklik gösterebilir.
* Malzeme kalınlık toleransı ± %10 dur.
* Lütfen siparişlerinizde sipariş kodu veya ürün kodu ve Kaplama şeklini belirtiniz.

* We can produce cable trays different thickness and dimensions
* Cable trays are shown approximately weight, they could change ± %10 difference.
* Cable trays thickness tolerances are shown ± %10 .
* Please indicate order code and coating type in your orders.

AST & AGH SERIES

KANAL SEPERATÖRLERİ

CABLE SEPARATORS

SICAK DALDIRMA (SD)

HOT DIP GALVANIZED (SD)

TS EN ISO 1461



H40				
Sipariş Kodu Order Code	L (mm)	T (mm)	Ağırlık (kg/m) Weight (kg/m)	Barkod Kodu Barcode Code
40 AST SP-12	3.000	1.20 mm	0,682	2001800
40 AST SP-15	3.000	1.50 mm	0,785	2001801

H50				
Sipariş Kodu Order Code	L (mm)	T (mm)	Ağırlık (kg/m) Weight (kg/m)	Barkod Kodu Barcode Code
50 AST SP-12	3.000	1.20 mm	0,778	2001803
50 AST SP-15	3.000	1.50 mm	0,906	2001804

H60				
Sipariş Kodu Order Code	L (mm)	T (mm)	Ağırlık (kg/m) Weight (kg/m)	Barkod Kodu Barcode Code
60 AST SP-15	3.000	1.50 mm	1,028	2001806

H75				
Sipariş Kodu Order Code	L (mm)	T (mm)	Ağırlık (kg/m) Weight (kg/m)	Barkod Kodu Barcode Code
75 AST SP-15	3.000	1.50 mm	1,209	2001811

H100				
Sipariş Kodu Order Code	L (mm)	T (mm)	Ağırlık (kg/m) Weight (kg/m)	Barkod Kodu Barcode Code
100 AST SP-15	3.000	1.50 mm	1,510	2001808

H = YÜKSEKLİK = HEIGHT / L = BOY = LENGTH / T = KALINLIK = THICKNESS

H40 = H50 = H60 = H100 Tek delikli
H40 = H50 =H60 =H100 One hole

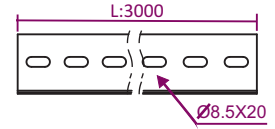
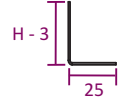
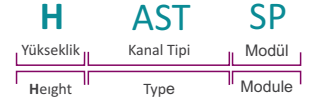

H40				
Sipariş Kodu Order Code	L (mm)	T (mm)	Ağırlık (kg/m) Weight (kg/m)	Barkod Kodu Barcode Code
40 AGH 03S	3.000	1.50 mm	0,906	2001802

H50				
Sipariş Kodu Order Code	L (mm)	T (mm)	Ağırlık (kg/m) Weight (kg/m)	Barkod Kodu Barcode Code
50 AGH 06S	3.000	1.50 mm	1,027	2001805

H60				
Sipariş Kodu Order Code	L (mm)	T (mm)	Ağırlık (kg/m) Weight (kg/m)	Barkod Kodu Barcode Code
60 AGH 08S	3.000	1.50 mm	1,149	2001807

H100				
Sipariş Kodu Order Code	L (mm)	T (mm)	Ağırlık (kg/m) Weight (kg/m)	Barkod Kodu Barcode Code
100 AGH 10S	3.000	1.50 mm	1,631	2001809

H = YÜKSEKLİK = HEIGHT / L = BOY = LENGTH / T = KALINLIK = THICKNESS

H40 = H50 = H60 = H100 Tek delikli
H40 = H50 =H60 =H100 One hole

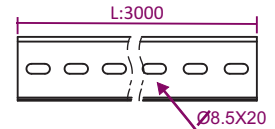
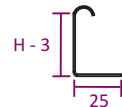

* Farklı kalınlık ve ölçülerde üretim yapılabılır.
* Malzeme ağırlıkları yaklaşık değerlerdir, ± %10 değişiklik gösterebilir.
* Malzeme kalınlık toleransı ± %10 dur.
* Lütfen siparişlerinizde sipariş kodu veya ürün kodu ve Kaplama şeklini belirtiniz.

* We can produce cable trays different thickness and dimensions
* Cable trays are shown approximately weight, they could change ± %10 difference.
* Cable trays thickness tolerances are shown ± %10 .
* Please indicate order code and coating type in your orders.

AGH SERIES

EK ELEMANI

STRAIGHT CONNECTION COUPLER

PREGALVANIZ (PG)
PREGALVANIZ (PG)
TS EN 10346



H40 = H50 = Tek delikli
H40 = H50 = One hole

H60 = İki delikli
H60 = Two holes

H100 = Dört delikli
H100 = Four holes

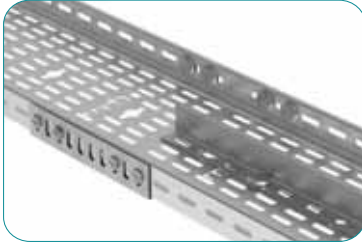

H40

Sipariş Kodu Order Code	T (mm)	Ağırlık (kg/ad) Weight (kg/pcs)	Paket İçi(ad) In Package(Pcs)	Barkod Kodu Barcode Code
40 AST 1	1.20 mm	0,088	300	2001001
40 AST 2	1.50 mm	0,108	250	2001002
40 AST 3	2.00 mm	0,142	200	2001003

H50

Sipariş Kodu Order Code	T (mm)	Ağırlık (kg/ad) Weight (kg/pcs)	Paket İçi(ad) In Package(Pcs)	Barkod Kodu Barcode Code
50 AST 1	1.20 mm	0,110	250	2001008
50 AST 2	1.50 mm	0,135	200	2001009
50 AST 3	2.00 mm	0,180	150	2001010

H60

Sipariş Kodu Order Code	T (mm)	Ağırlık (kg/ad) Weight (kg/pcs)	Paket İçi(ad) In Package(Pcs)	Barkod Kodu Barcode Code
60 AST 1	1.20 mm	0,125	200	2001015
60 AST 2	1.50 mm	0,157	-	2001016
60 AST 3	2.00 mm	0,205	-	2001017

H100

Sipariş Kodu Order Code	T (mm)	Ağırlık (kg/ad) Weight (kg/pcs)	Paket İçi(ad) In Package(Pcs)	Barkod Kodu Barcode Code
100 AST 1	1.20 mm	0,192	-	2001019
100 AST 2	1.50 mm	0,240	-	2001020
100 AST 3	2.00 mm	0,320	-	2001021

H = YÜKSEKLİK = HEIGHT / T = KALINLIK = THICKNESS / L = BOY = LENGTH = 175 mm

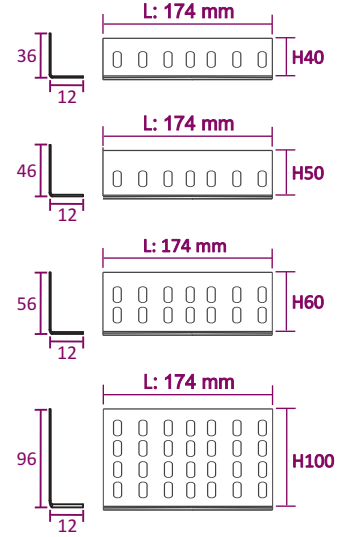

1 Adet H40 - H50 Ek montajı için;
M8x15 Civata 4 Adet M8 Somun 4 Adet kullanılmalıdır.
1 Adet H60 - H75 - H100 Ek montajı için;
M8x15 Civata 8 Adet M8 Somun 8 Adet kullanılmalıdır.

For the installation of 1 H40 - H50 Splice;
M8x15 Bolts 4 Pieces M8 Nuts 4 Pieces must be used.
1 piece H60 - H75 - H100 for additional assembly;
M8x15 Bolts 8 Pieces M8 Nuts 8 Pieces should be used.

H40

Sipariş Kodu Order Code	T (mm)	Ağırlık (kg/ad) Weight (kg/pcs)	Paket İçi(ad) In Package(Pcs)	Barkod Kodu Barcode Code
40 AST 2A	1.50 mm	0,135	-	2001007

H50

Sipariş Kodu Order Code	T (mm)	Ağırlık (kg/ad) Weight (kg/pcs)	Paket İçi(ad) In Package(Pcs)	Barkod Kodu Barcode Code
50 AST 2A	1.50 mm	0,160	-	2001014

H60

Sipariş Kodu Order Code	T (mm)	Ağırlık (kg/ad) Weight (kg/pcs)	Paket İçi(ad) In Package(Pcs)	Barkod Kodu Barcode Code
60 AST 2A	1.50 mm	0,180	-	2001018

H100

Sipariş Kodu Order Code	T (mm)	Ağırlık (kg/ad) Weight (kg/pcs)	Paket İçi(ad) In Package(Pcs)	Barkod Kodu Barcode Code
100 AST 2A	1.50 mm	0,350	-	2001022

H = YÜKSEKLİK = HEIGHT / T = KALINLIK = THICKNESS / L = BOY = LENGTH = 175 mm

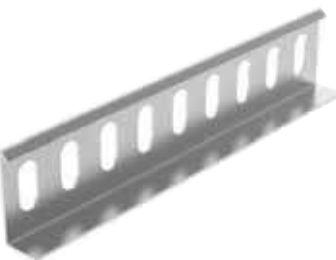
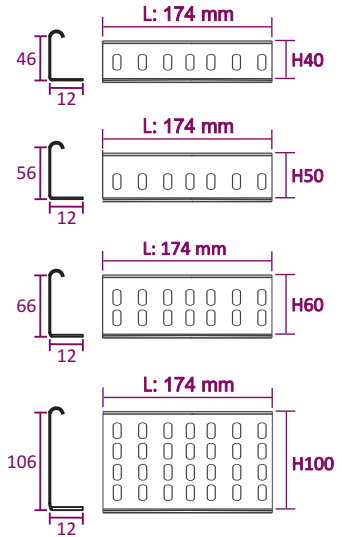

H40 = H50 = Tek delikli
H40 = H50 = One hole

H60 = İki delikli
H60 = Two holes

H100 = Dört delikli
H100 = Four holes

ARTIM METAL ELEKTRİK A.Ş.

* Farklı kalınlık ve ölçülerde üretim yapılabılır.
* Malzeme ağırlıkları yaklaşık değerlerdir, \pm %10 değişiklik gösterebilir.
* Malzeme kalınlık toleransı \pm %10 dur.
* Lütfen siparişlerinizde sipariş kodu veya ürün kodu ve Kaplama şeklini belirtiniz.

* We can produce cable trays different thickness and dimensions
* Cable trays are shown approximately weight, they could change \pm %10 difference.
* Cable trays thickness tolerances are shown \pm %10 .
* Please indicate order code and coating type in your orders.

AGH SERIES

EK ELEMANI

STRAIGHT CONNECTION COUPLER

SICAK DALDIRMA (SD)

HOT DIP GALVANIZED (SD)

TS EN ISO 1461



H40 = H50 = Tek delikli
H40 = H50 = One hole

H60 = İki delikli
H60 = Two holes

H100 = Dört delikli
H100 = Four holes

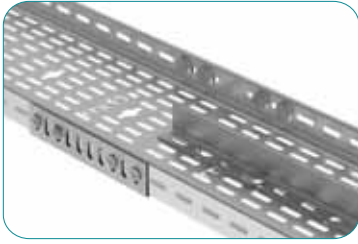

H40

Sipariş Kodu Order Code	T (mm)	Ağırlık (kg/ad) Weight (kg/pcs)	Paket İçi(ad) in Package(Pcs)	Barkod Kodu Barcode Code
40 AST 1	1.20 mm	0,096	300	2001001
40 AST 2	1.50 mm	0,120	250	2001002
40 AST 3	2.00 mm	0,160	200	2001003

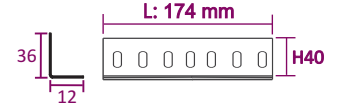

H50

Sipariş Kodu Order Code	T (mm)	Ağırlık (kg/ad) Weight (kg/pcs)	Paket İçi(ad) in Package(Pcs)	Barkod Kodu Barcode Code
50 AST 1	1.20 mm	0,120	250	2001008
50 AST 2	1.50 mm	0,150	200	2001009
50 AST 3	2.00 mm	0,200	150	2001010

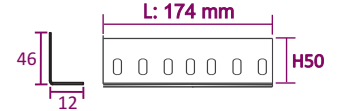

H60

Sipariş Kodu Order Code	T (mm)	Ağırlık (kg/ad) Weight (kg/pcs)	Paket İçi(ad) in Package(Pcs)	Barkod Kodu Barcode Code
60 AST 1	1.20 mm	0,135	200	2001015
60 AST 2	1.50 mm	0,169	-	2001016
60 AST 3	2.00 mm	0,225	-	2001017

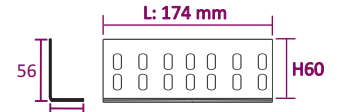

H100

Sipariş Kodu Order Code	T (mm)	Ağırlık (kg/ad) Weight (kg/pcs)	Paket İçi(ad) in Package(Pcs)	Barkod Kodu Barcode Code
100 AST 1	1.20 mm	0,212	-	2001019
100 AST 2	1.50 mm	0,265	-	2001020
100 AST 3	2.00 mm	0,350	-	2001021

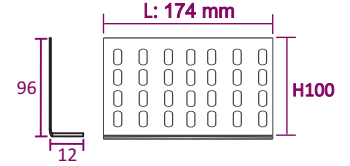

H = YÜKSEKLİK = HEIGHT / T = KALINLIK = THICKNESS / L = BOY = LENGTH = 175 mm

1 Adet H40 - H50 Ek montajı için;
M8x15 Civata 4 Adet M8 Somun 4 Adet kullanılmalıdır.
1 Adet H60 - H75 - H100 Ek montajı için;
M8x15 Civata 8 Adet M8 Somun 8 Adet kullanılmalıdır.

For the installation of 1 H40 - H50 Splice;
M8x15 Bolts 4 Pieces M8 Nuts 4 Pieces must be used.
1 piece H60 - H75 - H100 for additional assembly;
M8x15 Bolts 8 Pieces M8 Nuts 8 Pieces should be used.

H40

Sipariş Kodu Order Code	T (mm)	Ağırlık (kg/ad) Weight (kg/pcs)	Paket İçi(ad) in Package(Pcs)	Barkod Kodu Barcode Code
40 AST 2A	1.50 mm	0,150	-	2001007

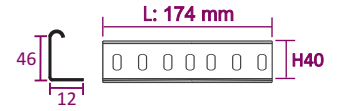

H50

Sipariş Kodu Order Code	T (mm)	Ağırlık (kg/ad) Weight (kg/pcs)	Paket İçi(ad) in Package(Pcs)	Barkod Kodu Barcode Code
50 AST 2A	1.50 mm	0,175	-	2001014

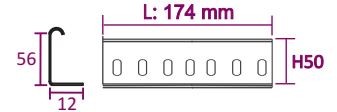

H60

Sipariş Kodu Order Code	T (mm)	Ağırlık (kg/ad) Weight (kg/pcs)	Paket İçi(ad) in Package(Pcs)	Barkod Kodu Barcode Code
60 AST 2A	1.50 mm	0,195	-	2001018

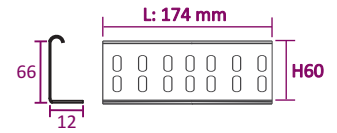

H100

Sipariş Kodu Order Code	T (mm)	Ağırlık (kg/ad) Weight (kg/pcs)	Paket İçi(ad) in Package(Pcs)	Barkod Kodu Barcode Code
100 AST 2A	1.50 mm	0,390	-	2001022

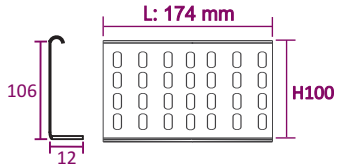

H = YÜKSEKLİK = HEIGHT / T = KALINLIK = THICKNESS / L = BOY = LENGTH = 175 mm



H40 = H50 = Tek delikli
H40 = H50 = One hole

H60 = İki delikli
H60 = Two holes

H100 = Dört delikli
H100 = Four holes

* Farklı kalınlık ve ölçülerde üretim yapılabılır.
* Malzeme ağırlıkları yaklaşık değerlerdir, ± %10 değişiklik gösterebilir.
* Malzeme kalınlık toleransı ± %10 dur.
* Lütfen siparişlerinizde sipariş kodu veya ürün kodu ve Kaplama şeklini belirtiniz.

* We can produce cable trays different thickness and dimensions
* Cable trays are shown approximately weight, they could change ± %10 difference.
* Cable trays thickness tolerances are shown ± %10 .
* Please indicate order code and coating type in your orders.