

art

POWER CARRYING SOLUTIONS



KABLO KANAL VE MERDİVEN KAPAKLARI

CABLE TRAY AND LADDER COVERS

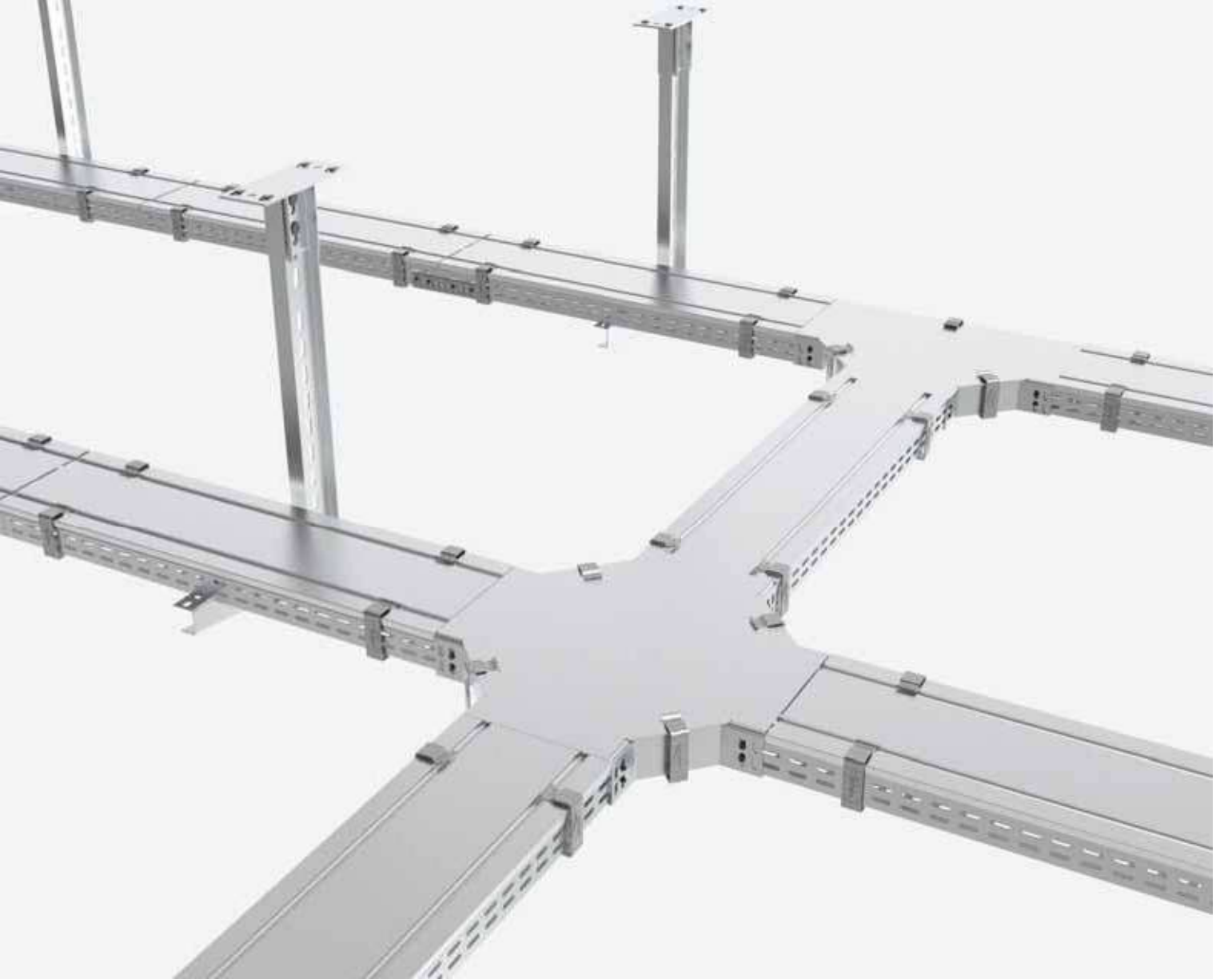

AKK SERIES

KABLO KANALI VE KABLO MERDIVENİ KAPAKLARI

CABLE TRAY AND CABLE LADDER COVERS

PREGALVANİZ (PG)

PREGALVANIZED (PG)

TS EN 10346



0.80 mm

Sipariş Kodu Order Code	W (mm)	T (mm)	Ağırlık (kg/m) Weight (kg/m)	Barkod Kodu Barcode Code
AKK 050-08	50	0.80 mm	0,440	2002000
AKK 100-08	100	0.80 mm	0,756	2002001
AKK 120-08	120	0.80 mm	0,880	2002002
AKK 160-08	160	0.80 mm	1,132	2002003
AKK 200-09	200	0.90 mm	1,557	2002004

AKK 100 - 10



1.00 mm

Sipariş Kodu Order Code	W (mm)	T (mm)	Ağırlık (kg/m) Weight (kg/m)	Barkod Kodu Barcode Code
AKK 050-10	50	1.00 mm	0,550	2002005
AKK 100-10	100	1.00 mm	0,945	2002006
AKK 120-10	120	1.00 mm	1,100	2002007
AKK 160-10	160	1.00 mm	1,415	2002008
AKK 200-10	200	1.00 mm	1,730	2002009
AKK 300-10	300	1.00 mm	2,512	2002010

1.20 mm

Sipariş Kodu Order Code	W (mm)	T (mm)	Ağırlık (kg/m) Weight (kg/m)	Barkod Kodu Barcode Code
AKK 050-12	50	1.20 mm	0,660	2002011
AKK 100-12	100	1.20 mm	1,130	2002012
AKK 120-12	120	1.20 mm	1,320	2002013
AKK 160-12	160	1.20 mm	1,698	2002014
AKK 200-12	200	1.20 mm	2,075	2002015
AKK 300-12	300	1.20 mm	3,015	2002016
AKK 400-12	400	1.20 mm	3,960	2002017
AKK 500-12	500	1.20 mm	4,000	2002018

1.50 mm

Sipariş Kodu Order Code	W (mm)	T (mm)	Ağırlık (kg/m) Weight (kg/m)	Barkod Kodu Barcode Code
AKK 050-15	50	1.50 mm	0,825	2002019
AKK 100-15	100	1.50 mm	1,415	2002020
AKK 120-15	120	1.50 mm	1,650	2002021
AKK 160-15	160	1.50 mm	2,120	2002022
AKK 200-15	200	1.50 mm	2,595	2002023
AKK 300-15	300	1.50 mm	3,770	2002024
AKK 400-15	400	1.50 mm	4,950	2002025
AKK 500-15	500	1.50 mm	6,125	2002026
AKK 600-15	600	1.50 mm	7,305	2002027

2.00 mm

Sipariş Kodu Order Code	W (mm)	T (mm)	Ağırlık (kg/m) Weight (kg/m)	Barkod Kodu Barcode Code
AKK 050-20	50	2.00 mm	1,100	2002028
AKK 100-20	100	2.00 mm	1,886	2002029
AKK 160-20	160	2.00 mm	2,826	2002031
AKK 200-20	200	2.00 mm	3,460	2002032
AKK 300-20	300	2.00 mm	5,025	2002033
AKK 400-20	400	2.00 mm	6,595	2002034
AKK 500-20	500	2.00 mm	6,165	2002035
AKK 600-20	600	2.00 mm	9,735	2002036

L : 3000

Standart uzunluk L:3000 mm
Toplu miktarlarda Özel ölçüler yapılabilir.
Standard Length L:3000 mm
Custom sizes can be made in bulk quantities.

ARTIM METAL ELEKTRİK A.Ş.

W = GENİŞLİK = WIDTH / T = KALINLIK = THICKNESS

* Farklı kalınlık ve ölçülerde üretim yapılabılır.
* Malzeme ağırlıkları yaklaşık değerlerdir, \pm %10 değişiklik gösterebilir.
* Malzeme kalınlık toleransı \pm %10 dur.
* Lütfen siparişlerinizde sipariş kodu veya ürün kodu ve Kaplama şeklini belirtiniz.

* We can produce cable trays different thickness and dimensions
* Cable trays are shown approximately weight, they could change \pm %10 difference.
* Cable trays thickness tolerances are shown \pm %10 .
* Please indicate order code and coating type in your orders.

AKK SERIES

KABLO KANALI VE KABLO MERDİVENİ KAPAKLARI

CABLE TRAY AND CABLE LADDER COVERS

SICAK DALDIRMA (SD)

HOT DIP GALVANIZED (HDG)

TS EN ISO 1461

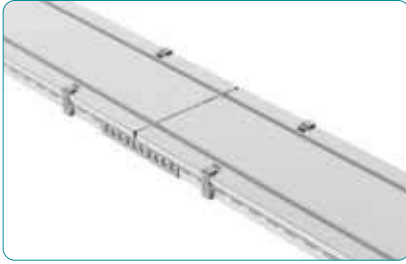

0.80 mm

Sipariş Kodu Order Code	W (mm)	T (mm)	Ağırlık (kg/m) Weight (kg/m)	Barkod Kodu Barcode Code
AKK 050-08	50	0.80 mm	0,485	2002000
AKK 100-08	100	0.80 mm	0,832	2002001
AKK 120-08	120	0.80 mm	0,968	2002002
AKK 160-08	160	0.80 mm	1,244	2002003
AKK 200-09	200	0.90 mm	1,710	2002004

1.00 mm

Sipariş Kodu Order Code	W (mm)	T (mm)	Ağırlık (kg/m) Weight (kg/m)	Barkod Kodu Barcode Code
AKK 050-10	50	1.00 mm	0,604	2002005
AKK 100-10	100	1.00 mm	1,040	2002006
AKK 120-10	120	1.00 mm	1,210	2002007
AKK 160-10	160	1.00 mm	1,555	2002008
AKK 200-10	200	1.00 mm	1,900	2002009
AKK 300-10	300	1.00 mm	2,766	2002010

1.20 mm

Sipariş Kodu Order Code	W (mm)	T (mm)	Ağırlık (kg/m) Weight (kg/m)	Barkod Kodu Barcode Code
AKK 050-12	50	1.20 mm	0,725	2002011
AKK 100-12	100	1.20 mm	1,245	2002012
AKK 120-12	120	1.20 mm	1,452	2002013
AKK 160-12	160	1.20 mm	1,866	2002014
AKK 200-12	200	1.20 mm	2,280	2002015
AKK 300-12	300	1.20 mm	3,320	2002016
AKK 400-12	400	1.20 mm	4,352	2002017
AKK 500-12	500	1.20 mm	5,388	2002018

1.50 mm

Sipariş Kodu Order Code	W (mm)	T (mm)	Ağırlık (kg/m) Weight (kg/m)	Barkod Kodu Barcode Code
AKK 050-15	50	1.50 mm	0,910	2002019
AKK 100-15	100	1.50 mm	1,555	2002020
AKK 120-15	120	1.50 mm	1,815	2002021
AKK 160-15	160	1.50 mm	2,335	2002022
AKK 200-15	200	1.50 mm	2,850	2002023
AKK 300-15	300	1.50 mm	4,145	2002024
AKK 400-15	400	1.50 mm	5,440	2002025
AKK 500-15	500	1.50 mm	6,735	2002026
AKK 600-15	600	1.50 mm	8,035	2002027

2.00 mm

Sipariş Kodu Order Code	W (mm)	T (mm)	Ağırlık (kg/m) Weight (kg/m)	Barkod Kodu Barcode Code
AKK 050-20	50	2.00 mm	1,213	2002028
AKK 100-20	100	2.00 mm	2,073	2002029
AKK 160-20	160	2.00 mm	3,113	2002031
AKK 200-20	200	2.00 mm	3,800	2002032
AKK 300-20	300	2.00 mm	5,530	2002033
AKK 400-20	400	2.00 mm	7,255	2002034
AKK 500-20	500	2.00 mm	8,980	2002035
AKK 600-20	600	2.00 mm	10,710	2002036

W = GENİŞLİK = WIDTH / T = KALINLIK = THICKNESS

AKK 100 - 10



Standart uzunluk L:3000 mm
Toplu miktarlarda Özel ölçüler yapılabilir.
Standard Length L:3000 mm
Custom sizes can be made in bulk quantities.

* Farklı kalınlık ve ölçülerde üretim yapılabılır.
* Malzeme ağırlıkları yaklaşık değerlerdir, \pm %10 değişiklik gösterebilir.
* Malzeme kalınlık toleransı \pm %10 dur.
* Lütfen siparişlerinizde sipariş kodu veya ürün kodu ve Kaplama şeklini belirtiniz.

* We can produce cable trays different thickness and dimensions
* Cable trays are shown approximately weight, they could change \pm %10 difference.
* Cable trays thickness tolerances are shown \pm %10 .
* Please indicate order code and coating type in your orders.

AKK SERIES

KABLO KANALI 90° YATAY DÖNÜS KAPAGI

CABLE TRAY 90° BEND COVERS

PREGALVANİZ (PG)
PREGALVANIZED (PG)
TS EN 10346



90°

Sipariş Kodu Order Code	W (mm)	T (mm)	Ağırlık (kg/ad) Weight (kg/pcs)	Barkod Kodu Barcode Code
AKK 050Y	50	1.20 mm	0,120	2001601
AKK 100Y	100	1.20 mm	0,245	2001602
AKK 120Y	120	1.20 mm	0,310	2001603
AKK 160Y	160	1.20 mm	0,455	2001604
AKK 200Y	200	1.20 mm	0,635	2001605
AKK 300Y	300	1.20 mm	1,200	2001606
AKK 400Y	400	1.50 mm	2,440	2001607
AKK 500Y	500	1.50 mm	3,605	2001608
AKK 600Y	600	1.50 mm	4,995	2001609

AKK 100- Y

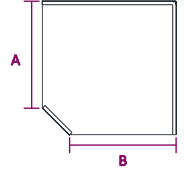

R300

Sipariş Kodu Order Code	W (mm)	T (mm)	Ağırlık (kg/ad) Weight (kg/pcs)	Barkod Kodu Barcode Code
AKK 050Y	50	1.20 mm	0,132	2001611
AKK 100Y	100	1.20 mm	0,270	2001612
AKK 120Y	120	1.20 mm	0,341	2001613
AKK 160Y	160	1.20 mm	0,501	2001614
AKK 200Y	200	1.20 mm	0,699	2001615
AKK 300Y	300	1.20 mm	1,320	2001616
AKK 400Y	400	1.50 mm	2,684	2001617
AKK 500Y	500	1.50 mm	3,966	2001618
AKK 600Y	600	1.50 mm	5,495	2001619

Dönüşlerde "A-B" ölçüleri esit olarak üretilmektedir. İsteğe bağlı olarak farklı ölçülerde üretim yapılır. Bends are produced same dimension for "A-B" as well as we can produce special dimensions regarding your inquiry.

R450

Sipariş Kodu Order Code	W (mm)	T (mm)	Ağırlık (kg/ad) Weight (kg/pcs)	Barkod Kodu Barcode Code
AKK 050Y	50	1.20 mm	0,145	2001621
AKK 100Y	100	1.20 mm	0,296	2001622
AKK 120Y	120	1.20 mm	0,375	2001623
AKK 160Y	160	1.20 mm	0,551	2001624
AKK 200Y	200	1.20 mm	0,768	2001625
AKK 300Y	300	1.20 mm	1,452	2001626
AKK 400Y	400	1.50 mm	2,952	2001627
AKK 500Y	500	1.50 mm	4,362	2001628
AKK 600Y	600	1.50 mm	6,044	2001629

R600

Sipariş Kodu Order Code	W (mm)	T (mm)	Ağırlık (kg/ad) Weight (kg/pcs)	Barkod Kodu Barcode Code
AKK 050Y	50	1.20 mm	0,160	2001631
AKK 100Y	100	1.20 mm	0,326	2001632
AKK 120Y	120	1.20 mm	0,413	2001633
AKK 160Y	160	1.20 mm	0,606	2001634
AKK 200Y	200	1.20 mm	0,845	2001635
AKK 300Y	300	1.20 mm	1,597	2001636
AKK 400Y	400	1.50 mm	3,248	2001637
AKK 500Y	500	1.50 mm	4,798	2001638
AKK 600Y	600	1.50 mm	6,648	2001639

W = GENİŞLİK = WIDTH / T = KALINLIK = THICKNESS

ARTIM METAL ELEKTRİK A.Ş.

* Farklı kalınlık ve ölçülerde üretim yapılabılır.
* Malzeme ağırlıkları yaklaşık değerlerdir, ± %10 değişiklik gösterebilir.
* Malzeme kalınlık toleransı ± %10 dur.
* Lütfen siparişlerinizde sipariş kodu veya ürün kodu ve Kaplama şeklini belirtiniz.

* We can produce cable trays different thickness and dimensions
* Cable trays are shown approximately weight, they could change ± %10 difference.
* Cable trays thickness tolerances are shown ± %10 .
* Please indicate order code and coating type in your orders.

AKK SERIES

KABLO KANALI 90° YATAY DÖNÜS KAPAGI

CABLE TRAY 90° BEND COVERS

SICAK DALDIRMA (SD)

HOT DIP GALVANIZED (HDG)

TS EN ISO 1461



90°

Sipariş Kodu Order Code	W (mm)	T (mm)	Ağırlık (kg/ad) Weight (kg/pcs)	Barkod Kodu Barcode Code
AKK 050Y	50	1.20 mm	0,160	2001601
AKK 100Y	100	1.20 mm	0,345	2001602
AKK 120Y	120	1.20 mm	0,435	2001603
AKK 160Y	160	1.20 mm	0,650	2001604
AKK 200Y	200	1.20 mm	0,900	2001605
AKK 300Y	300	1.20 mm	1,720	2001606
AKK 400Y	400	1.50 mm	3,730	2001607
AKK 500Y	500	1.50 mm	5,515	2001608
AKK 600Y	600	1.50 mm	7,645	2001609

AKK 100- Y

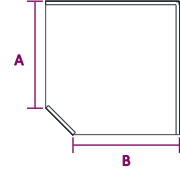

R300

Sipariş Kodu Order Code	W (mm)	T (mm)	Ağırlık (kg/ad) Weight (kg/pcs)	Barkod Kodu Barcode Code
AKK 050Y	50	1.20 mm	0,176	2001611
AKK 100Y	100	1.20 mm	0,380	2001612
AKK 120Y	120	1.20 mm	0,479	2001613
AKK 160Y	160	1.20 mm	0,715	2001614
AKK 200Y	200	1.20 mm	0,990	2001615
AKK 300Y	300	1.20 mm	1,892	2001616
AKK 400Y	400	1.50 mm	4,103	2001617
AKK 500Y	500	1.50 mm	6,067	2001618
AKK 600Y	600	1.50 mm	8,410	2001619

Dönüşlerde "A-B" ölçüleri eşit olarak üretilmektedir. İsteğe bağlı olarak farklı ölçülerde üretim yapılır. Bends are produced same dimension for "A-B" as well as we can produce special dimensions regarding your inquiry.

R450

Sipariş Kodu Order Code	W (mm)	T (mm)	Ağırlık (kg/ad) Weight (kg/pcs)	Barkod Kodu Barcode Code
AKK 050Y	50	1.20 mm	0,194	2001621
AKK 100Y	100	1.20 mm	0,417	2001622
AKK 120Y	120	1.20 mm	0,526	2001623
AKK 160Y	160	1.20 mm	0,787	2001624
AKK 200Y	200	1.20 mm	1,089	2001625
AKK 300Y	300	1.20 mm	2,081	2001626
AKK 400Y	400	1.50 mm	4,513	2001627
AKK 500Y	500	1.50 mm	6,673	2001628
AKK 600Y	600	1.50 mm	9,250	2001629

R600

Sipariş Kodu Order Code	W (mm)	T (mm)	Ağırlık (kg/ad) Weight (kg/pcs)	Barkod Kodu Barcode Code
AKK 050Y	50	1.20 mm	0,213	2001631
AKK 100Y	100	1.20 mm	0,459	2001632
AKK 120Y	120	1.20 mm	0,579	2001633
AKK 160Y	160	1.20 mm	0,865	2001634
AKK 200Y	200	1.20 mm	1,198	2001635
AKK 300Y	300	1.20 mm	2,289	2001636
AKK 400Y	400	1.50 mm	4,965	2001637
AKK 500Y	500	1.50 mm	7,340	2001638
AKK 600Y	600	1.50 mm	10,175	2001639

W = GENİŞLİK = WIDTH / T = KALINLIK = THICKNESS

* Farklı kalınlık ve ölçülerde üretim yapılabılır.
* Malzeme ağırlıkları yaklaşık değerlerdir, ± %10 değişiklik gösterebilir.
* Malzeme kalınlık toleransı ± %10 dur.
* Lütfen siparişlerinizde sipariş kodu veya ürün kodu ve Kaplama şeklini belirtiniz.

* We can produce cable trays different thickness and dimensions
* Cable trays are shown approximately weight, they could change ± %10 difference.
* Cable trays thickness tolerances are shown ± %10 .
* Please indicate order code and coating type in your orders.

AKK SERIES

KABLO KANALI T BAGLANTI KAPAKLARI

CABLE TRAY T BEND COVERS

PREGALVANİZ (PG)
PREGALVANIZED (PG)
TS EN 10346



T

Sipariş Kodu Order Code	W (mm)	T (mm)	Ağırlık (kg/ad) Weight (kg/pcs)	Barkod Kodu Barcode Code
AKK 050T	50	1.20 mm	0,140	2001651
AKK 100T	100	1.20 mm	0,290	2001652
AKK 120T	120	1.20 mm	0,360	2001653
AKK 160T	160	1.20 mm	0,530	2001654
AKK 200T	200	1.20 mm	0,775	2001655
AKK 300T	300	1.20 mm	1,355	2001656
AKK 400T	400	1.50 mm	2,715	2001657
AKK 500T	500	1.50 mm	3,975	2001658
AKK 600T	600	1.50 mm	5,465	2001659

R300

Sipariş Kodu Order Code	W (mm)	T (mm)	Ağırlık (kg/ad) Weight (kg/pcs)	Barkod Kodu Barcode Code
AKK 050T	50	1.20 mm	0,154	2001660
AKK 100T	100	1.20 mm	0,319	2001661
AKK 120T	120	1.20 mm	0,396	2001662
AKK 160T	160	1.20 mm	0,583	2001663
AKK 200T	200	1.20 mm	0,853	2001664
AKK 300T	300	1.20 mm	1,491	2001665
AKK 400T	400	1.50 mm	2,987	2001666
AKK 500T	500	1.50 mm	4,373	2001667
AKK 600T	600	1.50 mm	6,012	2001668

R450

Sipariş Kodu Order Code	W (mm)	T (mm)	Ağırlık (kg/ad) Weight (kg/pcs)	Barkod Kodu Barcode Code
AKK 050T	50	1.20 mm	0,169	2001669
AKK 100T	100	1.20 mm	0,351	2001670
AKK 120T	120	1.20 mm	0,436	2001671
AKK 160T	160	1.20 mm	0,641	2001672
AKK 200T	200	1.20 mm	0,938	2001673
AKK 300T	300	1.20 mm	1,640	2001674
AKK 400T	400	1.50 mm	3,285	2001675
AKK 500T	500	1.50 mm	4,810	2001676
AKK 600T	600	1.50 mm	6,613	2001677

R600

Sipariş Kodu Order Code	W (mm)	T (mm)	Ağırlık (kg/ad) Weight (kg/pcs)	Barkod Kodu Barcode Code
AKK 050T	50	1.20 mm	0,186	2001678
AKK 100T	100	1.20 mm	0,386	2001679
AKK 120T	120	1.20 mm	0,479	2001680
AKK 160T	160	1.20 mm	0,705	2001681
AKK 200T	200	1.20 mm	1,032	2001682
AKK 300T	300	1.20 mm	1,804	2001683
AKK 400T	400	1.50 mm	3,614	2001684
AKK 500T	500	1.50 mm	5,291	2001685
AKK 600T	600	1.50 mm	7,274	2001686

W = GENİŞLİK = WIDTH / T = KALINLIK = THICKNESS

AKK 100- T

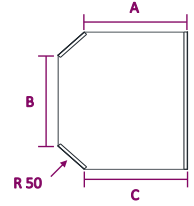

Dönüşlerde "A-B-C" ölçüleri esit olarak üretilmektedir. İsteğe bağlı olarak farklı ölçülerde üretim yapılır. Bends are produced same dimension for "A-B-C" as well as we can produce special dimensions regarding your inquiry.

ARTIM METAL ELEKTRİK A.Ş.

* Farklı kalınlık ve ölçülerde üretim yapılabılır.
* Malzeme ağırlıkları yaklaşık değerlerdir, ± %10 değişiklik gösterebilir.
* Malzeme kalınlık toleransı ± %10 dur.
* Lütfen siparişlerinizde sipariş kodu veya ürün kodu ve Kaplama şeklini belirtiniz.

* We can produce cable trays different thickness and dimensions
* Cable trays are shown approximately weight, they could change ± %10 difference.
* Cable trays thickness tolerances are shown ± %10 .
* Please indicate order code and coating type in your orders.

AKK SERIES

KABLO KANALI T BAĞLANTI KAPAKLARI

CABLE TRAY T BEND COVERS

SICAK DALDIRMA (SD)

HOT DIP GALVANIZED (HDG)

TS EN ISO 1461

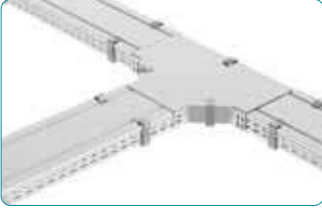

Sipariş Kodu Order Code	W (mm)	T (mm)	Ağırlık (kg/ad) Weight (kg/pcs)	Barkod Kodu Barcode Code
AKK 050T	50	1.20 mm	0,215	2001651
AKK 100T	100	1.20 mm	0,425	2001652
AKK 120T	120	1.20 mm	0,525	2001653
AKK 160T	160	1.20 mm	0,755	2001654
AKK 200T	200	1.20 mm	1,030	2001655
AKK 300T	300	1.20 mm	1,900	2001656
AKK 400T	400	1.50 mm	4,040	2001657
AKK 500T	500	1.50 mm	5,895	2001658
AKK 600T	600	1.50 mm	8,090	2001659

R300

Sipariş Kodu Order Code	W (mm)	T (mm)	Ağırlık (kg/ad) Weight (kg/pcs)	Barkod Kodu Barcode Code
AKK 050T	50	1.20 mm	0,237	2001660
AKK 100T	100	1.20 mm	0,468	2001661
AKK 120T	120	1.20 mm	0,578	2001662
AKK 160T	160	1.20 mm	0,831	2001663
AKK 200T	200	1.20 mm	1,133	2001664
AKK 300T	300	1.20 mm	2,090	2001665
AKK 400T	400	1.50 mm	4,444	2001666
AKK 500T	500	1.50 mm	6,485	2001667
AKK 600T	600	1.50 mm	8,899	2001668

R450

Sipariş Kodu Order Code	W (mm)	T (mm)	Ağırlık (kg/ad) Weight (kg/pcs)	Barkod Kodu Barcode Code
AKK 050T	50	1.20 mm	0,260	2001669
AKK 100T	100	1.20 mm	0,514	2001670
AKK 120T	120	1.20 mm	0,635	2001671
AKK 160T	160	1.20 mm	0,914	2001672
AKK 200T	200	1.20 mm	1,246	2001673
AKK 300T	300	1.20 mm	2,299	2001674
AKK 400T	400	1.50 mm	4,888	2001675
AKK 500T	500	1.50 mm	7,133	2001676
AKK 600T	600	1.50 mm	9,789	2001677

R600

Sipariş Kodu Order Code	W (mm)	T (mm)	Ağırlık (kg/ad) Weight (kg/pcs)	Barkod Kodu Barcode Code
AKK 050T	50	1.20 mm	0,286	2001678
AKK 100T	100	1.20 mm	0,566	2001679
AKK 120T	120	1.20 mm	0,699	2001680
AKK 160T	160	1.20 mm	1,005	2001681
AKK 200T	200	1.20 mm	1,371	2001682
AKK 300T	300	1.20 mm	2,529	2001683
AKK 400T	400	1.50 mm	5,377	2001684
AKK 500T	500	1.50 mm	7,846	2001685
AKK 600T	600	1.50 mm	10,768	2001686

W = GENİŞLİK = WIDTH / T = KALINLIK = THICKNESS

AKK 100- T

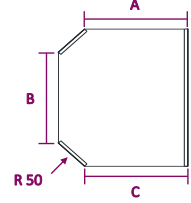

Dönüşlerde "A-B-C" ölçüleri esit olarak üretilmektedir. İsteğe bağlı olarak farklı ölçülerde üretim yapılır.
Bends are produced same dimension for "A-B-C" as well as we can produce special dimensions regarding your inquiry.

* Farklı kalınlık ve ölçülerde üretim yapılabılır.
* Malzeme ağırlıkları yaklaşık değerlerdir, ± %10 değişiklik gösterebilir.
* Malzeme kalınlık toleransı ± %10 dur.
* Lütfen siparişlerinizde sipariş kodu veya ürün kodu ve Kaplama şeklini belirtiniz.

* We can produce cable trays different thickness and dimensions
* Cable trays are shown approximately weight, they could change ± %10 difference.
* Cable trays thickness tolerances are shown ± %10 .
* Please indicate order code and coating type in your orders.

AKK SERIES

KABLO KANALI DÖRTLÜ BAĞLANTI KAPAKLARI

CABLE TRAY FOUR WAY CROSSING COVERS

PREGALVANİZ (PG)
PREGALVANIZED (PG)
TS EN 10346



4LÜ

Sipariş Kodu Order Code	W (mm)	T (mm)	Ağırlık (kg/ad) Weight (kg/pcs)	Barkod Kodu Barcode Code
AKK 050D	50	1.20 mm	0,170	2001701
AKK 100D	100	1.20 mm	0,340	2001702
AKK 120D	120	1.20 mm	0,410	2001703
AKK 160D	160	1.20 mm	0,595	2001704
AKK 200D	200	1.20 mm	0,805	2001705
AKK 300D	300	1.20 mm	1,465	2001706
AKK 400D	400	1.50 mm	2,895	2001707
AKK 500D	500	1.50 mm	4,190	2001708
AKK 600D	600	1.50 mm	5,725	2001709

R300

Sipariş Kodu Order Code	W (mm)	T (mm)	Ağırlık (kg/ad) Weight (kg/pcs)	Barkod Kodu Barcode Code
AKK 050D	50	1.20 mm	0,187	2001710
AKK 100D	100	1.20 mm	0,374	2001711
AKK 120D	120	1.20 mm	0,451	2001712
AKK 160D	160	1.20 mm	0,655	2001713
AKK 200D	200	1.20 mm	0,886	2001714
AKK 300D	300	1.20 mm	1,612	2001715
AKK 400D	400	1.50 mm	3,185	2001716
AKK 500D	500	1.50 mm	4,609	2001717
AKK 600D	600	1.50 mm	6,298	2001718

R450

Sipariş Kodu Order Code	W (mm)	T (mm)	Ağırlık (kg/ad) Weight (kg/pcs)	Barkod Kodu Barcode Code
AKK 050D	50	1.20 mm	0,206	2001719
AKK 100D	100	1.20 mm	0,411	2001720
AKK 120D	120	1.20 mm	0,496	2001721
AKK 160D	160	1.20 mm	0,720	2001722
AKK 200D	200	1.20 mm	0,974	2001723
AKK 300D	300	1.20 mm	1,773	2001724
AKK 400D	400	1.50 mm	3,503	2001725
AKK 500D	500	1.50 mm	5,070	2001726
AKK 600D	600	1.50 mm	6,927	2001727

R600

Sipariş Kodu Order Code	W (mm)	T (mm)	Ağırlık (kg/ad) Weight (kg/pcs)	Barkod Kodu Barcode Code
AKK 050D	50	1.20 mm	0,226	2001728
AKK 100D	100	1.20 mm	0,453	2001729
AKK 120D	120	1.20 mm	0,546	2001730
AKK 160D	160	1.20 mm	0,792	2001731
AKK 200D	200	1.20 mm	1,071	2001732
AKK 300D	300	1.20 mm	1,950	2001733
AKK 400D	400	1.50 mm	3,853	2001734
AKK 500D	500	1.50 mm	5,577	2001735
AKK 600D	600	1.50 mm	7,620	2001736

W = GENİŞLİK = WIDTH / T = KALINLIK = THICKNESS

AKK 100- D

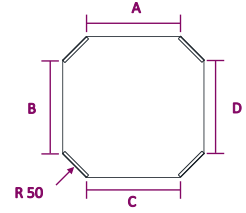

Dönüşlerde "A-B-C-D" ölçüleri esit olarak üretilmektedir. İsteğe bağlı olarak farklı ölçülerde üretim yapılır. Bends are produced same dimension for "A-B-C-D" as well as we can produce special dimensions regarding your inquiry.

ARTIM METAL ELEKTRİK A.Ş.

* Farklı kalınlık ve ölçülerde üretim yapılabılır.
* Malzeme ağırlıkları yaklaşık değerlerdir, ± %10 değişiklik gösterebilir.
* Malzeme kalınlık toleransı ± %10 dur.
* Lütfen siparişlerinizde sipariş kodu veya ürün kodu ve Kaplama şeklini belirtiniz.

* We can produce cable trays different thickness and dimensions
* Cable trays are shown approximately weight, they could change ± %10 difference.
* Cable trays thickness tolerances are shown ± %10 .
* Please indicate order code and coating type in your orders.

AKK SERIES

KABLO KANALI DÖRTLÜ BAĞLANTI KAPAKLARI

CABLE TRAY FOUR WAY CROSSING COVERS

SICAK DALDIRMA (SD)
HOT DIP GALVANIZED (HDG)
TS EN ISO 1461



4LÜ

Sipariş Kodu Order Code	W (mm)	T (mm)	Ağırlık (kg/ad) Weight (kg/pcs)	Barkod Kodu Barcode Code
AKK 050D	50	1.20 mm	0,280	2001701
AKK 100D	100	1.20 mm	0,515	2001702
AKK 120D	120	1.20 mm	0,625	2001703
AKK 160D	160	1.20 mm	0,875	2001704
AKK 200D	200	1.20 mm	1,175	2001705
AKK 300D	300	1.20 mm	2,095	2001706
AKK 400D	400	1.50 mm	2,790	2001707
AKK 500D	500	1.50 mm	4,365	2001708
AKK 600D	600	1.50 mm	6,290	2001709

R300

Sipariş Kodu Order Code	W (mm)	T (mm)	Ağırlık (kg/ad) Weight (kg/pcs)	Barkod Kodu Barcode Code
AKK 050D	50	1.20 mm	0,308	2001710
AKK 100D	100	1.20 mm	0,567	2001711
AKK 120D	120	1.20 mm	0,688	2001712
AKK 160D	160	1.20 mm	0,963	2001713
AKK 200D	200	1.20 mm	1,293	2001714
AKK 300D	300	1.20 mm	2,305	2001715
AKK 400D	400	1.50 mm	3,069	2001716
AKK 500D	500	1.50 mm	4,802	2001717
AKK 600D	600	1.50 mm	6,919	2001718

R450

Sipariş Kodu Order Code	W (mm)	T (mm)	Ağırlık (kg/ad) Weight (kg/pcs)	Barkod Kodu Barcode Code
AKK 050D	50	1.20 mm	0,339	2001719
AKK 100D	100	1.20 mm	0,623	2001720
AKK 120D	120	1.20 mm	0,756	2001721
AKK 160D	160	1.20 mm	1,059	2001722
AKK 200D	200	1.20 mm	1,422	2001723
AKK 300D	300	1.20 mm	2,535	2001724
AKK 400D	400	1.50 mm	3,376	2001725
AKK 500D	500	1.50 mm	5,282	2001726
AKK 600D	600	1.50 mm	7,611	2001727

R600

Sipariş Kodu Order Code	W (mm)	T (mm)	Ağırlık (kg/ad) Weight (kg/pcs)	Barkod Kodu Barcode Code
AKK 050D	50	1.20 mm	0,373	2001728
AKK 100D	100	1.20 mm	0,685	2001729
AKK 120D	120	1.20 mm	0,832	2001730
AKK 160D	160	1.20 mm	1,165	2001731
AKK 200D	200	1.20 mm	1,564	2001732
AKK 300D	300	1.20 mm	2,788	2001733
AKK 400D	400	1.50 mm	3,713	2001734
AKK 500D	500	1.50 mm	5,810	2001735
AKK 600D	600	1.50 mm	8,372	2001736

W = GENİŞLİK = WIDTH / T = KALINLIK = THICKNESS

AKK 100- D

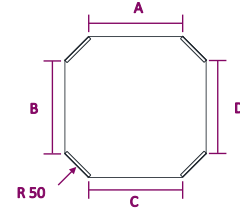

Dönüşlerde "A-B-C-D" ölçüleri esit olarak üretilmektedir. İsteğe bağlı olarak farklı ölçülerde üretim yapılır. Bends are produced same dimension for "A-B-C-D" as well as we can produce special dimensions regarding your inquiry.

* Farklı kalınlık ve ölçülerde üretim yapıla bilinir.
* Malzeme ağırlıkları yaklaşık değerlerdir, ± %10 değişiklik gösterebilir.
* Malzeme kalınlık toleransı ± %10 dur.
* Lütfen siparişlerinizde sipariş kodu veya ürün kodu ve Kaplama şeklini belirtiniz.

* We can produce cable trays different thickness and dimensions
* Cable trays are shown approximately weight, they could change ± %10 difference.
* Cable trays thickness tolerances are shown ± %10 .
* Please indicate order code and coating type in your orders.

AKK SERIES

45° DÖNÜS KAPAKLARI

45° BEND COVERS

PREGALVANİZ (PG)
PREGALVANIZED (PG)
TS EN 10346



Sipariş Kodu Order Code	W (mm)	T (mm)	Ağırlık (kg/ad) Weight (kg/pcs)	Barkod Kodu Barcode Code
AKK 050Y (45°)	50	1.20 mm	0,135	2001751
AKK 100Y (45°)	100	1.20 mm	0,265	2001752
AKK 120Y (45°)	120	1.20 mm	0,325	2001753
AKK 160Y (45°)	160	1.20 mm	0,460	2001754
AKK 200Y (45°)	200	1.20 mm	0,590	2001755
AKK 300Y (45°)	300	1.20 mm	0,955	2001756
AKK 400Y (45°)	400	1.50 mm	1,795	2001757
AKK 500Y (45°)	500	1.50 mm	2,470	2001758
AKK 600Y (45°)	600	1.50 mm	3,255	2001759

W = GENİŞLİK = WIDTH / T = KALINLIK = THICKNESS

PG

AKK 100 Y (45°)

Kanal Tipi Genişlik Modül
Type Width Module

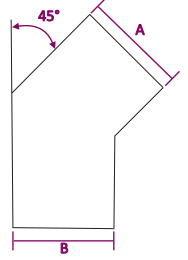

SICAK DALDIRMA (SD)
HOT DIP GALVANIZED (SD)
TS EN ISO 1461



Sipariş Kodu Order Code	W (mm)	T (mm)	Ağırlık (kg/ad) Weight (kg/pcs)	Barkod Kodu Barcode Code
AKK 050Y (45°)	50	1.20 mm	0,215	2001751
AKK 100Y (45°)	100	1.20 mm	0,390	2001752
AKK 120Y (45°)	120	1.20 mm	0,480	2001753
AKK 160Y (45°)	160	1.20 mm	0,555	2001754
AKK 200Y (45°)	200	1.20 mm	0,835	2001755
AKK 300Y (45°)	300	1.20 mm	2,230	2001756
AKK 400Y (45°)	400	1.50 mm	4,200	2001757
AKK 500Y (45°)	500	1.50 mm	5,560	2001758
AKK 600Y (45°)	600	1.50 mm	7,075	2001759

W = GENİŞLİK = WIDTH / T = KALINLIK = THICKNESS

SD

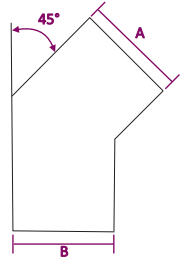

ARTIM METAL ELEKTRİK A.Ş.

- * Farklı kalınlık ve ölçülerde üretim yapılabilmektedir.
- * Malzeme ağırlıkları yaklaşık değerlerdir, \pm %10 değişiklik gösterebilir.
- * Malzeme kalınlık toleransı \pm %10 dur.
- * Lütfen siparişlerinizde sipariş kodu veya ürün kodu ve kaplama şeklini belirtiniz.

- * We can produce cable trays different thickness and dimensions
- * Cable trays are shown approximately weight, they could change \pm %10 difference.
- * Cable trays thickness tolerances are shown \pm %10 .
- * Please indicate order code and coating type in your orders.

AKK SERIES

İÇ-DİS BÜKEY KAPAKLARI (HAREKETLİ)

ADJUSTABLE INSIDE-OUTSIDE VERTICAL BENDS COVERS

PREGALVANİZ (PG)
PREGALVANIZED (PG)
TS EN 10346



Sipariş Kodu Order Code	W (mm)	T (mm)	Ağırlık (kg/ad) Weight (kg/pcs)	Barkod Kodu Barcode Code
AKK 050B	50	1.20 mm	0,565	2001781
AKK 100B	100	1.20 mm	0,970	2001782
AKK 120B	120	1.20 mm	1,130	2001783
AKK 160B	160	1.20 mm	1,455	2001784
AKK 200B	200	1.20 mm	1,775	2001785
AKK 300B	300	1.20 mm	2,585	2001786
AKK 400B	400	1.50 mm	4,520	2001787
AKK 500B	500	1.50 mm	5,595	2001788
AKK 600B	600	1.50 mm	6,670	2001789

W = GENİŞLİK = WIDTH / T = KALINLIK = THICKNESS

PG

AKK 100- B

Kanal Tipi Genişlik Modül
Type Width Module

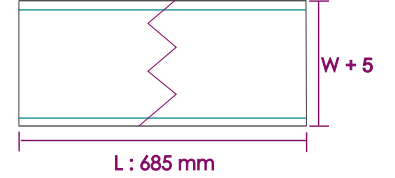

SICAK DALDIRMA (SD)
HOT DIP GALVANIZED (SD)
TS EN ISO 1461



Sipariş Kodu Order Code	W (mm)	T (mm)	Ağırlık (kg/ad) Weight (kg/pcs)	Barkod Kodu Barcode Code
AKK 050B	50	1.20 mm	0,625	2001781
AKK 100B	100	1.20 mm	1,065	2001782
AKK 120B	120	1.20 mm	1,245	2001783
AKK 160B	160	1.20 mm	1,595	2001784
AKK 200B	200	1.20 mm	1,955	2001785
AKK 300B	300	1.20 mm	2,840	2001786
AKK 400B	400	1.50 mm	4,970	2001787
AKK 500B	500	1.50 mm	6,155	2001788
AKK 600B	600	1.50 mm	7,335	2001789

W = GENİŞLİK = WIDTH / T = KALINLIK = THICKNESS

SD

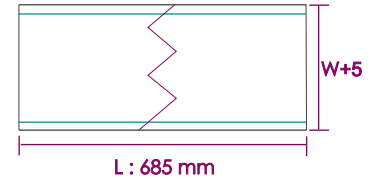

* Farklı kalınlık ve ölçülerde üretim yapıla bilinir.
* Malzeme ağırlıkları yaklaşık değerlerdir, \pm %10 değişiklik gösterebilir.
* Malzeme kalınlık toleransı \pm %10 dur.
* Lütfen siparişlerinizde sipariş kodu veya ürün kodu ve kaplama şeklini belirtiniz.

* We can produce cable trays different thickness and dimensions
* Cable trays are shown approximately weight, they could change \pm %10 difference.
* Cable trays thickness tolerances are shown \pm %10 .
* Please indicate order code and coating type in your orders.

AKK SERIES

İÇ BÜKEY DÖNÜS KAPAKLARI (SABİT)

CONSTANT INSIDE VERTICAL BENDS COVERS

PREGALVANİZ (PG)
PREGALVANIZED (PG)
TS EN 10346



H40

Sipariş Kodu Order Code	W (mm)	T (mm)	Ağırlık (kg/ad) Weight (kg/pcs)	Barkod Kodu Barcode Code
40 AKK 050B S1	50	1.50 mm	0,440	2001801
40 AKK 100B S1	100	1.50 mm	0,755	2001802
40 AKK 120B S1	120	1.50 mm	0,880	2001803
40 AKK 160B S1	160	1.50 mm	1,130	2001804
40 AKK 200B S1	200	1.50 mm	1,385	2001805
40 AKK 300B S1	300	1.50 mm	2,010	2001806
40 AKK 400B S1	400	2.00 mm	3,520	2001807
40 AKK 500B S1	500	2.00 mm	4,360	2001808
40 AKK 600B S1	600	2.00 mm	5,195	2001809

H50

Sipariş Kodu Order Code	W (mm)	T (mm)	Ağırlık (kg/ad) Weight (kg/pcs)	Barkod Kodu Barcode Code
50 AKK 050B S1	50	1.50 mm	0,462	2001821
50 AKK 100B S1	100	1.50 mm	0,793	2001822
50 AKK 120B S1	120	1.50 mm	0,924	2001823
50 AKK 160B S1	160	1.50 mm	1,187	2001824
50 AKK 200B S1	200	1.50 mm	1,454	2001825
50 AKK 300B S1	300	1.50 mm	2,111	2001826
50 AKK 400B S1	400	2.00 mm	3,696	2001827
50 AKK 500B S1	500	2.00 mm	4,578	2001828
50 AKK 600B S1	600	2.00 mm	5,455	2001829

H60

Sipariş Kodu Order Code	W (mm)	T (mm)	Ağırlık (kg/ad) Weight (kg/pcs)	Barkod Kodu Barcode Code
60 AKK 050B S1	50	1.50 mm	0,485	2001841
60 AKK 100B S1	100	1.50 mm	0,832	2001842
60 AKK 120B S1	120	1.50 mm	0,970	2001843
60 AKK 160B S1	160	1.50 mm	1,246	2001844
60 AKK 200B S1	200	1.50 mm	1,527	2001845
60 AKK 300B S1	300	1.50 mm	2,216	2001846
60 AKK 400B S1	400	2.00 mm	3,881	2001847
60 AKK 500B S1	500	2.00 mm	4,807	2001848
60 AKK 600B S1	600	2.00 mm	5,727	2001849

H100

Sipariş Kodu Order Code	W (mm)	T (mm)	Ağırlık (kg/ad) Weight (kg/pcs)	Barkod Kodu Barcode Code
100 AKK 050B S1	50	1.50 mm	0,534	2001861
100 AKK 100B S1	100	1.50 mm	0,916	2001862
100 AKK 120B S1	120	1.50 mm	1,067	2001863
100 AKK 160B S1	160	1.50 mm	1,370	2001864
100 AKK 200B S1	200	1.50 mm	1,680	2001865
100 AKK 300B S1	300	1.50 mm	2,438	2001866
100 AKK 400B S1	400	2.00 mm	4,269	2001867
100 AKK 500B S1	500	2.00 mm	5,288	2001868
100 AKK 600B S1	600	2.00 mm	6,300	2001869

W = GENİŞLİK = WIDTH / T = KALINLIK = THICKNESS

AKK 100 B S1

Kanal Tipi Genişlik Modül
Type Width Module

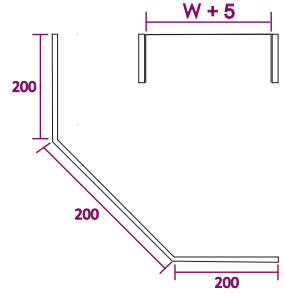

ARTIM METAL ELEKTRİK A.Ş.

* Farklı kalınlık ve ölçülerde üretim yapılabılır.
* Malzeme ağırlıkları yaklaşık değerlerdir, \pm %10 değişiklik gösterebilir.
* Malzeme kalınlık toleransı \pm %10 dur.
* Lütfen siparişlerinizde sipariş kodu veya ürün kodu ve Kaplama şeklini belirtiniz.

* We can produce cable trays different thickness and dimensions
* Cable trays are shown approximately weight, they could change \pm %10 difference.
* Cable trays thickness tolerances are shown \pm %10 .
* Please indicate order code and coating type in your orders.

AKK SERIES

İÇ BÜKEY DÖNÜS KAPAKLARI (SABIT)

CONSTANT INSIDE VERTICAL BENDS COVERS

SICAK DALDIRMA (SD)

HOT DIP GALVANIZED (HDG)

TS EN ISO 1461



H40

Sipariş Kodu Order Code	W (mm)	T (mm)	Ağırlık (kg/ad) Weight (kg/pcs)	Barkod Kodu Barcode Code
40 AKK 050B S1	50	1.50 mm	0,485	2001801
40 AKK 100B S1	100	1.50 mm	0,830	2001802
40 AKK 120B S1	120	1.50 mm	0,970	2001803
40 AKK 160B S1	160	1.50 mm	1,245	2001804
40 AKK 200B S1	200	1.50 mm	1,520	2001805
40 AKK 300B S1	300	1.50 mm	2,215	2001806
40 AKK 400B S1	400	2.00 mm	3,875	2001807
40 AKK 500B S1	500	2.00 mm	4,795	2001808
40 AKK 600B S1	600	2.00 mm	5,720	2001809

H50

Sipariş Kodu Order Code	W (mm)	T (mm)	Ağırlık (kg/ad) Weight (kg/pcs)	Barkod Kodu Barcode Code
50 AKK 050B S1	50	1.50 mm	0,509	2001821
50 AKK 100B S1	100	1.50 mm	0,872	2001822
50 AKK 120B S1	120	1.50 mm	1,019	2001823
50 AKK 160B S1	160	1.50 mm	1,307	2001824
50 AKK 200B S1	200	1.50 mm	1,596	2001825
50 AKK 300B S1	300	1.50 mm	2,326	2001826
50 AKK 400B S1	400	2.00 mm	4,069	2001827
50 AKK 500B S1	500	2.00 mm	5,035	2001828
50 AKK 600B S1	600	2.00 mm	6,006	2001829

H60

Sipariş Kodu Order Code	W (mm)	T (mm)	Ağırlık (kg/ad) Weight (kg/pcs)	Barkod Kodu Barcode Code
60 AKK 050B S1	50	1.50 mm	0,535	2001841
60 AKK 100B S1	100	1.50 mm	0,915	2001842
60 AKK 120B S1	120	1.50 mm	1,069	2001843
60 AKK 160B S1	160	1.50 mm	1,373	2001844
60 AKK 200B S1	200	1.50 mm	1,676	2001845
60 AKK 300B S1	300	1.50 mm	2,442	2001846
60 AKK 400B S1	400	2.00 mm	4,272	2001847
60 AKK 500B S1	500	2.00 mm	5,286	2001848
60 AKK 600B S1	600	2.00 mm	6,306	2001849

H100

Sipariş Kodu Order Code	W (mm)	T (mm)	Ağırlık (kg/ad) Weight (kg/pcs)	Barkod Kodu Barcode Code
100 AKK 050B S1	50	1.50 mm	0,588	2001861
100 AKK 100B S1	100	1.50 mm	1,007	2001862
100 AKK 120B S1	120	1.50 mm	1,176	2001863
100 AKK 160B S1	160	1.50 mm	1,510	2001864
100 AKK 200B S1	200	1.50 mm	1,843	2001865
100 AKK 300B S1	300	1.50 mm	2,686	2001866
100 AKK 400B S1	400	2.00 mm	4,699	2001867
100 AKK 500B S1	500	2.00 mm	5,815	2001868
100 AKK 600B S1	600	2.00 mm	6,937	2001869

W = GENİŞLİK = WIDTH / T = KALINLIK = THICKNESS

AKK 100 B S1

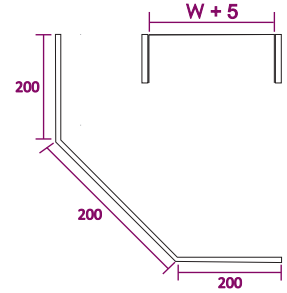

* Farklı kalınlık ve ölçülerde üretim yapıla bilinir.
* Malzeme ağırlıkları yaklaşık değerlerdir, \pm %10 değişiklik gösterebilir.
* Malzeme kalınlık toleransı \pm %10 dur.
* Lütfen siparişlerinizde sipariş kodu veya ürün kodu ve kaplama şeklini belirtiniz.

* We can produce cable trays different thickness and dimensions
* Cable trays are shown approximately weight, they could change \pm %10 difference.
* Cable trays thickness tolerances are shown \pm %10 .
* Please indicate order code and coating type in your orders.

AKK SERIES

DİS BÜKEY DÖNÜS KAPAKLARI (SABIT)

CONSTANT OUTSIDE VERTICAL BENDS COVERS

PREGALVANİZ (PG)
PREGALVANIZED (PG)
TS EN 10346



AKK 100 B S2

Kanal Tipi Genişlik Modül
Type Width Module

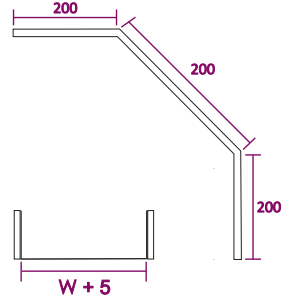

Sipariş Kodu Order Code	W (mm)	T (mm)	Ağırlık (kg/ad) Weight (kg/pcs)	Barkod Kodu Barcode Code
40 AKK 050B S2	50	1.50 mm	0,500	2001881
40 AKK 100B S2	100	1.50 mm	0,855	2001882
40 AKK 120B S2	120	1.50 mm	0,995	2001883
40 AKK 160B S2	160	1.50 mm	1,420	2001884
40 AKK 200B S2	200	1.50 mm	1,560	2001885
40 AKK 300B S2	300	1.50 mm	2,270	2001886
40 AKK 400B S2	400	2.00 mm	3,980	2001887
40 AKK 500B S2	500	2.00 mm	4,925	2001888
40 AKK 600B S2	600	2.00 mm	5,870	2001889

Sipariş Kodu Order Code	W (mm)	T (mm)	Ağırlık (kg/ad) Weight (kg/pcs)	Barkod Kodu Barcode Code
50 AKK 050B S2	50	1.50 mm	0,525	2001901
50 AKK 100B S2	100	1.50 mm	0,898	2001902
50 AKK 120B S2	120	1.50 mm	1,045	2001903
50 AKK 160B S2	160	1.50 mm	1,491	2001904
50 AKK 200B S2	200	1.50 mm	1,638	2001905
50 AKK 300B S2	300	1.50 mm	2,384	2001906
50 AKK 400B S2	400	2.00 mm	4,179	2001907
50 AKK 500B S2	500	2.00 mm	5,171	2001908
50 AKK 600B S2	600	2.00 mm	6,164	2001909

Sipariş Kodu Order Code	W (mm)	T (mm)	Ağırlık (kg/ad) Weight (kg/pcs)	Barkod Kodu Barcode Code
60 AKK 050B S2	50	1.50 mm	0,551	2001921
60 AKK 100B S2	100	1.50 mm	0,943	2001922
60 AKK 120B S2	120	1.50 mm	1,097	2001923
60 AKK 160B S2	160	1.50 mm	1,566	2001924
60 AKK 200B S2	200	1.50 mm	1,720	2001925
60 AKK 300B S2	300	1.50 mm	2,503	2001926
60 AKK 400B S2	400	2.00 mm	4,388	2001927
60 AKK 500B S2	500	2.00 mm	5,430	2001928
60 AKK 600B S2	600	2.00 mm	6,472	2001929

Sipariş Kodu Order Code	W (mm)	T (mm)	Ağırlık (kg/ad) Weight (kg/pcs)	Barkod Kodu Barcode Code
100 AKK 050B S2	50	1.50 mm	0,606	2001941
100 AKK 100B S2	100	1.50 mm	1,037	2001942
100 AKK 120B S2	120	1.50 mm	1,207	2001943
100 AKK 160B S2	160	1.50 mm	1,722	2001944
100 AKK 200B S2	200	1.50 mm	1,892	2001945
100 AKK 300B S2	300	1.50 mm	2,753	2001946
100 AKK 400B S2	400	2.00 mm	4,827	2001947
100 AKK 500B S2	500	2.00 mm	5,973	2001948
100 AKK 600B S2	600	2.00 mm	7,119	2001949

W = GENİŞLİK = WIDTH / T = KALINLIK = THICKNESS

ARTIM METAL ELEKTRİK A.Ş.

* Farklı kalınlık ve ölçülerde üretim yapılabılır.
* Malzeme ağırlıkları yaklaşık değerlerdir, ± %10 değişiklik gösterebilir.
* Malzeme kalınlık toleransı ± %10 dur.
* Lütfen siparişlerinizde sipariş kodu veya ürün kodu ve Kaplama şeklini belirtiniz.

* We can produce cable trays different thickness and dimensions
* Cable trays are shown approximately weight, they could change ± %10 difference.
* Cable trays thickness tolerances are shown ± %10 .
* Please indicate order code and coating type in your orders.

AKK SERIES

DİS BÜKEY DÖNÜS KAPAKLARI (SABIT)

CONSTANT OUTSIDE VERTICAL BENDS COVERS

SICAK DALDIRMA (SD)

HOT DIP GALVANIZED (HDG)

TS EN ISO 1461



H40

Sipariş Kodu Order Code	W (mm)	T (mm)	Ağırlık (kg/ad) Weight (kg/pcs)	Barkod Kodu Barcode Code
40 AKK 050B S2	50	1.50 mm	0,550	2001881
40 AKK 100B S2	100	1.50 mm	0,940	2001882
40 AKK 120B S2	120	1.50 mm	1,095	2001883
40 AKK 160B S2	160	1.50 mm	1,565	2001884
40 AKK 200B S2	200	1.50 mm	1,720	2001885
40 AKK 300B S2	300	1.50 mm	2,500	2001886
40 AKK 400B S2	400	2.00 mm	4,375	2001887
40 AKK 500B S2	500	2.00 mm	5,420	2001888
40 AKK 600B S2	600	2.00 mm	6,460	2001889

H50

Sipariş Kodu Order Code	W (mm)	T (mm)	Ağırlık (kg/ad) Weight (kg/pcs)	Barkod Kodu Barcode Code
50 AKK 050B S2	50	1.50 mm	0,578	2001901
50 AKK 100B S2	100	1.50 mm	0,987	2001902
50 AKK 120B S2	120	1.50 mm	1,150	2001903
50 AKK 160B S2	160	1.50 mm	1,643	2001904
50 AKK 200B S2	200	1.50 mm	1,806	2001905
50 AKK 300B S2	300	1.50 mm	2,625	2001906
50 AKK 400B S2	400	2.00 mm	4,594	2001907
50 AKK 500B S2	500	2.00 mm	5,691	2001908
50 AKK 600B S2	600	2.00 mm	6,783	2001909

H60

Sipariş Kodu Order Code	W (mm)	T (mm)	Ağırlık (kg/ad) Weight (kg/pcs)	Barkod Kodu Barcode Code
60 AKK 050B S2	50	1.50 mm	0,606	2001921
60 AKK 100B S2	100	1.50 mm	1,036	2001922
60 AKK 120B S2	120	1.50 mm	1,207	2001923
60 AKK 160B S2	160	1.50 mm	1,725	2001924
60 AKK 200B S2	200	1.50 mm	1,896	2001925
60 AKK 300B S2	300	1.50 mm	2,756	2001926
60 AKK 400B S2	400	2.00 mm	4,823	2001927
60 AKK 500B S2	500	2.00 mm	5,976	2001928
60 AKK 600B S2	600	2.00 mm	7,122	2001929

H100

Sipariş Kodu Order Code	W (mm)	T (mm)	Ağırlık (kg/ad) Weight (kg/pcs)	Barkod Kodu Barcode Code
100 AKK 050B S2	50	1.50 mm	0,667	2001941
100 AKK 100B S2	100	1.50 mm	1,140	2001942
100 AKK 120B S2	120	1.50 mm	1,328	2001943
100 AKK 160B S2	160	1.50 mm	1,898	2001944
100 AKK 200B S2	200	1.50 mm	2,086	2001945
100 AKK 300B S2	300	1.50 mm	3,032	2001946
100 AKK 400B S2	400	2.00 mm	5,306	2001947
100 AKK 500B S2	500	2.00 mm	6,573	2001948
100 AKK 600B S2	600	2.00 mm	7,834	2001949

W = GENİŞLİK = WIDTH / T = KALINLIK = THICKNESS

AKK 100 B S2

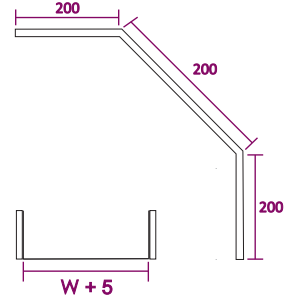

* Farklı kalınlık ve ölçülerde üretim yapıla bilinir.
* Malzeme ağırlıkları yaklaşık değerlerdir, ± %10 değişiklik gösterebilir.
* Malzeme kalınlık toleransı ± %10 dur.
* Lütfen siparişlerinizde sipariş kodu veya ürün kodu ve Kaplama şeklini belirtiniz.

* We can produce cable trays different thickness and dimensions
* Cable trays are shown approximately weight, they could change ± %10 difference.
* Cable trays thickness tolerances are shown ± %10 .
* Please indicate order code and coating type in your orders.

AKK SERIES

DIKEY & ORTADAN T BAGLANTI KAPAKLARI

VERTICAL & MIDDLE T CONNECTION COVERS

PREGALVANİZ (PG)
PREGALVANIZED (PG)
TS EN 10346



Sipariş Kodu Order Code	W (mm)	T (mm)	Ağırlık (kg/ad) Weight (kg/pcs)	Barkod Kodu Barcode Code
AKK 050DDO	50	1.50 mm	0,110	2001961
AKK 100DDO	100	1.50 mm	0,220	2001962
AKK 120DDO	120	1.50 mm	0,264	2001963
AKK 160DDO	160	1.50 mm	0,352	2001964
AKK 200DDO	200	1.50 mm	0,440	2001965
AKK 300DDO	300	1.50 mm	0,659	2001966
AKK 400DDO	400	2.00 mm	0,879	2001967
AKK 500DDO	500	2.00 mm	1,099	2001968
AKK 600DDO	600	2.00 mm	1,319	2001969

PG

AKK 100 Y (45°)

Kanal Tipi Genişlik Modül
Type Width Module

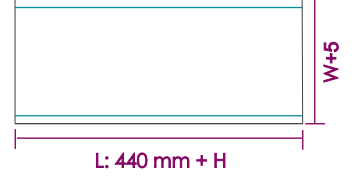

W = GENİŞLİK = WIDTH / T = KALINLIK = THICKNESS

SICAK DALDIRMA (SD)
HOT DIP GALVANIZED (SD)
TS EN ISO 1461



Sipariş Kodu Order Code	W (mm)	T (mm)	Ağırlık (kg/ad) Weight (kg/pcs)	Barkod Kodu Barcode Code
AKK 050DDO	50	1.50 mm	0,121	2001961
AKK 100DDO	100	1.50 mm	0,242	2001962
AKK 120DDO	120	1.50 mm	0,290	2001963
AKK 160DDO	160	1.50 mm	0,387	2001964
AKK 200DDO	200	1.50 mm	0,484	2001965
AKK 300DDO	300	1.50 mm	0,725	2001966
AKK 400DDO	400	2.00 mm	0,967	2001967
AKK 500DDO	500	2.00 mm	1,209	2001968
AKK 600DDO	600	2.00 mm	1,451	2001969

SD

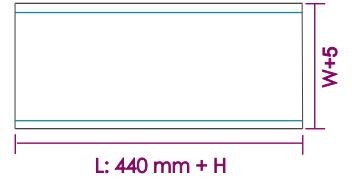

W = GENİŞLİK = WIDTH / T = KALINLIK = THICKNESS

ARTIM METAL ELEKTRİK A.Ş.

* Farklı kalınlık ve ölçülerde üretim yapılabılır.
* Malzeme ağırlıkları yaklaşık değerlerdir, \pm %10 değişiklik gösterebilir.
* Malzeme kalınlık toleransı \pm %10 dur.
* Lütfen siparişlerinizde sipariş kodu veya ürün kodu ve Kaplama şeklini belirtiniz.

* We can produce cable trays different thickness and dimensions
* Cable trays are shown approximately weight, they could change \pm %10 difference.
* Cable trays thickness tolerances are shown \pm %10 .
* Please indicate order code and coating type in your orders.

AKK SERIES

MERDIVEN 90° YATAY DÖNÜS KAPAKLARI

LADDER 90° BEND COVERS

SICAK DALDIRMA (SD)

HOT DIP GALVANIZED (HDG)

TS EN ISO 1461



90°

Sipariş Kodu Order Code	W (mm)	T (mm)	Ağırlık (kg/ad) Weight (kg/pcs)	Barkod Kodu Barcode Code
AMK 100Y	100	1.50 mm	1,008	2002101
AMK 200Y	200	1.50 mm	2,235	2002102
AMK 300Y	300	1.50 mm	3,722	2002103
AMK 400Y	400	2.00 mm	7,291	2002104
AMK 500Y	500	2.00 mm	9,966	2002105
AMK 600Y	600	2.00 mm	12,987	2002106
AMK 700Y	700	2.00 mm	16,770	2002107
AMK 800Y	800	2.00 mm	20,096	2002108
AMK 900Y	900	2.00 mm	23,144	2002109
AMK 1000Y	1.000	2.00 mm	26,574	2002108

AMK 100- Y

Kanal Tipi Genişlik Modül
Type Width Module

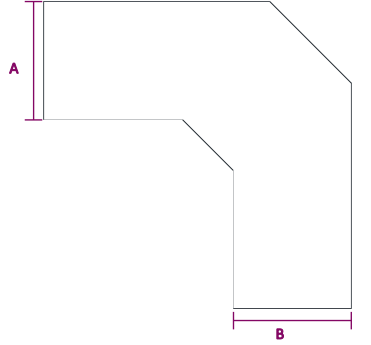

R300

Sipariş Kodu Order Code	W (mm)	T (mm)	Ağırlık (kg/ad) Weight (kg/pcs)	Barkod Kodu Barcode Code
AMK 100Y	100	1.50 mm	1,058	2002101
AMK 200Y	200	1.50 mm	2,347	2002102
AMK 300Y	300	1.50 mm	3,908	2002103
AMK 400Y	400	2.00 mm	7,656	2002104
AMK 500Y	500	2.00 mm	10,464	2002105
AMK 600Y	600	2.00 mm	13,636	2002106
AMK 700Y	700	2.00 mm	17,609	2002107
AMK 800Y	800	2.00 mm	21,101	2002108
AMK 900Y	900	2.00 mm	24,301	2002109
AMK 1000Y	1.000	2.00 mm	27,903	2002108

R450

Sipariş Kodu Order Code	W (mm)	T (mm)	Ağırlık (kg/ad) Weight (kg/pcs)	Barkod Kodu Barcode Code
AMK 100Y	100	1.50 mm	1,143	2002101
AMK 200Y	200	1.50 mm	2,534	2002102
AMK 300Y	300	1.50 mm	4,221	2002103
AMK 400Y	400	2.00 mm	8,268	2002104
AMK 500Y	500	2.00 mm	11,301	2002105
AMK 600Y	600	2.00 mm	14,727	2002106
AMK 700Y	700	2.00 mm	19,017	2002107
AMK 800Y	800	2.00 mm	22,789	2002108
AMK 900Y	900	2.00 mm	26,245	2002109
AMK 1000Y	1.000	2.00 mm	30,135	2002108

R600

Sipariş Kodu Order Code	W (mm)	T (mm)	Ağırlık (kg/ad) Weight (kg/pcs)	Barkod Kodu Barcode Code
AMK 100Y	100	1.50 mm	1,257	2002101
AMK 200Y	200	1.50 mm	2,788	2002102
AMK 300Y	300	1.50 mm	4,643	2002103
AMK 400Y	400	2.00 mm	9,095	2002104
AMK 500Y	500	2.00 mm	12,432	2002105
AMK 600Y	600	2.00 mm	16,200	2002106
AMK 700Y	700	2.00 mm	20,919	2002107
AMK 800Y	800	2.00 mm	25,068	2002108
AMK 900Y	900	2.00 mm	28,870	2002109
AMK 1000Y	1.000	2.00 mm	33,148	2002108

W = GENİŞLİK = WIDTH / T = KALINLIK = THICKNESS

* Farklı kalınlık ve ölçülerde üretim yapılabılır.
* Malzeme ağırlıkları yaklaşık değerlerdir, ± %10 değişiklik gösterebilir.
* Malzeme kalınlık toleransı ± %10 dur.
* Lütfen siparişlerinizde sipariş kodu veya ürün kodu ve kaplama şeklini belirtiniz.

* We can produce cable trays different thickness and dimensions
* Cable trays are shown approximately weight, they could change ± %10 difference.
* Cable trays thickness tolerances are shown ± %10 .
* Please indicate order code and coating type in your orders.

AKK SERIES

MERDIVEN T BAĞLANTI KAPAKLARI

LADDER T BEND COVERS

SICAK DALDIRMA (SD)
HOT DIP GALVANIZED (HDG)
TS EN ISO 1461



Sipariş Kodu Order Code	W (mm)	T (mm)	Ağırlık (kg/ad) Weight (kg/pcs)	Barkod Kodu Barcode Code
AMK 100T	100	1.50 mm	1,695	2002101
AMK 200T	200	1.50 mm	3,310	2002102
AMK 300T	300	1.50 mm	5,168	2002103
AMK 400T	400	2.00 mm	9,726	2002104
AMK 500T	500	2.00 mm	12,907	2002105
AMK 600T	600	2.00 mm	16,435	2002106
AMK 700T	700	2.00 mm	19,722	2002107
AMK 800T	800	2.00 mm	23,074	2002108
AMK 900T	900	2.00 mm	26,304	2002109
AMK 1000T	1.000	2.00 mm	29,197	2002108

Sipariş Kodu Order Code	W (mm)	T (mm)	Ağırlık (kg/ad) Weight (kg/pcs)	Barkod Kodu Barcode Code
AMK 100T	100	1.50 mm	1,780	2002101
AMK 200T	200	1.50 mm	3,476	2002102
AMK 300T	300	1.50 mm	5,426	2002103
AMK 400T	400	2.00 mm	10,212	2002104
AMK 500T	500	2.00 mm	13,552	2002105
AMK 600T	600	2.00 mm	17,257	2002106
AMK 700T	700	2.00 mm	20,708	2002107
AMK 800T	800	2.00 mm	24,228	2002108
AMK 900T	900	2.00 mm	27,619	2002109
AMK 1000T	1.000	2.00 mm	30,657	2002108

Sipariş Kodu Order Code	W (mm)	T (mm)	Ağırlık (kg/ad) Weight (kg/pcs)	Barkod Kodu Barcode Code
AMK 100T	100	1.50 mm	1,922	2002101
AMK 200T	200	1.50 mm	3,754	2002102
AMK 300T	300	1.50 mm	5,861	2002103
AMK 400T	400	2.00 mm	11,029	2002104
AMK 500T	500	2.00 mm	14,637	2002105
AMK 600T	600	2.00 mm	18,637	2002106
AMK 700T	700	2.00 mm	22,365	2002107
AMK 800T	800	2.00 mm	26,166	2002108
AMK 900T	900	2.00 mm	29,829	2002109
AMK 1000T	1.000	2.00 mm	33,109	2002108

Sipariş Kodu Order Code	W (mm)	T (mm)	Ağırlık (kg/ad) Weight (kg/pcs)	Barkod Kodu Barcode Code
AMK 100T	100	1.50 mm	2,114	2002101
AMK 200T	200	1.50 mm	4,129	2002102
AMK 300T	300	1.50 mm	6,447	2002103
AMK 400T	400	2.00 mm	12,132	2002104
AMK 500T	500	2.00 mm	16,100	2002105
AMK 600T	600	2.00 mm	20,501	2002106
AMK 700T	700	2.00 mm	24,601	2002107
AMK 800T	800	2.00 mm	28,783	2002108
AMK 900T	900	2.00 mm	32,812	2002109
AMK 1000T	1.000	2.00 mm	36,420	2002108

AMK 100- T

Kanal Tipi Genişlik Modül
Type Width Module

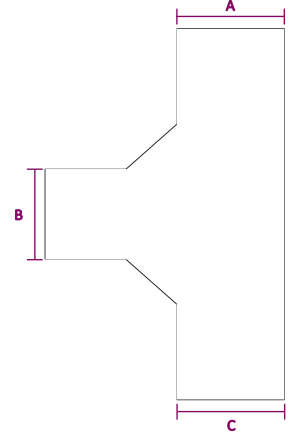

ARTIM METAL ELEKTRİK A.Ş.

W = GENİŞLİK = WIDTH / T = KALINLIK = THICKNESS

- * Farklı kalınlık ve ölçülerde üretim yapılabılır.
- * Malzeme ağırlıkları yaklaşık değerlerdir, ± %10 değişiklik gösterebilir.
- * Malzeme kalınlık toleransı ± %10 dur.
- * Lütfen siparişlerinizde sipariş kodu veya ürün kodu ve Kaplama şeklini belirtiniz.

- * We can produce cable trays different thickness and dimensions
- * Cable trays are shown approximately weight, they could change ± %10 difference.
- * Cable trays thickness tolerances are shown ± %10 .
- * Please indicate order code and coating type in your orders.

AKK SERIES

MERDIVEN DÖRTLÜ BAĞLANTI KAPAKLARI

LADDER FOUR WAY CROSSING COVERS

SICAK DALDIRMA (SD)

HOT DIP GALVANIZED (HDG)

TS EN ISO 1461



4LÜ

Sipariş Kodu Order Code	W (mm)	T (mm)	Ağırlık (kg/ad) Weight (kg/pcs)	Barkod Kodu Barcode Code
AMK 100D	100	1.50 mm	2,182	2002101
AMK 200D	200	1.50 mm	4,168	2002102
AMK 300D	300	1.50 mm	6,415	2002103
AMK 400D	400	2.00 mm	11,895	2002104
AMK 500D	500	2.00 mm	15,583	2002105
AMK 600D	600	2.00 mm	19,617	2002106
AMK 700D	700	2.00 mm	23,148	2002107
AMK 800D	800	2.00 mm	27,314	2002108
AMK 900D	900	2.00 mm	31,957	2002109
AMK 1000D	1.000	2.00 mm	37,389	2002108

AMK 100- D

Kanal Tipi Genişlik Modül
Type Width Module

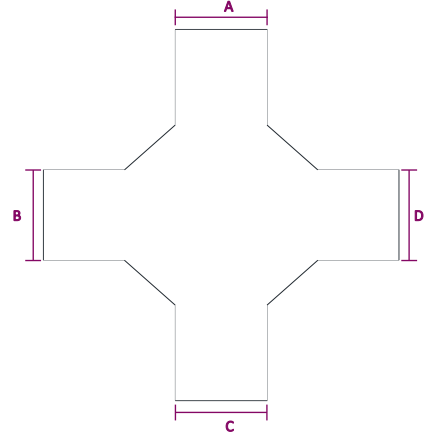

R300

Sipariş Kodu Order Code	W (mm)	T (mm)	Ağırlık (kg/ad) Weight (kg/pcs)	Barkod Kodu Barcode Code
AMK 100D	100	1.50 mm	2,291	2002101
AMK 200D	200	1.50 mm	4,376	2002102
AMK 300D	300	1.50 mm	6,736	2002103
AMK 400D	400	2.00 mm	12,490	2002104
AMK 500D	500	2.00 mm	16,362	2002105
AMK 600D	600	2.00 mm	20,598	2002106
AMK 700D	700	2.00 mm	24,305	2002107
AMK 800D	800	2.00 mm	28,680	2002108
AMK 900D	900	2.00 mm	33,555	2002109
AMK 1000D	1.000	2.00 mm	39,258	2002108

R450

Sipariş Kodu Order Code	W (mm)	T (mm)	Ağırlık (kg/ad) Weight (kg/pcs)	Barkod Kodu Barcode Code
AMK 100D	100	1.50 mm	2,474	2002101
AMK 200D	200	1.50 mm	4,727	2002102
AMK 300D	300	1.50 mm	7,275	2002103
AMK 400D	400	2.00 mm	13,489	2002104
AMK 500D	500	2.00 mm	17,671	2002105
AMK 600D	600	2.00 mm	22,246	2002106
AMK 700D	700	2.00 mm	26,250	2002107
AMK 800D	800	2.00 mm	30,974	2002108
AMK 900D	900	2.00 mm	36,239	2002109
AMK 1000D	1.000	2.00 mm	42,399	2002108

R600

Sipariş Kodu Order Code	W (mm)	T (mm)	Ağırlık (kg/ad) Weight (kg/pcs)	Barkod Kodu Barcode Code
AMK 100D	100	1.50 mm	2,722	2002101
AMK 200D	200	1.50 mm	5,199	2002102
AMK 300D	300	1.50 mm	8,002	2002103
AMK 400D	400	2.00 mm	14,838	2002104
AMK 500D	500	2.00 mm	19,438	2002105
AMK 600D	600	2.00 mm	24,470	2002106
AMK 700D	700	2.00 mm	28,875	2002107
AMK 800D	800	2.00 mm	34,071	2002108
AMK 900D	900	2.00 mm	39,863	2002109
AMK 1000D	1.000	2.00 mm	46,639	2002108

W = GENİŞLİK = WIDTH / T = KALINLIK = THICKNESS

- * Farklı kalınlık ve ölçülerde üretim yapıla bilinir.
- * Malzeme ağırlıkları yaklaşık değerlerdir, ± %10 değişiklik gösterebilir.
- * Malzeme kalınlık toleransı ± %10 dur.
- * Lütfen siparişlerinizde sipariş kodu veya ürün kodu ve kaplama şeklini belirtiniz.

- * We can produce cable trays different thickness and dimensions
- * Cable trays are shown approximately weight, they could chande ± %10 difference.
- * Cable trays thickness tolerances are shown ± %10 .
- * Please indicate order code and coating type in your orders.

AKK SERIES

KAPAK TUTUCU (VİDASIZ)

COVER CLAMP WITHOUT SCREW

PREGALVANİZ (PG)
PREGALVANIZED (PG)
TS EN 10346



Sipariş Kodu Order Code	H (mm)	T (mm)	Ağırlık (kg/ad) Weight (kg/pcs)	Barkod Kodu Barcode Code
AKT-4	40 mm	1.50 mm	0,025	2001545

H40

Sipariş Kodu Order Code	H (mm)	T (mm)	Ağırlık (kg/ad) Weight (kg/pcs)	Barkod Kodu Barcode Code
AKT-5	50 mm	1.50 mm	0,030	2001546

H50

Sipariş Kodu Order Code	H (mm)	T (mm)	Ağırlık (kg/ad) Weight (kg/pcs)	Barkod Kodu Barcode Code
AKT-6	60 mm	1.50 mm	0,032	2001547

H60

Sipariş Kodu Order Code	H (mm)	T (mm)	Ağırlık (kg/ad) Weight (kg/pcs)	Barkod Kodu Barcode Code
AKT-7	70 mm	1.50 mm	0,034	2001548

H75

Sipariş Kodu Order Code	H (mm)	T (mm)	Ağırlık (kg/ad) Weight (kg/pcs)	Barkod Kodu Barcode Code
AKT-10	100 mm	1.50 mm	0,050	2001549

H100

Sipariş Kodu Order Code	H (mm)	T (mm)	Ağırlık (kg/ad) Weight (kg/pcs)	Barkod Kodu Barcode Code
AKT-15	150 mm	1.50 mm	0,081	2001550

H150

H = YÜKSEKLİK = HEIGHT / T = KALINLIK = THICKNESS

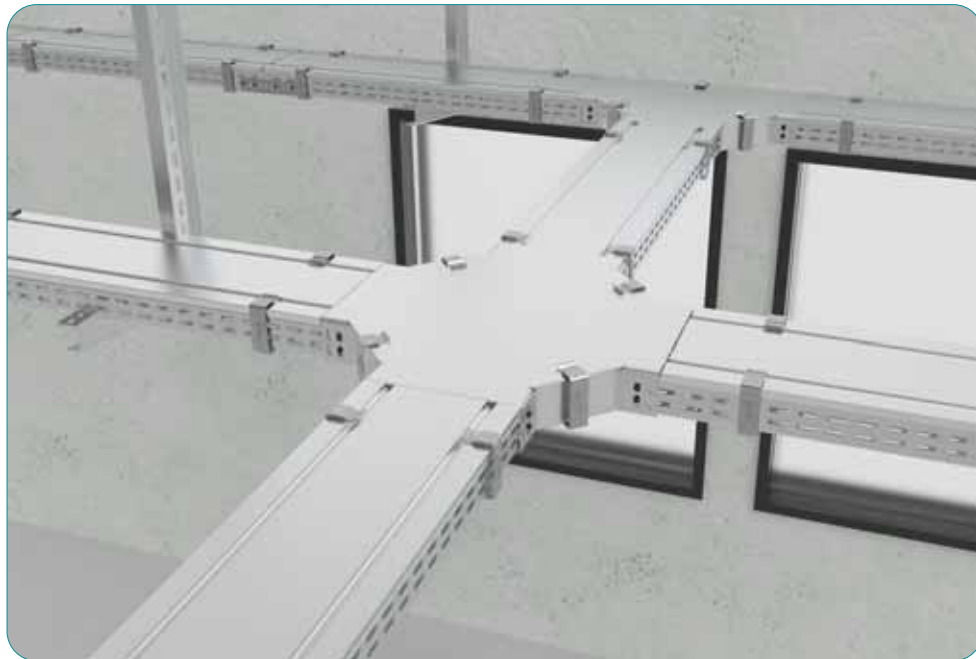
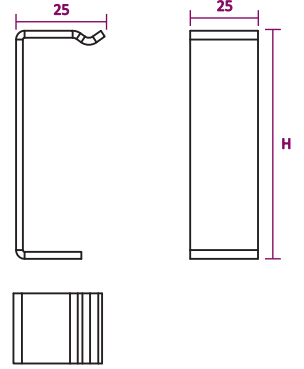

ARTIM METAL ELEKTRİK A.Ş.

- * Farklı kalınlık ve ölçülerde üretim yapılabılır.
- * Malzeme ağırlıkları yaklaşık değerlerdir, \pm %10 değişiklik gösterebilir.
- * Malzeme kalınlık toleransı \pm %10 dur.
- * Lütfen siparişlerinizde sipariş kodu veya ürün kodu ve Kaplama şeklini belirtiniz.

- * We can produce cable trays different thickness and dimensions
- * Cable trays are shown approximately weight, they could change \pm %10 difference.
- * Cable trays thickness tolerances are shown \pm %10 .
- * Please indicate order code and coating type in your orders.