

# art

POWER CARRYING SOLUTIONS



## TEL ÖRGÜ KABLO KANALLARI

WIREMESH CABLE TRAYS

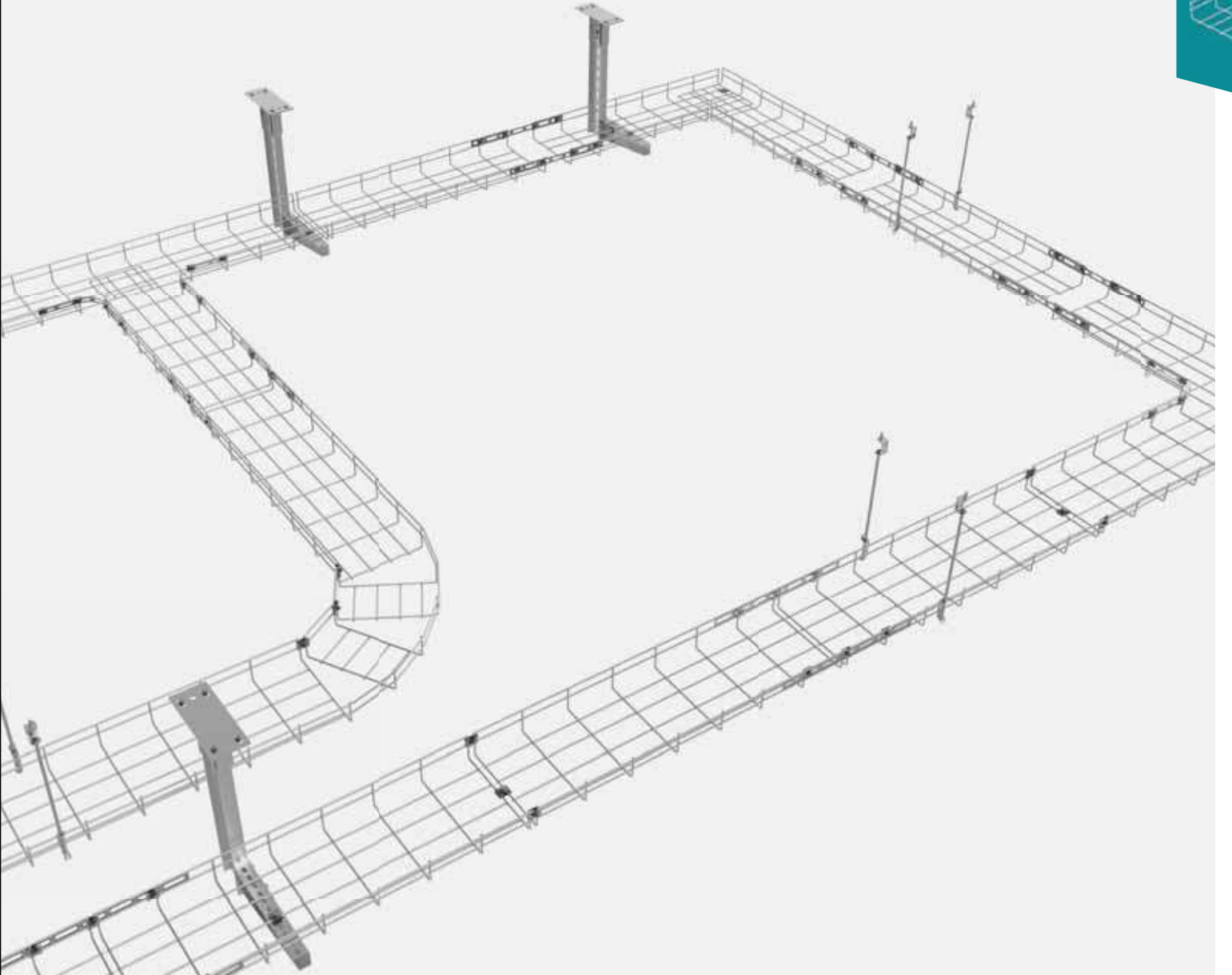

# ART SERIES

## H35 TEL ÖRGÜ KABLO KANALI

### H35 WIREMESH CABLE TRAYS

ELEKTRO GALVANİZ (EG)  
ELECTRO GALVANIZED (EG)  
TS 149

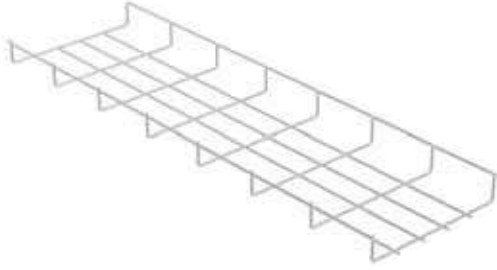

H35 = Tek Sıra Tel  
H35 = Single Row Wire

Q4

Sipariş Kodu Order Code	W (mm)	T (mm)	Ağırlık (kg/m) Weight (kg/m)	Barkod Kodu Barcode Code
35 ART 050	50	Q4	0,497	2004000
35 ART 100	100	Q4	0,523	2004001
35 ART 150	150	Q4	0,665	2004002
35 ART 200	200	Q4	0,808	2004003
35 ART 250	250	Q4	0,951	2004004
35 ART 300	300	Q4	1,093	2004005
35 ART 400	400	Q4	1,378	2004006
35 ART 500	500	Q4	1,664	2004007
35 ART 600	600	Q4	1,949	2004008

35 ART 100- 4

Yükseklik Kanal Tipi Genişlik Kalınlık  
Height Type Width Thickness

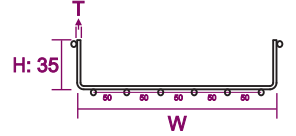

Q5

Sipariş Kodu Order Code	W (mm)	T (mm)	Ağırlık (kg/m) Weight (kg/m)	Barkod Kodu Barcode Code
35 ART 050	50	Q5	0,621	2004009
35 ART 100	100	Q5	0,941	2004010
35 ART 150	150	Q5	1,197	2004011
35 ART 200	200	Q5	1,454	2004012
35 ART 250	250	Q5	1,721	2004013
35 ART 300	300	Q5	1,967	2004014
35 ART 400	400	Q5	2,480	2004015
35 ART 500	500	Q5	2,995	2004016
35 ART 600	600	Q5	3,508	2004017

W 050 = Tek Sıra Tel  
W 100 = İki Sıra Tel  
W 150 = Üç Sıra Tel  
W 200 = Dört Sıra Tel  
W 250 = Bes Sıra Tel  
W 300 = Altı Sıra Tel  
W 400 = Sekiz Sıra Tel  
W 500 = On Sıra Tel  
W 600 = On iki Sıra Tel

W 050 = Single Row Wire  
W 100 = Two Rows of Wire  
W 150 = Three Row Wire  
W 200 = Four Row Wire  
W 250 = Five Row Wires  
W 300 = Six Row Wire  
W 400 = Eight Row Wire  
W 500 = Ten Row Wires  
W 600 = Twelve Row Wires

Standart uzunluk L:3000 mm  
Toplu miktarlarda Özel ölçüler yapılabilir.  
Standard Length L:3000 mm  
Custom sizes can be made in bulk quantities.

H = YÜKSEKLİK = HEIGHT / W = GENİŞLİK = WIDTH / T = KALINLIK = THICKNESS

Q4

Sipariş Kodu Order Code	W (mm)	T (mm)	Ağırlık (kg/m) Weight (kg/m)	Barkod Kodu Barcode Code
35 ART 050	50	Q4	0,542	2004000
35 ART 100	100	Q4	0,570	2004001
35 ART 150	150	Q4	0,725	2004002
35 ART 200	200	Q4	0,881	2004003
35 ART 250	250	Q4	1,037	2004004
35 ART 300	300	Q4	1,191	2004005
35 ART 400	400	Q4	1,502	2004006
35 ART 500	500	Q4	1,814	2004007
35 ART 600	600	Q4	2,124	2004008

Q5

Sipariş Kodu Order Code	W (mm)	T (mm)	Ağırlık (kg/m) Weight (kg/m)	Barkod Kodu Barcode Code
35 ART 050	50	Q5	0,677	2004009
35 ART 100	100	Q5	1,026	2004010
35 ART 150	150	Q5	1,305	2004011
35 ART 200	200	Q5	1,585	2004012
35 ART 250	250	Q5	1,876	2004013
35 ART 300	300	Q5	2,144	2004014
35 ART 400	400	Q5	2,703	2004015
35 ART 500	500	Q5	3,265	2004016
35 ART 600	600	Q5	3,824	2004017

H = YÜKSEKLİK = HEIGHT / W = GENİŞLİK = WIDTH / T = KALINLIK = THICKNESS

SICAK DALDIRMA (SD)  
HOT DIP GALVANIZED (SD)  
TS EN ISO 1461

ARTIM METAL ELEKTRİK A.Ş.

\* Farklı kalınlık ve ölçülerde üretim yapılabılır.  
\* Malzeme ağırlıkları yaklaşık değerlerdir, ± %10 değişiklik gösterebilir.  
\* Malzeme kalınlık toleransı ± %10 dur.  
\* Lütfen siparişlerinizde sipariş kodu veya ürün kodu ve Kaplama şeklini belirtiniz.

\* We can produce cable trays different thickness and dimensions  
\* Cable trays are shown approximately weight, they could change ± %10 difference.  
\* Cable trays thickness tolerances are shown ± %10 .  
\* Please indicate order code and coating type in your orders.

# ART SERIES

## H50 TEL ÖRGÜ KABLO KANALI

### H50 WIREMESH CABLE TRAYS

ELEKTRO GALVANİZ (EG)  
ELECTRO GALVANIZED (EG)  
TS 149

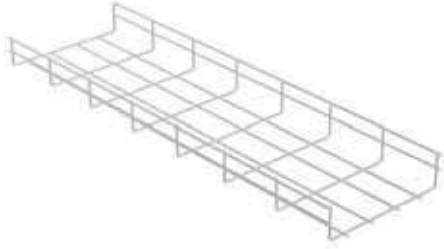

H50 = İki Sıra Tel  
H50 = Two Rows of Wire

SICAK DALDIRMA (SD)  
HOT DIP GALVANIZED (SD)  
TS EN ISO 1461

Q4

Sipariş Kodu Order Code	W (mm)	T (mm)	Ağırlık (kg/m) Weight (kg/m)	Barkod Kodu Barcode Code
50 ART 050	50	Q4	0,650	2004020
50 ART 100	100	Q4	0,800	2004021
50 ART 150	150	Q4	0,950	2004022
50 ART 200	200	Q4	1,105	2004023
50 ART 250	250	Q4	1,249	2004024
50 ART 300	300	Q4	1,402	2004025
50 ART 400	400	Q4	1,713	2004026
50 ART 500	500	Q4	2,012	2004027
50 ART 600	600	Q4	2,324	2004028

Q5

Sipariş Kodu Order Code	W (mm)	T (mm)	Ağırlık (kg/m) Weight (kg/m)	Barkod Kodu Barcode Code
50 ART 050	50	Q5	0,812	2004029
50 ART 100	100	Q5	1,110	2004030
50 ART 150	150	Q5	1,330	2004031
50 ART 200	200	Q5	1,560	2004032
50 ART 250	250	Q5	1,780	2004033
50 ART 300	300	Q5	1,998	2004034
50 ART 400	400	Q5	2,432	2004035
50 ART 500	500	Q5	2,862	2004036
50 ART 600	600	Q5	3,292	2004037

H = YÜKSEKLİK = HEIGHT / W = GENİŞLİK = WIDTH / T = KALINLIK = THICKNESS

50 ART 100- 4

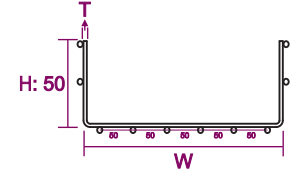

W 050 = Tek Sıra Tel  
W 100 = İki Sıra Tel  
W 150 = Üç Sıra Tel  
W 200 = Dört Sıra Tel  
W 250 = Bes Sıra Tel  
W 300 = Altı Sıra Tel  
W 400 = Sekiz Sıra Tel  
W 500 = On Sıra Tel  
W 600 = On iki Sıra Tel

W 050 = Single Row Wire  
W 100 = Two Rows of Wire  
W 150 = Three Row Wire  
W 200 = Four Row Wire  
W 250 = Five Row Wires  
W 300 = Six Row Wire  
W 400 = Eight Row Wire  
W 500 = Ten Row Wires  
W 600 = Twelve Row Wires

Standart uzunluk L:3000 mm  
Toplu miktarlarda Özel ölçüler yapılabilir.  
Standard Length L:3000 mm  
Custom sizes can be made in bulk quantities.

Q4

Sipariş Kodu Order Code	W (mm)	T (mm)	Ağırlık (kg/m) Weight (kg/m)	Barkod Kodu Barcode Code
50 ART 050	50	Q4	0,709	2004020
50 ART 100	100	Q4	0,872	2004021
50 ART 150	150	Q4	1,036	2004022
50 ART 200	200	Q4	1,204	2004023
50 ART 250	250	Q4	1,361	2004024
50 ART 300	300	Q4	1,528	2004025
50 ART 400	400	Q4	1,867	2004026
50 ART 500	500	Q4	2,193	2004027
50 ART 600	600	Q4	2,533	2004028

Q5

Sipariş Kodu Order Code	W (mm)	T (mm)	Ağırlık (kg/m) Weight (kg/m)	Barkod Kodu Barcode Code
50 ART 050	50	Q5	0,885	2004029
50 ART 100	100	Q5	1,210	2004030
50 ART 150	150	Q5	1,450	2004031
50 ART 200	200	Q5	1,700	2004032
50 ART 250	250	Q5	1,940	2004033
50 ART 300	300	Q5	2,178	2004034
50 ART 400	400	Q5	2,651	2004035
50 ART 500	500	Q5	3,120	2004036
50 ART 600	600	Q5	3,588	2004037

H = YÜKSEKLİK = HEIGHT / W = GENİŞLİK = WIDTH / T = KALINLIK = THICKNESS

\* Farklı kalınlık ve ölçülerde üretim yapılabılır.  
\* Malzeme ağırlıkları yaklaşık değerlerdir, ± %10 değişiklik gösterebilir.  
\* Malzeme kalınlık toleransı ± %10 dur.  
\* Lütfen siparişlerinizde sipariş kodu veya ürün kodu ve Kaplama şeklini belirtiniz.

\* We can produce cable trays different thickness and dimensions  
\* Cable trays are shown approximately weight, they could change ± %10 difference.  
\* Cable trays thickness tolerances are shown ± %10 .  
\* Please indicate order code and coating type in your orders.

# ART SERIES

## H85 TEL ÖRGÜ KABLO KANALI

### H85 WIREMESH CABLE TRAYS

ELEKTRO GALVANİZ (EG)  
ELECTRO GALVANIZED (EG)  
TS 149

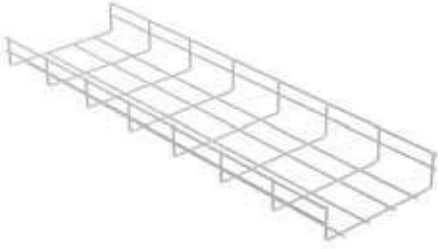

H85 = İki Sıra Tel  
H85 = Two Rows of Wire

Q4

Sipariş Kodu Order Code	W (mm)	T (mm)	Ağırlık (kg/m) Weight (kg/m)	Barkod Kodu Barcode Code
85 ART 100	100	Q4	0,808	2004041
85 ART 150	150	Q4	0,951	2004042
85 ART 200	200	Q4	1,093	2004043
85 ART 250	250	Q4	1,236	2004044
85 ART 300	300	Q4	1,378	2004045
85 ART 400	400	Q4	1,664	2004046
85 ART 500	500	Q4	1,949	2004047
85 ART 600	600	Q4	2,238	2004048

Q5

Sipariş Kodu Order Code	W (mm)	T (mm)	Ağırlık (kg/m) Weight (kg/m)	Barkod Kodu Barcode Code
85 ART 100	100	Q5	1,483	2004049
85 ART 150	150	Q5	1,746	2004050
85 ART 200	200	Q5	2,007	2004051
85 ART 250	250	Q5	2,117	2004052
85 ART 300	300	Q5	2,269	2004053
85 ART 400	400	Q5	2,554	2004054
85 ART 500	500	Q5	2,991	2004055
85 ART 600	600	Q5	3,428	2004056

H = YÜKSEKLİK = HEIGHT / W = GENİŞLİK = WIDTH / T = KALINLIK = THICKNESS

85 ART 100- 4

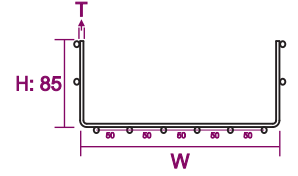

W 100 = İki Sıra Tel  
W 150 = Üç Sıra Tel  
W 200 = Dört Sıra Tel  
W 250 = Bes Sıra Tel  
W 300 = Altı Sıra Tel  
W 400 = Sekiz Sıra Tel  
W 500 = On Sıra Tel  
W 600 = On iki Sıra Tel

W 100 = Two Rows of Wire  
W 150 = Three Row Wire  
W 200 = Four Row Wire  
W 250 = Five Row Wires  
W 300 = Six Row Wire  
W 400 = Eight Row Wire  
W 500 = Ten Row Wires  
W 600 = Twelve Row Wires

Standart uzunluk L:3000 mm  
Toplu miktarlarda Özel ölçüler yapılabilir.  
Standard Length L:3000 mm  
Custom sizes can be made in bulk quantities.

SICAK DALDIRMA (SD)  
HOT DIP GALVANIZED (SD)  
TS EN ISO 1461

Q4

Sipariş Kodu Order Code	W (mm)	T (mm)	Ağırlık (kg/m) Weight (kg/m)	Barkod Kodu Barcode Code
85 ART 100	100	Q4	0,881	2004041
85 ART 150	150	Q4	1,037	2004042
85 ART 200	200	Q4	1,191	2004043
85 ART 250	250	Q4	1,347	2004044
85 ART 300	300	Q4	1,502	2004045
85 ART 400	400	Q4	1,814	2004046
85 ART 500	500	Q4	2,124	2004047
85 ART 600	600	Q4	2,439	2004048

Q5

Sipariş Kodu Order Code	W (mm)	T (mm)	Ağırlık (kg/m) Weight (kg/m)	Barkod Kodu Barcode Code
85 ART 100	100	Q5	1,616	2004049
85 ART 150	150	Q5	1,903	2004050
85 ART 200	200	Q5	2,188	2004051
85 ART 250	250	Q5	2,308	2004052
85 ART 300	300	Q5	2,473	2004053
85 ART 400	400	Q5	2,784	2004054
85 ART 500	500	Q5	3,260	2004055
85 ART 600	600	Q5	3,737	2004056

H = YÜKSEKLİK = HEIGHT / W = GENİŞLİK = WIDTH / T = KALINLIK = THICKNESS

ARTIM METAL ELEKTRİK A.Ş.

\* Farklı kalınlık ve ölçülerde üretim yapılabılır.  
\* Malzeme ağırlıkları yaklaşık değerlerdir, ± %10 değişiklik gösterebilir.  
\* Malzeme kalınlık toleransı ± %10 dur.  
\* Lütfen siparişlerinizde sipariş kodu veya ürün kodu ve Kaplama şeklini belirtiniz.

\* We can produce cable trays different thickness and dimensions  
\* Cable trays are shown approximately weight, they could change ± %10 difference.  
\* Cable trays thickness tolerances are shown ± %10 .  
\* Please indicate order code and coating type in your orders.

# ART SERIES

## H100 TEL ÖRGÜ KABLO KANALI

### H100 WIREMESH CABLE TRAYS

#### ELEKTRO GALVANİZ (EG)

#### ELECTRO GALVANIZED (EG)

TS 149



H100 = Üç Sıra Tel  
H100 = Three Row Wire

#### Q4

Sipariş Kodu Order Code	W (mm)	T (mm)	Ağırlık (kg/m) Weight (kg/m)	Barkod Kodu Barcode Code
100 ART 100	100	Q4	1,050	2004060
100 ART 150	150	Q4	1,118	2004061
100 ART 200	200	Q4	1,331	2004062
100 ART 250	250	Q4	1,474	2004063
100 ART 300	300	Q4	1,616	2004064
100 ART 400	400	Q4	1,901	2004065
100 ART 500	500	Q4	2,187	2004066
100 ART 600	600	Q4	2,482	2004067

#### Q5

Sipariş Kodu Order Code	W (mm)	T (mm)	Ağırlık (kg/m) Weight (kg/m)	Barkod Kodu Barcode Code
100 ART 100	100	Q5	1,890	2004068
100 ART 150	150	Q5	2,012	2004069
100 ART 200	200	Q5	2,396	2004070
100 ART 250	250	Q5	2,485	2004071
100 ART 300	300	Q5	2,652	2004072
100 ART 400	400	Q5	2,922	2004073
100 ART 500	500	Q5	3,359	2004074
100 ART 600	600	Q5	3,796	2004075

H = YÜKSEKLİK = HEIGHT / W = GENİŞLİK = WIDTH / T = KALINLIK = THICKNESS

#### 100 ART 100- 4

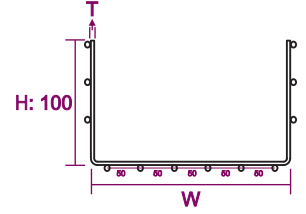

W 100 = İki Sıra Tel  
W 150 = Üç Sıra Tel  
W 200 = Dört Sıra Tel  
W 250 = Bes Sıra Tel  
W 300 = Altı Sıra Tel  
W 400 = Sekiz Sıra Tel  
W 500 = On Sıra Tel  
W 600 = On iki Sıra Tel

W 100 = Two Rows of Wire  
W 150 = Three Row Wire  
W 200 = Four Row Wire  
W 250 = Five Row Wires  
W 300 = Six Row Wire  
W 400 = Eight Row Wire  
W 500 = Ten Row Wires  
W 600 = Twelve Row Wires

Standart uzunluk L:3000 mm  
Toplu miktarlarda Özel ölçüler yapılabilir.  
Standard Length L:3000 mm  
Custom sizes can be made in bulk quantities.

#### SICAK DALDIRMA (SD)

#### HOT DIP GALVANIZED (SD)

TS EN ISO 1461

#### Q4

Sipariş Kodu Order Code	W (mm)	T (mm)	Ağırlık (kg/m) Weight (kg/m)	Barkod Kodu Barcode Code
100 ART 100	100	Q4	1,145	2004060
100 ART 150	150	Q4	1,219	2004061
100 ART 200	200	Q4	1,451	2004062
100 ART 250	250	Q4	1,607	2004063
100 ART 300	300	Q4	1,761	2004064
100 ART 400	400	Q4	2,072	2004065
100 ART 500	500	Q4	2,384	2004066
100 ART 600	600	Q4	2,705	2004067

#### Q5

Sipariş Kodu Order Code	W (mm)	T (mm)	Ağırlık (kg/m) Weight (kg/m)	Barkod Kodu Barcode Code
100 ART 100	100	Q5	2,060	2004068
100 ART 150	150	Q5	2,193	2004069
100 ART 200	200	Q5	2,612	2004070
100 ART 250	250	Q5	2,891	2004071
100 ART 300	300	Q5	2,709	2004072
100 ART 400	400	Q5	3,185	2004073
100 ART 500	500	Q5	3,661	2004074
100 ART 600	600	Q5	4,138	2004075

H = YÜKSEKLİK = HEIGHT / W = GENİŞLİK = WIDTH / T = KALINLIK = THICKNESS

\* Farklı kalınlık ve ölçülerde üretim yapılabılır.  
\* Malzeme ağırlıkları yaklaşık değerlerdir, ± %10 değişiklik gösterebilir.  
\* Malzeme kalınlık toleransı ± %10 dur.  
\* Lütfen siparişlerinizde sipariş kodu veya ürün kodu ve Kaplama şeklini belirtiniz.

\* We can produce cable trays different thickness and dimensions  
\* Cable trays are shown approximately weight, they could change ± %10 difference.  
\* Cable trays thickness tolerances are shown ± %10 .  
\* Please indicate order code and coating type in your orders.

# ART SERIES

## TEL ÖRGÜ KANAL BAĞLANTILARI

### WIRE MESH CABLE TRAY CONNECTIONS

PREGALVANİZ (PG)  
PREGALVANIZED (PG)  
TS EN 10346



#### BİRLEŞTİRME ELEMANI / CONNECTOR

Sipariş Kodu Order Code	Ebat (mm) Size (mm)	T (mm)	Ağırlık (kg/ad) Weight (kg/pcs)	Barkod Kodu Barcode Code
ART-6-1B	30	2.50 mm	0,012	2004101
ART-6-1K	25	2.50 mm	0,010	2004102

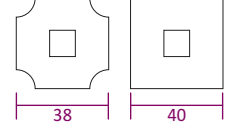

Her bir ürüne 1 adet M6x15 Civata ve 1 adet M6 Somun kullanılmaktadır. Ayrı satılmaktadır.  
1 M6x15 Bolt and 1 M6 Nut are used for each product. It is sold separately.

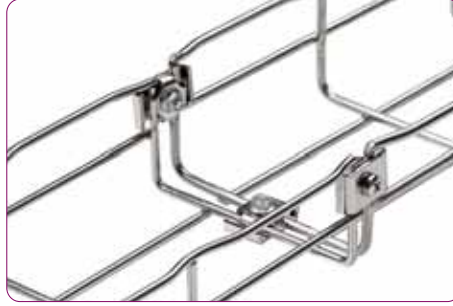

#### Kanal ebatlarına göre önerilen bağlantı adetleri / Recommended connection sizes according to channel sizes

W (mm)	H35/H50	H85/H100
50	2	-
100	2	2+1
150	2	2+1
200	2+1	2+2
250	2+1	2+2
300	2+2	2+3
400	2+2	2+3
500	2+2	2+3
600	2+2	2+3

H = YÜKSEKLİK = HEIGHT / W = GENİŞLİK = WIDTH

PREGALVANİZ (PG)  
PREGALVANIZED (PG)  
TS EN 10346



#### BİRLEŞTİRME ELEMANI / CONNECTOR

Sipariş Kodu Order Code	Ebat (mm) Size (mm)	T (mm)	Ağırlık (kg/ad) Weight (kg/pcs)	Barkod Kodu Barcode Code
ART-6-1K	25	2.50 mm	0,010	2004102

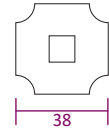

Her bir ürüne 1 adet M6x15 Civata ve 1 adet M6 Somun kullanılmaktadır. Ayrı satılmaktadır.  
1 M6x15 Bolt and 1 M6 Nut are used for each product. It is sold separately.

#### Kanal ebatlarına göre önerilen sabitleme adetleri / Fixing pieces recommended according to tray sizes

W (mm)	ad/pcs
50	1
100	1
150	1
200	2
250	2
300	2
400	2
500	2
600	2

W = GENİŞLİK = WIDTH

ARTIM METAL ELEKTRİK A.Ş.

- \* Farklı kalınlık ve ölçülerde üretim yapılabılır.
- \* Malzeme ağırlıkları yaklaşık değerlerdir,  $\pm$  %10 değişiklik gösterebilir.
- \* Malzeme kalınlık toleransı  $\pm$  %10 dur.
- \* Lütfen siparişlerinizde sipariş kodu veya ürün kodu ve Kaplama şeklini belirtiniz.

- \* We can produce cable trays different thickness and dimensions
- \* Cable trays are shown approximately weight, they could change  $\pm$  %10 difference.
- \* Cable trays thickness tolerances are shown  $\pm$  %10 .
- \* Please indicate order code and coating type in your orders.

# ART SERIES

## TEL ÖRGÜ KANAL BAĞLANTILARI

### WIRE MESH CABLE TRAY CONNECTIONS

PREGALVANIZ (PG)  
PREGALVANIZED (PG)  
TS EN 10346

#### HIZLI BİRLEŞTİRME / BOLTLESS QUICK

Sipariş Kodu Order Code	Ebat (mm) Size (mm)	T (mm)	Ağırlık (kg/ad) Weight (kg/pcs)	Barkod Kodu Barcode Code
ART-8	220X18	1.20 mm	0,090	2004100

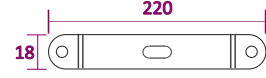

H50 / H85 / H100 Kanallari birleştirme için kullanilir.  
H50 / H85 / H100 Used for joining trays.

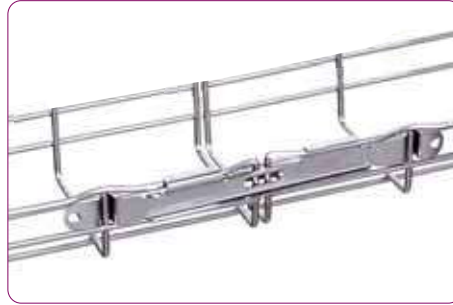

PREGALVANIZ (PG)  
PREGALVANIZED (PG)  
TS EN 10346

#### BİRLEŞTİRME ELEMANI / CONNECTOR

Sipariş Kodu Order Code	Ebat (mm) Size (mm)	T (mm)	Ağırlık (kg/ad) Weight (kg/pcs)	Barkod Kodu Barcode Code
ART-5-1	300	2.00 mm	0,012	2004121
ART-5-2	350	2.00 mm	0,010	2004122
ART-5-3	400	2.00 mm	0,012	2004123
ART-5-4	450	2.00 mm	0,010	2004124
ART-5-5	500	2.00 mm	0,012	2004125
ART-5-6	550	2.00 mm	0,010	2004126
ART-5-7	600	2.00 mm	0,012	2004127



Düz birleştirme, Redüksiyon birleştirme  
Dereceli birleştirme olarak kullanilir.  
It is used as straight connector, reduction  
connector, graded connector.

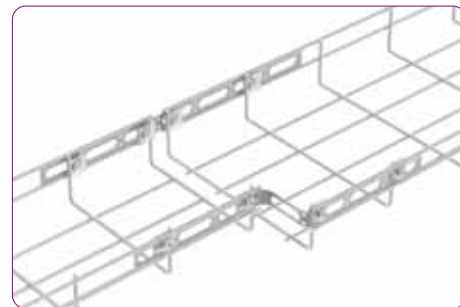
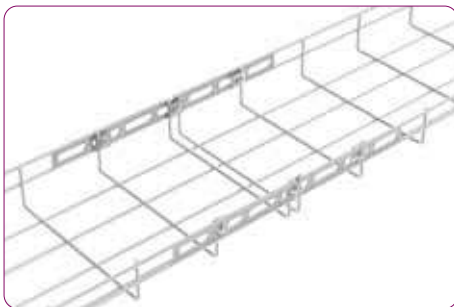

\* Farklı kalınlık ve ölçülerde üretim yapılabılır.  
\* Malzeme ağırlıkları yaklaşık değerlerdir,  $\pm$  %10 değişiklik gösterebilir.  
\* Malzeme kalınlık toleransı  $\pm$  %10 dur.  
\* Lütfen siparişlerinizde sipariş kodu veya ürün kodu ve Kaplama şeklini belirtiniz.

\* We can produce cable trays different thickness and dimensions  
\* Cable trays are shown approximately weight, they could change  $\pm$  %10 difference.  
\* Cable trays thickness tolerances are shown  $\pm$  %10 .  
\* Please indicate order code and coating type in your orders.



# ART SERIES

## TEL ÖRGÜ KANAL BAĞLANTILARI

### WIRE MESH CABLE TRAY CONNECTIONS

PREGALVANİZ (PG)  
PREGALVANIZED (PG)  
TS EN 10346

#### TİJLİ KANAL TAŞIYICI / TRAY CARRIERS WHICH USED THREADED ROD

Sipariş Kodu Order Code	Ebat (mm) Size (mm)	T (mm)	Ağırlık (kg/ad) Weight (kg/pcs)	Barkod Kodu Barcode Code
ART-11	60x35	2.00 mm	0,030	2004103

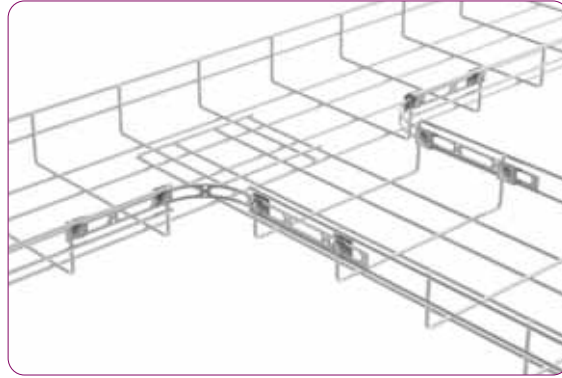
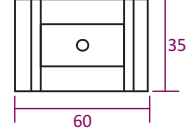

#### TİJLİ KANAL TAŞIYICI / TRAY CARRIERS WHICH USED THREADED ROD

Sipariş Kodu Order Code	Ebat (mm) Size (mm)	T (mm)	Ağırlık (kg/ad) Weight (kg/pcs)	Barkod Kodu Barcode Code
ART-16	110x45	2.00 mm	0,080	2004105

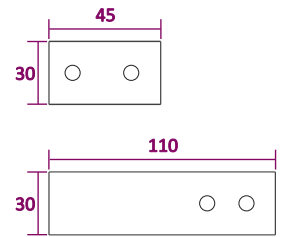

PREGALVANİZ (PG)  
PREGALVANIZED (PG)  
TS EN 10346

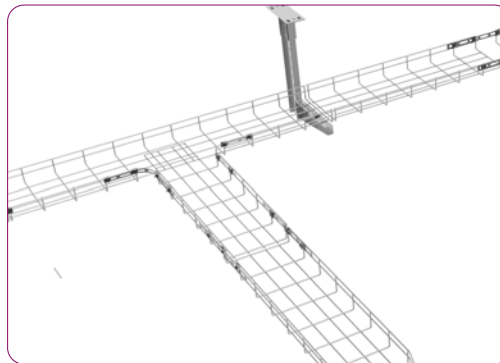

ARTIM METAL ELEKTRİK A.Ş.

- \* Farklı kalınlık ve ölçülerde üretim yapılabılır.
- \* Malzeme ağırlıkları yaklaşık değerlerdir,  $\pm$  %10 değişiklik gösterebilir.
- \* Malzeme kalınlık toleransı  $\pm$  %10 dur.
- \* Lütfen siparişlerinizde sipariş kodu veya ürün kodu ve Kaplama şeklini belirtiniz.

- \* We can produce cable trays different thickness and dimensions
- \* Cable trays are shown approximately weight, they could change  $\pm$  %10 difference.
- \* Cable trays thickness tolerances are shown  $\pm$  %10 .
- \* Please indicate order code and coating type in your orders.



# ART SERIES

## TEL ÖRGÜ KANAL BAĞLANTILARI

### WIRE MESH CABLE TRAY CONNECTIONS

PREGALVANİZ (PG)  
PREGALVANIZED (PG)  
TS EN 10346

#### TIRNAKLI DUVAR TESPİT ELEMANI / FIXING ELEMENT FOR WALL MOUNTING

Sipariş Kodu Order Code	Ebat (mm) Size (mm)	T (mm)	Ağırlık (kg/ad) Weight (kg/pcs)	Barkod Kodu Barcode Code
ART-13	113x30	1.50 mm	0,050	2004104

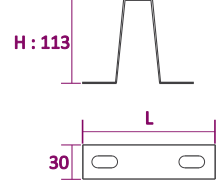

#### DUVAR KONSOLU / BRACKETS FOR MOUNTING

Sipariş Kodu Order Code	Ebat (mm) Size (mm)	T (mm)	Ağırlık (kg/ad) Weight (kg/pcs)	Barkod Kodu Barcode Code
ARTT 050	130	1.50 mm	0,164	2004131
ARTT 100	130	1.50 mm	0,240	2004132
ARTT 150	180	1.50 mm	0,260	2004133
ARTT 200	230	1.50 mm	0,330	2004134

PREGALVANİZ (PG)  
PREGALVANIZED (PG)  
TS EN 10346

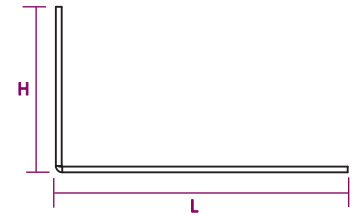

\* Farklı kalınlık ve ölçülerde üretim yapılabılır.  
\* Malzeme ağırlıkları yaklaşık değerlerdir,  $\pm$  %10 değişiklik gösterebilir.  
\* Malzeme kalınlık toleransı  $\pm$  %10 dur.  
\* Lütfen siparişlerinizde sipariş kodu veya ürün kodu ve kaplama şeklini belirtiniz.

\* We can produce cable trays different thickness and dimensions  
\* Cable trays are shown approximately weight, they could change  $\pm$  %10 difference.  
\* Cable trays thickness tolerances are shown  $\pm$  %10 .  
\* Please indicate order code and coating type in your orders.

# ART SERIES

## TEL ÖRGÜ KANAL BAĞLANTILARI

### WIRE MESH CABLE TRAY CONNECTIONS

PREGALVANİZ (PG)  
PREGALVANIZED (PG)  
TS EN 10346

#### KABLO İNİŞ ELEMANI / CABLE GUIDER

Sipariş Kodu Order Code	Ebat (mm) Size (mm)	T (mm)	Ağırlık (kg/ad) Weight (kg/pcs)	Barkod Kodu Barcode Code
ART-7	80x170	2.00 mm	0,150	2004107

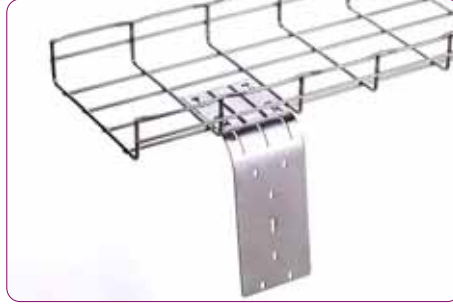
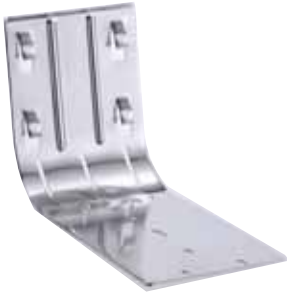
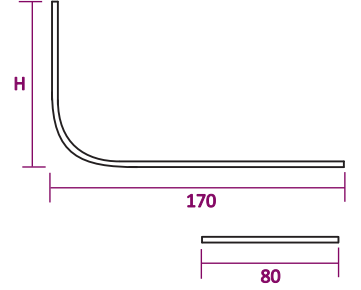

PREGALVANİZ (PG)  
PREGALVANIZED (PG)  
TS EN 10346

#### KANAL TAŞIYICI / TRAY CARRIERS

Sipariş Kodu Order Code	Ebat (mm) Size (mm)	T (mm)	Ağırlık (kg/ad) Weight (kg/pcs)	Barkod Kodu Barcode Code
ART-9	25x52	4.00 mm	0,079	2004108

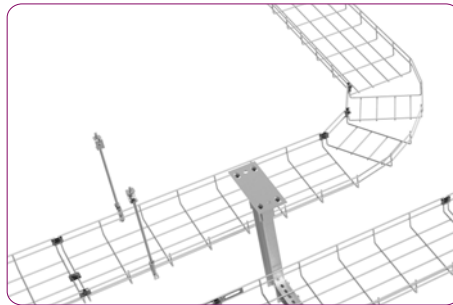
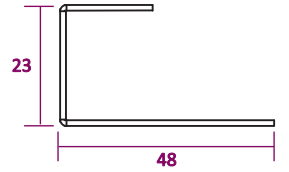

ARTIM METAL ELEKTRİK A.Ş.

- \* Farklı kalınlık ve ölçülerde üretim yapılabılır.
- \* Malzeme ağırlıkları yaklaşık değerlerdir,  $\pm$  %10 değişiklik gösterebilir.
- \* Malzeme kalınlık toleransı  $\pm$  %10 dur.
- \* Lütfen siparişlerinizde sipariş kodu veya ürün kodu ve Kaplama şeklini belirtiniz.

- \* We can produce cable trays different thickness and dimensions
- \* Cable trays are shown approximately weight, they could change  $\pm$  %10 difference.
- \* Cable trays thickness tolerances are shown  $\pm$  %10 .
- \* Please indicate order code and coating type in your orders.

# ART SERIES

## TEL ÖRGÜ KANAL BAĞLANTILARI

### WIRE MESH CABLE TRAY CONNECTIONS

PIRİNÇ  
BRASS  
TS 564

#### TOPRAKLAMA ELEMANI / EARTHING PART

Sipariş Kodu Order Code	Ebat (mm) Size (mm)	Ağırlık (kg/ad) Weight (kg/pcs)	Barkod Kodu Barcode Code
TP-1	M6	0,030	2004141

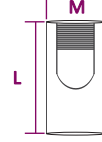
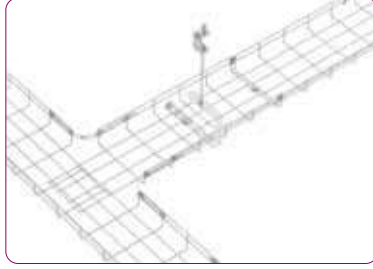

#### TOPRAKLAMA ELEMANI / EARTHING PART

Sipariş Kodu Order Code	Ebat (mm) Size (mm)	Ağırlık (kg/ad) Weight (kg/pcs)	Barkod Kodu Barcode Code
TP-2	16x16	0,032	2004142

PIRİNÇ  
BRASS  
TS 564

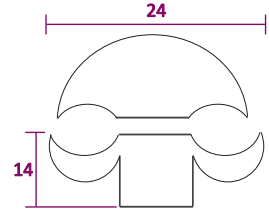

#### ÖRGÜLÜ BAKIR BARA / COPPER CONNECTORS

Sipariş Kodu Order Code	Ebat (mm) Size (mm)	Ağırlık (kg/ad) Weight (kg/pcs)	Barkod Kodu Barcode Code
TP-3	12x82	0,008	2004143

BAKIR  
COPPER



\* Farklı kalınlık ve ölçülerde üretim yapılabılır.  
\* Malzeme ağırlıkları yaklaşık değerlerdir,  $\pm$  %10 değişiklik gösterebilir.  
\* Malzeme kalınlık toleransı  $\pm$  %10 dur.  
\* Lütfen siparişlerinizde sipariş kodu veya ürün kodu ve kaplama şeklini belirtiniz.

\* We can produce cable trays different thickness and dimensions  
\* Cable trays are shown approximately weight, they could change  $\pm$  %10 difference.  
\* Cable trays thickness tolerances are shown  $\pm$  %10 .  
\* Please indicate order code and coating type in your orders.

# ART SERIES

## TEL ÖRGÜ KANAL BAĞLANTILARI

### WIRE MESH CABLE TRAY CONNECTIONS

TEL KANAL NASIL KESİLİR ?

HOW TO CUT WIRE MESH CABLE TRAY?

1.ALT TELLERİ KES / SUB WIRES CUT

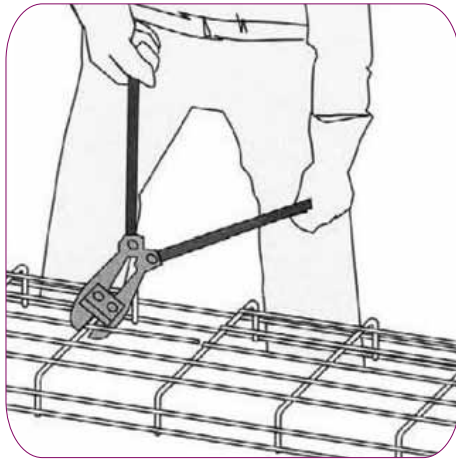

2.KESME SIRALAMASI / CUTTING ORDER

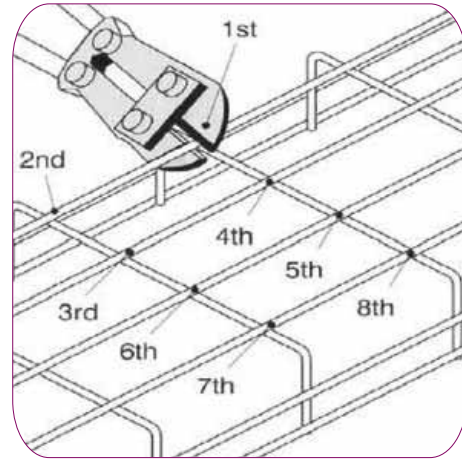

3.YAN KENAR ÜST TELLERİ KES / SIDE EDGE UPPER WIRES CUT

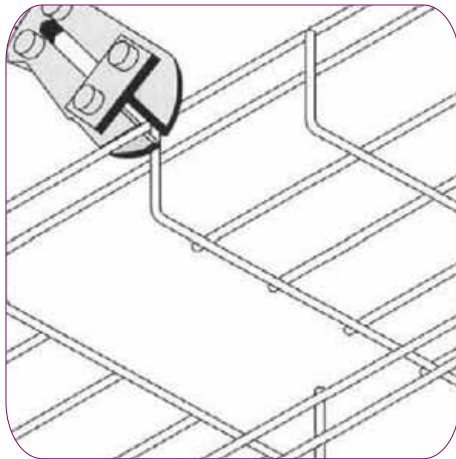

4.YAN KENAR ALT TELLERİ KES / SIDE EDGE LOWER WIRES CUT

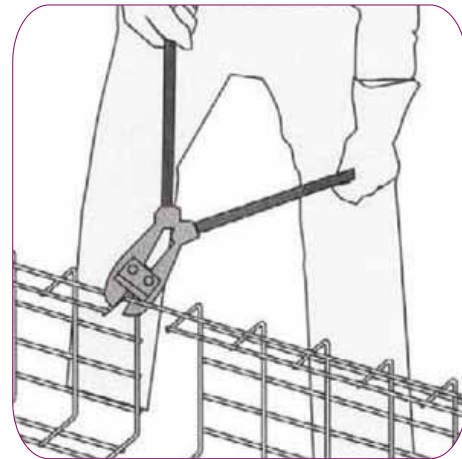

ARTIM METAL ELEKTRİK A.Ş.

- \* Farklı kalınlık ve ölçülerde üretim yapılabılır.
- \* Malzeme ağırlıkları yaklaşık değerlerdir,  $\pm$  %10 değişiklik gösterebilir.
- \* Malzeme kalınlık toleransı  $\pm$  %10 dur.
- \* Lütfen siparişlerinizde sipariş kodu veya ürün kodu ve Kaplama şeklini belirtiniz.

- \* We can produce cable trays different thickness and dimensions
- \* Cable trays are shown approximately weight, they could change  $\pm$  %10 difference.
- \* Cable trays thickness tolerances are shown  $\pm$  %10 .
- \* Please indicate order code and coating type in your orders.

# ART SERIES

## TEL ÖRGÜ KANAL BAĞLANTILARI

### WIRE MESH CABLE TRAY CONNECTIONS

90° Uygulama Örneği  
Practice Example of 90°

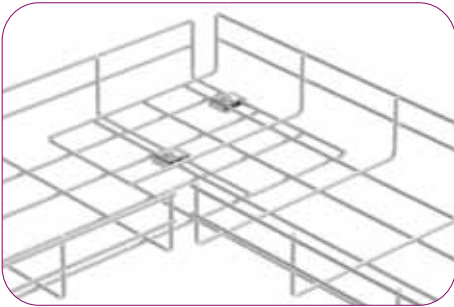
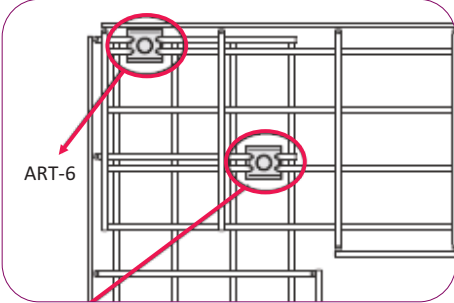
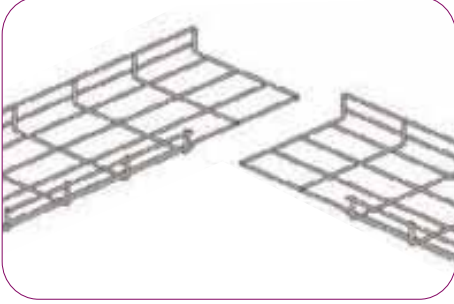
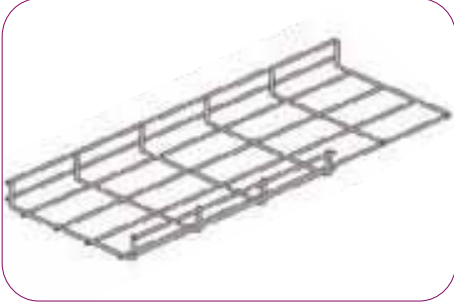

T Uygulama Örneği  
Practice Example of T

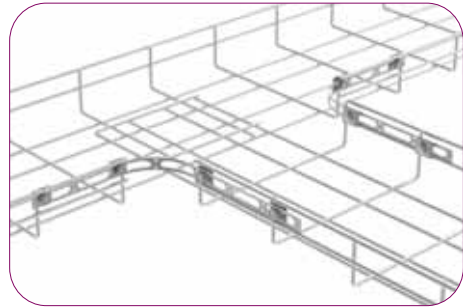
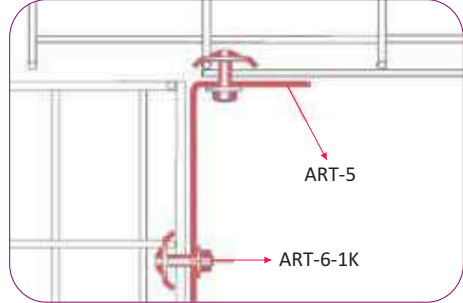
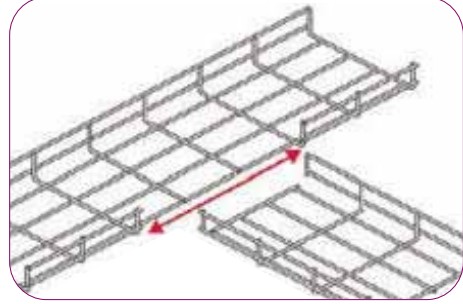
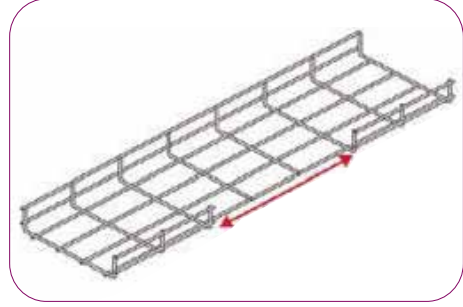

- \* Farklı kalınlık ve ölçülerde üretim yapılabılır.
- \* Malzeme ağırlıkları yaklaşık değerlerdir,  $\pm$  %10 değişiklik gösterebilir.
- \* Malzeme kalınlık toleransı  $\pm$  %10 dur.
- \* Lütfen siparişlerinizde sipariş kodu veya ürün kodu ve kaplama şeklini belirtiniz.

- \* We can produce cable trays different thickness and dimensions
- \* Cable trays are shown approximately weight, they could change  $\pm$  %10 difference.
- \* Cable trays thickness tolerances are shown  $\pm$  %10 .
- \* Please indicate order code and coating type in your orders.

# ART SERIES

## TEL ÖRGÜ KABLO KANAL KAPAKLARI

### WIRE MESH CABLE TRAY COVERS

PREGALVANİZ (PG)  
PREGALVANIZED (PG)  
TS EN 10346



SICAK DALDIRMA (SD)  
HOT DIP GALVANIZED (SD)  
TS EN ISO 1461

PG

Sipariş Kodu Order Code	W (mm)	T (mm)	Ağırlık (kg/m) Weight (kg/m)	Barkod Kodu Barcode Code
ATKK 050-10	50	1.00 mm	0,707	2004150
ATKK 100-10	100	1.00 mm	1,047	2004151
ATKK 150-10	150	1.00 mm	1,147	2004152
ATKK 200-10	200	1.00 mm	1,847	2004153
ATKK 250-10	250	1.00 mm	2,233	2004154
ATKK 300-12	300	1.20 mm	3,147	2004155
ATKK 400-12	400	1.20 mm	4,085	2004156
ATKK 500-15	500	1.50 mm	6,261	2004157
ATKK 600-15	600	1.50 mm	7,483	2004158

ATKK 100 - 10



Standart uzunluk L:3000 mm  
Toplu miktarlarda Özel ölçüler yapılabilir.  
Standard Length L:3000 mm  
Custom sizes can be made in bulk quantities.

SD

Sipariş Kodu Order Code	W (mm)	T (mm)	Ağırlık (kg/m) Weight (kg/m)	Barkod Kodu Barcode Code
ATKK 050-10	50	1.00 mm	0,771	2004150
ATKK 100-10	100	1.00 mm	1,141	2004151
ATKK 150-10	150	1.00 mm	1,250	2004152
ATKK 200-10	200	1.00 mm	2,013	2004153
ATKK 250-10	250	1.00 mm	2,434	2004154
ATKK 300-12	300	1.20 mm	3,430	2004155
ATKK 400-12	400	1.20 mm	4,453	2004156
ATKK 500-15	500	1.50 mm	6,824	2004157
ATKK 600-15	600	1.50 mm	8,156	2004158

W = GENİŞLİK = WIDTH / T = KALINLIK = THICKNESS

### SEPERATÖR / SEPERATOR

PREGALVANİZ (PG)  
PREGALVANIZED (PG)  
TS EN 10346

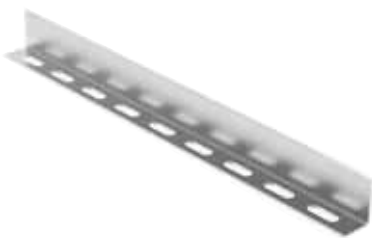

50

Sipariş Kodu Order Code	L (mm)	T (mm)	Ağırlık (kg/m) Weight (kg/m)	Barkod Kodu Barcode Code
50 ART SP-10	3.000	1.00 mm	0,628	2004170

85

Sipariş Kodu Order Code	L (mm)	T (mm)	Ağırlık (kg/m) Weight (kg/m)	Barkod Kodu Barcode Code
85 ART SP-10	3.000	1.00 mm	0,824	2004171

H100

Sipariş Kodu Order Code	L (mm)	T (mm)	Ağırlık (kg/m) Weight (kg/m)	Barkod Kodu Barcode Code
100 ART SP-1	3.000	1.00 mm	1,021	2004172

H = YÜKSEKLİK = HEIGHT / L = BOY = LENGTH / T = KALINLIK = THICKNESS

ARTIM METAL ELEKTRİK A.Ş.

\* Farklı kalınlık ve ölçülerde üretim yapılabılır.  
\* Malzeme ağırlıkları yaklaşık değerlerdir, ± %10 değişiklik gösterebilir.  
\* Malzeme kalınlık toleransı ± %10 dur.  
\* Lütfen siparişlerinizde sipariş kodu veya ürün kodu ve Kaplama şeklini belirtiniz.

\* We can produce cable trays different thickness and dimensions  
\* Cable trays are shown approximately weight, they could change ± %10 difference.  
\* Cable trays thickness tolerances are shown ± %10 .  
\* Please indicate order code and coating type in your orders.