

art

POWER CARRYING SOLUTIONS



TRUNKING TİP KABLO KANALLARI

TRUNKING TYPE CABLE TRAYS



H50 ATR SERIES

TRUNKING TIP KABLO KANALI

TRUNKING TYPE CABLE TRAYS

PREGALVANİZ (PG)
PREGALVANIZED (PG)
TS EN 10346



0.60 mm

Sipariş Kodu Order Code	W (mm)	T (mm)	Ağırlık (kg/m) Weight (kg/m)	Barkod Kodu Barcode Code
50 ATR 050-06	50	0.60 mm	0,772	2006000
ATRK 050-06	50	0.60 mm	0,377	2000800
50 ATR 075-06	75	0.60 mm	0,890	2006001
ATRK 075-06	75	0.60 mm	0,495	2000801
50 ATR 100-06	100	0.60 mm	1,008	2006002
ATRK 100-06	100	0.60 mm	0,612	2000802
50 ATR 150-06	150	0.60 mm	1,243	2006003
ATRK 150-06	150	0.60 mm	0,848	2000803
50 ATR 200-06	200	0.60 mm	1,479	2006004
ATRK 200-06	200	0.60 mm	1,083	2000804

0.80 mm

Sipariş Kodu Order Code	W (mm)	T (mm)	Ağırlık (kg/m) Weight (kg/m)	Barkod Kodu Barcode Code
50 ATR 050-08	50	0.80 mm	1,030	2006010
ATRK 050-08	50	0.80 mm	0,502	2000810
50 ATR 075-08	75	0.80 mm	1,187	2006011
ATRK 075-08	75	0.80 mm	0,659	2000811
50 ATR 100-08	100	0.80 mm	1,344	2006012
ATRK 100-08	100	0.80 mm	0,816	2000812
50 ATR 150-08	150	0.80 mm	1,658	2006013
ATRK 150-08	150	0.80 mm	1,130	2000813
50 ATR 200-08	200	0.80 mm	1,972	2006014
ATRK 200-08	200	0.80 mm	1,444	2000814

1.20 mm

Sipariş Kodu Order Code	W (mm)	T (mm)	Ağırlık (kg/m) Weight (kg/m)	Barkod Kodu Barcode Code
50 ATR 050-12	50	1.20 mm	1,545	2006020
ATRK 050-12	50	1.20 mm	0,754	2000820
50 ATR 075-12	75	1.20 mm	1,780	2006021
ATRK 075-12	75	1.20 mm	0,989	2000821
50 ATR 100-12	100	1.20 mm	2,016	2006022
ATRK 100-12	100	1.20 mm	1,225	2000822
50 ATR 150-12	150	1.20 mm	2,487	2006023
ATRK 150-12	150	1.20 mm	1,696	2000823
50 ATR 200-12	200	1.20 mm	2,958	2006024
ATRK 200-12	200	1.20 mm	2,167	2000824

1.50 mm

Sipariş Kodu Order Code	W (mm)	T (mm)	Ağırlık (kg/m) Weight (kg/m)	Barkod Kodu Barcode Code
50 ATR 050-15	50	1.50 mm	1,802	2006025
ATRK 050-15	50	1.50 mm	0,879	2000825
50 ATR 075-15	75	1.50 mm	2,077	2006026
ATRK 075-15	75	1.50 mm	1,154	2000826
50 ATR 100-15	100	1.50 mm	2,352	2006027
ATRK 100-15	100	1.50 mm	1,429	2000827
50 ATR 150-15	150	1.50 mm	2,901	2006028
ATRK 150-15	150	1.50 mm	1,978	2000828
50 ATR 200-15	200	1.50 mm	3,451	2006029
ATRK 200-15	200	1.50 mm	2,528	2000829

50 ATR 100-10

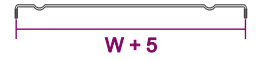
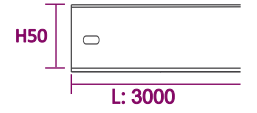
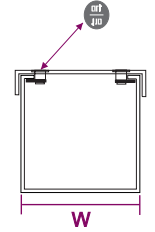

Standart uzunluk L:3000 mm
Toplu miktarlarda Özel ölçüler yapılabilir.
Standard Length L:3000 mm
Custom sizes can be made in bulk quantities.

ARTIM METAL ELEKTRİK A.Ş.

H = YÜKSEKLİK = HEIGHT / W = GENİŞLİK = WIDTH / T = KALINLIK = THICKNESS

* Farklı kalınlık ve ölçülerde üretim yapılabılır.
* Malzeme ağırlıkları yaklaşık değerlerdir, ± %10 değişiklik gösterebilir.
* Malzeme kalınlık toleransı ± %10 dur.
* Lütfen siparişlerinizde sipariş kodu veya ürün kodu ve Kaplama şeklini belirtiniz.

* We can produce cable trays different thickness and dimensions
* Cable trays are shown approximately weight, they could change ± %10 difference.
* Cable trays thickness tolerances are shown ± %10 .
* Please indicate order code and coating type in your orders.

H50 ATR SERIES

TRUNKING TIP KABLO KANALI

TRUNKING TYPE CABLE TRAYS

SICAK DALDIRMA (SD)

HOT DIP GALVANIZED (HDG)

TS EN ISO 1461

0.70 mm

Sipariş Kodu Order Code	W (mm)	T (mm)	Ağırlık (kg/m) Weight (kg/m)	Barkod Kodu Barcode Code
50 ATR 050-07	50	0.70 mm	0,982	2006005
ATRK 050-07	50	0.70 mm	0,479	2000805
50 ATR 075-07	75	0.70 mm	1,132	2006006
ATRK 075-07	75	0.70 mm	0,629	2000806
50 ATR 100-07	100	0.70 mm	1,282	2006007
ATRK 100-07	100	0.70 mm	0,779	2000807
50 ATR 150-07	150	0.70 mm	1,581	2006008
ATRK 150-07	150	0.70 mm	1,078	2000808
50 ATR 200-07	200	0.70 mm	1,881	2006009
ATRK 200-07	200	0.70 mm	1,378	2000809

1.00 mm

Sipariş Kodu Order Code	W (mm)	T (mm)	Ağırlık (kg/m) Weight (kg/m)	Barkod Kodu Barcode Code
50 ATR 050-10	50	1.00 mm	1,403	2006015
ATRK 050-10	50	1.00 mm	0,685	2000815
50 ATR 075-10	75	1.00 mm	1,617	2006016
ATRK 075-10	75	1.00 mm	0,898	2000816
50 ATR 100-10	100	1.00 mm	1,831	2006017
ATRK 100-10	100	1.00 mm	1,112	2000817
50 ATR 150-10	150	1.00 mm	2,259	2006018
ATRK 150-10	150	1.00 mm	1,540	2000818
50 ATR 200-10	200	1.00 mm	2,687	2006019
ATRK 200-10	200	1.00 mm	1,968	2000819

1.20 mm

Sipariş Kodu Order Code	W (mm)	T (mm)	Ağırlık (kg/m) Weight (kg/m)	Barkod Kodu Barcode Code
50 ATR 050-12	50	1.20 mm	1,684	2006020
ATRK 050-12	50	1.20 mm	0,821	2000820
50 ATR 075-12	75	1.20 mm	1,941	2006021
ATRK 075-12	75	1.20 mm	1,078	2000821
50 ATR 100-12	100	1.20 mm	2,197	2006022
ATRK 100-12	100	1.20 mm	1,335	2000822
50 ATR 150-12	150	1.20 mm	2,711	2006023
ATRK 150-12	150	1.20 mm	1,848	2000823
50 ATR 200-12	200	1.20 mm	3,224	2006024
ATRK 200-12	200	1.20 mm	2,362	2000824

1.50 mm

Sipariş Kodu Order Code	W (mm)	T (mm)	Ağırlık (kg/m) Weight (kg/m)	Barkod Kodu Barcode Code
50 ATR 050-15	50	1.50 mm	1,965	2006025
ATRK 050-15	50	1.50 mm	0,958	2000825
50 ATR 075-15	75	1.50 mm	2,264	2006026
ATRK 075-15	75	1.50 mm	1,258	2000826
50 ATR 100-15	100	1.50 mm	2,564	2006027
ATRK 100-15	100	1.50 mm	1,557	2000827
50 ATR 150-15	150	1.50 mm	3,162	2006028
ATRK 150-15	150	1.50 mm	2,156	2000828
50 ATR 200-15	200	1.50 mm	3,761	2006029
ATRK 200-15	200	1.50 mm	2,755	2000829

H = YÜKSEKLİK = HEIGHT / W = GENİŞLİK = WIDTH / T = KALINLIK = THICKNESS

50 ATR 100-10

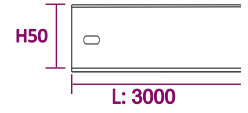
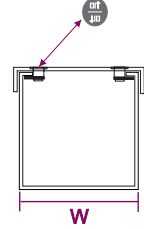

Standart uzunluk L:3000 mm
Toplu miktarlarda Özel ölçüler yapılabilir.
Standard Length L:3000 mm
Custom sizes can be made in bulk quantities.



* Farklı kalınlık ve ölçülerde üretim yapılabılır.
* Malzeme ağırlıkları yaklaşık değerlerdir, ± %10 değişiklik gösterebilir.
* Malzeme kalınlık toleransı ± %10 dur.
* Lütfen siparişlerinizde sipariş kodu veya ürün kodu ve Kaplama şeklini belirtiniz.

* We can produce cable trays different thickness and dimensions
* Cable trays are shown approximately weight, they could change ± %10 difference.
* Cable trays thickness tolerances are shown ± %10 .
* Please indicate order code and coating type in your orders.

H75 ATR SERIES

TRUNKING TIP KABLO KANALI

TRUNKING TYPE CABLE TRAYS

PREGALVANIZ (PG)
PREGALVANIZED (PG)
TS EN 10346



0.60 mm

Sipariş Kodu Order Code	W (mm)	T (mm)	Ağırlık (kg/m) Weight (kg/m)	Barkod Kodu Barcode Code
75 ATR 075-06	75	0.60 mm	1,126	2006030
ATRK 075-06	75	0.60 mm	0,495	2000801
75 ATR 100-06	100	0.60 mm	1,243	2006031
ATRK 100-06	100	0.60 mm	0,612	2000802
75 ATR 150-06	150	0.60 mm	1,479	2006032
ATRK 150-06	150	0.60 mm	0,848	2000803
75 ATR 200-06	200	0.60 mm	1,714	2006033
ATRK 200-06	200	0.60 mm	1,083	2000804

0.80 mm

Sipariş Kodu Order Code	W (mm)	T (mm)	Ağırlık (kg/m) Weight (kg/m)	Barkod Kodu Barcode Code
75 ATR 075-08	75	0.80 mm	1,501	2006038
ATRK 075-08	75	0.80 mm	0,659	2000811
75 ATR 100-08	100	0.80 mm	1,658	2006039
ATRK 100-08	100	0.80 mm	0,816	2000812
75 ATR 150-08	150	0.80 mm	1,972	2006040
ATRK 150-08	150	0.80 mm	1,130	2000813
75 ATR 200-08	200	0.80 mm	2,286	2006041
ATRK 200-08	200	0.80 mm	1,444	2000814

1.20 mm

Sipariş Kodu Order Code	W (mm)	T (mm)	Ağırlık (kg/m) Weight (kg/m)	Barkod Kodu Barcode Code
75 ATR 075-12	75	1.20 mm	2,251	2006046
ATRK 075-12	75	1.20 mm	0,989	2000821
75 ATR 100-12	100	1.20 mm	2,487	2006047
ATRK 100-12	100	1.20 mm	1,225	2000822
75 ATR 150-12	150	1.20 mm	2,958	2006048
ATRK 150-12	150	1.20 mm	1,696	2000823
75 ATR 200-12	200	1.20 mm	3,429	2006049
ATRK 200-12	200	1.20 mm	2,167	2000824

1.50 mm

Sipariş Kodu Order Code	W (mm)	T (mm)	Ağırlık (kg/m) Weight (kg/m)	Barkod Kodu Barcode Code
75 ATR 075-15	75	1.50 mm	2,627	2006050
ATRK 075-15	75	1.50 mm	1,154	2000826
75 ATR 100-15	100	1.50 mm	2,901	2006051
ATRK 100-15	100	1.50 mm	1,429	2000827
75 ATR 150-15	150	1.50 mm	3,451	2006052
ATRK 150-15	150	1.50 mm	1,978	2000828
75 ATR 200-15	200	1.50 mm	4,000	2006053
ATRK 200-15	200	1.50 mm	2,528	2000829

H = YÜKSEKLİK = HEIGHT / W = GENİŞLİK = WIDTH / T = KALINLIK = THICKNESS

75 ATR 100-10

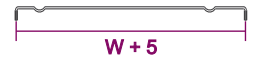
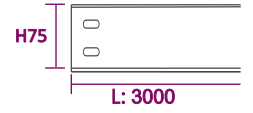
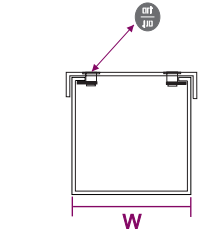

Standart uzunluk L:3000 mm
Toplu miktarlarda Özel ölçüler yapılabilir.
Standard Length L:3000 mm
Custom sizes can be made in bulk quantities.

ARTIM METAL ELEKTRİK A.Ş.

* Farklı kalınlık ve ölçülerde üretim yapılabılır.
* Malzeme ağırlıkları yaklaşık değerlerdir, \pm %10 değişiklik gösterebilir.
* Malzeme kalınlık toleransı \pm %10 dur.
* Lütfen siparişlerinizde sipariş kodu veya ürün kodu ve Kaplama şeklini belirtiniz.

* We can produce cable trays different thickness and dimensions
* Cable trays are shown approximately weight, they could change \pm %10 difference.
* Cable trays thickness tolerances are shown \pm %10 .
* Please indicate order code and coating type in your orders.

H75 ATR SERIES

TRUNKING TIP KABLO KANALI

TRUNKING TYPE CABLE TRAYS

SICAK DALDIRMA (SD)

HOT DIP GALVANIZED (HDG)

TS EN ISO 1461

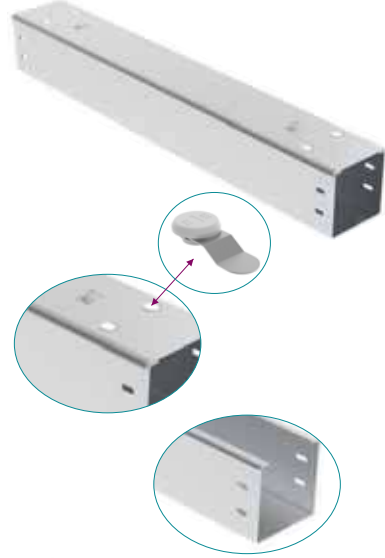

0.70 mm

Sipariş Kodu Order Code	W (mm)	T (mm)	Ağırlık (kg/m) Weight (kg/m)	Barkod Kodu Barcode Code
75 ATTK 075-07	75	0.70 mm	1,432	2006034
AKK 075-07	75	0.70 mm	0,629	2000806
75 ATTK 100-07	100	0.70 mm	1,581	2006035
AKK 100-07	100	0.70 mm	0,779	2000807
75 ATTK 150-07	150	0.70 mm	1,881	2006036
AKK 150-07	150	0.70 mm	1,078	2000808
75 ATTK 200-07	200	0.70 mm	2,180	2006037
AKK 200-07	200	0.70 mm	1,378	2000809

1.00 mm

Sipariş Kodu Order Code	W (mm)	T (mm)	Ağırlık (kg/m) Weight (kg/m)	Barkod Kodu Barcode Code
75 ATTK 075-10	75	1.00 mm	2,045	2006042
AKK 075-10	75	1.00 mm	0,898	2000816
75 ATTK 100-10	100	1.00 mm	2,259	2006043
AKK 100-10	100	1.00 mm	1,112	2000817
75 ATTK 150-10	150	1.00 mm	2,687	2006044
AKK 150-10	150	1.00 mm	1,540	2000818
75 ATTK 200-10	200	1.00 mm	3,115	2006045
AKK 200-10	200	1.00 mm	1,968	2000819

1.20 mm

Sipariş Kodu Order Code	W (mm)	T (mm)	Ağırlık (kg/m) Weight (kg/m)	Barkod Kodu Barcode Code
75 ATTK 075-12	75	1.20 mm	2,454	2006046
AKK 075-12	75	1.20 mm	1,078	2000821
75 ATTK 100-12	100	1.20 mm	2,711	2006047
AKK 100-12	100	1.20 mm	1,335	2000822
75 ATTK 150-12	150	1.20 mm	3,224	2006048
AKK 150-12	150	1.20 mm	1,848	2000823
75 ATTK 200-12	200	1.20 mm	3,737	2006049
AKK 200-12	200	1.20 mm	2,362	2000824

1.50 mm

Sipariş Kodu Order Code	W (mm)	T (mm)	Ağırlık (kg/m) Weight (kg/m)	Barkod Kodu Barcode Code
75 ATTK 075-15	75	1.50 mm	2,863	2006050
AKK 075-15	75	1.50 mm	1,258	2000826
75 ATTK 100-15	100	1.50 mm	3,162	2006051
AKK 100-15	100	1.50 mm	1,557	2000827
75 ATTK 150-15	150	1.50 mm	3,761	2006052
AKK 150-15	150	1.50 mm	2,156	2000828
75 ATTK 200-15	200	1.50 mm	4,360	2006053
AKK 200-15	200	1.50 mm	2,755	2000829

H = YÜKSEKLİK = HEIGHT / W = GENİŞLİK = WIDTH / T = KALINLIK = THICKNESS

75 ATR 100-10

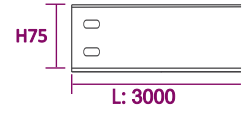
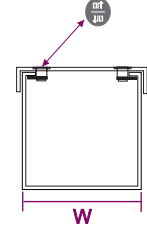

Standart uzunluk L:3000 mm
Toplu miktarlarda Özel ölçüler yapılabilir.
Standard Length L:3000 mm
Custom sizes can be made in bulk quantities.

* Farklı kalınlık ve ölçülerde üretim yapılabılır.
* Malzeme ağırlıkları yaklaşık değerlerdir, ± %10 değişiklik gösterebilir.
* Malzeme kalınlık toleransı ± %10 dur.
* Lütfen siparişlerinizde sipariş kodu veya ürün kodu ve Kaplama şeklini belirtiniz.

* We can produce cable trays different thickness and dimensions
* Cable trays are shown approximately weight, they could change ± %10 difference.
* Cable trays thickness tolerances are shown ± %10 .
* Please indicate order code and coating type in your orders.

H100 ATR SERIES

TRUNKING TIP KABLO KANALLARI

TRUNKING TYPE CABLE TRAYS

PREGALVANIZ (PG)
PREGALVANIZED (PG)
TS EN 10346

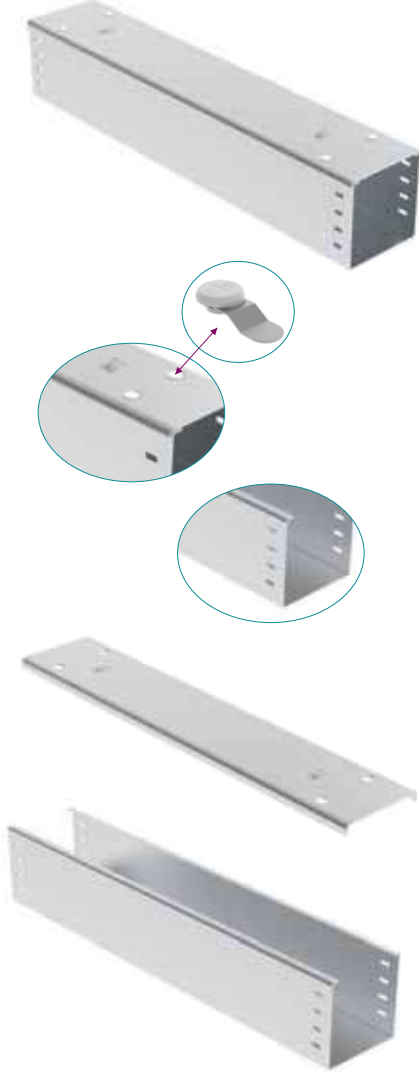

0.60 mm

Sipariş Kodu Order Code	W (mm)	T (mm)	Ağırlık (kg/m) Weight (kg/m)	Barkod Kodu Barcode Code
100 ATR 100-06	100	0.60 mm	1,479	2006054
ATRK 100-06	100	0.60 mm	0,612	2000802
100 ATR 150-06	150	0.60 mm	1,714	2006055
ATRK 150-06	150	0.60 mm	0,848	2000803
100 ATR 200-06	200	0.60 mm	1,950	2006056
ATRK 200-06	200	0.60 mm	1,083	2000804

0.80 mm

Sipariş Kodu Order Code	W (mm)	T (mm)	Ağırlık (kg/m) Weight (kg/m)	Barkod Kodu Barcode Code
100 ATR 100-08	100	0.80 mm	1,972	2006057
ATRK 100-08	100	0.80 mm	0,816	2000812
100 ATR 150-08	150	0.80 mm	2,286	2006058
ATRK 150-08	150	0.80 mm	1,130	2000813
100 ATR 200-08	200	0.80 mm	2,600	2006059
ATRK 200-08	200	0.80 mm	1,444	2000814

1.00 mm

Sipariş Kodu Order Code	W (mm)	T (mm)	Ağırlık (kg/m) Weight (kg/m)	Barkod Kodu Barcode Code
100 ATR 100-10	100	1.00 mm	2,465	2006060
ATRK 100-10	100	1.00 mm	1,021	2000817
100 ATR 150-10	150	1.00 mm	2,857	2006061
ATRK 150-10	150	1.00 mm	1,413	2000818
100 ATR 200-10	200	1.00 mm	3,250	2006062
ATRK 200-10	200	1.00 mm	1,806	2000819

1.20 mm

Sipariş Kodu Order Code	W (mm)	T (mm)	Ağırlık (kg/m) Weight (kg/m)	Barkod Kodu Barcode Code
100 ATR 100-12	100	1.20 mm	2,958	2006063
ATRK 100-12	100	1.20 mm	1,225	2000822
100 ATR 150-12	150	1.20 mm	3,429	2006064
ATRK 150-12	150	1.20 mm	1,696	2000823
100 ATR 200-12	200	1.20 mm	3,900	2006065
ATRK 200-12	200	1.20 mm	2,167	2000824

1.50 mm

Sipariş Kodu Order Code	W (mm)	T (mm)	Ağırlık (kg/m) Weight (kg/m)	Barkod Kodu Barcode Code
100 ATR 100-15	100	1.50 mm	3,451	2006066
ATRK 100-15	100	1.50 mm	1,429	2000827
100 ATR 150-15	150	1.50 mm	4,000	2006067
ATRK 150-15	150	1.50 mm	1,978	2000828
100 ATR 200-15	200	1.50 mm	4,550	2006068
ATRK 200-15	200	1.50 mm	2,528	2000829

H = YÜKSEKLİK = HEIGHT / W = GENİŞLİK = WIDTH / T = KALINLIK = THICKNESS

100 ATR 150-10

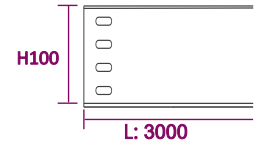
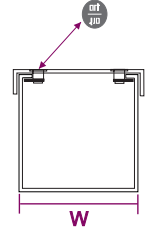

Standart uzunluk L:3000 mm
Toplu miktarlarda Özel ölçüler yapılabilir.
Standard Length L:3000 mm
Custom sizes can be made in bulk quantities.

ARTIM METAL ELEKTRİK A.Ş.

* Farklı kalınlık ve ölçülerde üretim yapılabılır.
* Malzeme ağırlıkları yaklaşık değerlerdir, \pm %10 değişiklik gösterebilir.
* Malzeme kalınlık toleransı \pm %10 dur.
* Lütfen siparişlerinizde sipariş kodu veya ürün kodu ve Kaplama şeklini belirtiniz.

* We can produce cable trays different thickness and dimensions
* Cable trays are shown approximately weight, they could change \pm %10 difference.
* Cable trays thickness tolerances are shown \pm %10 .
* Please indicate order code and coating type in your orders.

H100 ATR SERIES

TRUNKING TIP KABLO KANALI

TRUNKING TYPE CABLE TRAYS

SICAK DALDIRMA (SD)

HOT DIP GALVANIZED (HDG)

TS EN ISO 1461

0.80 mm

Sipariş Kodu Order Code	W (mm)	T (mm)	Ağırlık (kg/m) Weight (kg/m)	Barkod Kodu Barcode Code
100 ATR 100-08	100	0.80 mm	2,149	2006057
ATRK 100-08	100	0.80 mm	0,890	2000812
100 ATR 150-08	150	0.80 mm	2,492	2006058
ATRK 150-08	150	0.80 mm	1,232	2000813
100 ATR 200-08	200	0.80 mm	2,834	2006059
ATRK 200-08	200	0.80 mm	1,574	2000814

1.00 mm

Sipariş Kodu Order Code	W (mm)	T (mm)	Ağırlık (kg/m) Weight (kg/m)	Barkod Kodu Barcode Code
100 ATR 100-10	100	1.00 mm	2,687	2006060
ATRK 100-10	100	1.00 mm	1,112	2000817
100 ATR 150-10	150	1.00 mm	3,115	2006061
ATRK 150-10	150	1.00 mm	1,540	2000818
100 ATR 200-10	200	1.00 mm	3,542	2006062
ATRK 200-10	200	1.00 mm	1,968	2000819

1.20 mm

Sipariş Kodu Order Code	W (mm)	T (mm)	Ağırlık (kg/m) Weight (kg/m)	Barkod Kodu Barcode Code
100 ATR 100-12	100	1.20 mm	3,224	2006063
ATRK 100-12	100	1.20 mm	1,335	2000822
100 ATR 150-12	150	1.20 mm	3,737	2006064
ATRK 150-12	150	1.20 mm	1,848	2000823
100 ATR 200-12	200	1.20 mm	4,251	2006065
ATRK 200-12	200	1.20 mm	2,362	2000824

1.50 mm

Sipariş Kodu Order Code	W (mm)	T (mm)	Ağırlık (kg/m) Weight (kg/m)	Barkod Kodu Barcode Code
100 ATR 100-15	100	1.50 mm	3,761	2006066
ATRK 100-15	100	1.50 mm	1,557	2000827
100 ATR 150-15	150	1.50 mm	4,360	2006067
ATRK 150-15	150	1.50 mm	2,156	2000828
100 ATR 200-15	200	1.50 mm	4,959	2006068
ATRK 200-15	200	1.50 mm	2,755	2000829

2.00 mm

Sipariş Kodu Order Code	W (mm)	T (mm)	Ağırlık (kg/m) Weight (kg/m)	Barkod Kodu Barcode Code
100 ATR 100-20	100	2.00 mm	5,014	2006081
ATRK 100-20	100	2.00 mm	2,076	2000830
100 ATR 150-20	150	2.00 mm	5,813	2006082
ATRK 150-20	150	2.00 mm	2,874	2000831
100 ATR 200-20	200	2.00 mm	6,612	2006083
ATRK 200-20	200	2.00 mm	3,673	2000832

H = YÜKSEKLİK = HEIGHT / W = GENİŞLİK = WIDTH / T = KALINLIK = THICKNESS

100 ATR 150-10

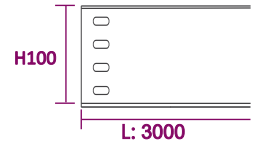
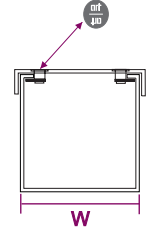
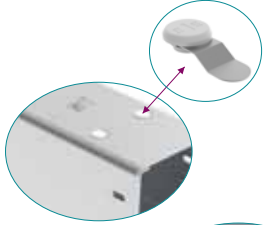

Standart uzunluk L:3000 mm
Toplu miktarlarda Özel ölçüler yapılabilir.
Standard Length L:3000 mm
Custom sizes can be made in bulk quantities.

* Farklı kalınlık ve ölçülerde üretim yapılabılır.
* Malzeme ağırlıkları yaklaşık değerlerdir, \pm %10 değişiklik gösterebilir.
* Malzeme kalınlık toleransı \pm %10 dur.
* Lütfen siparişlerinizde sipariş kodu veya ürün kodu ve Kaplama şeklini belirtiniz.

* We can produce cable trays different thickness and dimensions
* Cable trays are shown approximately weight, they could change \pm %10 difference.
* Cable trays thickness tolerances are shown \pm %10 .
* Please indicate order code and coating type in your orders.

H150 ATR SERIES

TRUNKING TIP KABLO KANALLARI

TRUNKING TYPE CABLE TRAYS

PREGALVANİZ (PG)
PREGALVANIZED (PG)
TS EN 10346

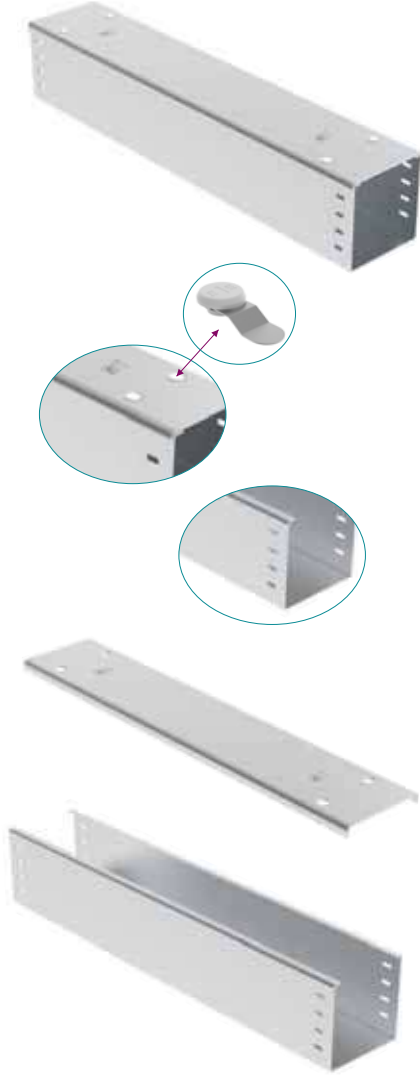

0.60 mm

Sipariş Kodu Order Code	W (mm)	T (mm)	Ağırlık (kg/m) Weight (kg/m)	Barkod Kodu Barcode Code
150 ATR 150-06	150	0.60 mm	2,185	2006069
ATRK 150-06	150	0.60 mm	0,848	2000803
150 ATR 200-06	200	0.60 mm	2,421	2006070
ATRK 200-06	200	0.60 mm	1,083	2000804

0.80 mm

Sipariş Kodu Order Code	W (mm)	T (mm)	Ağırlık (kg/m) Weight (kg/m)	Barkod Kodu Barcode Code
150 ATR 150-08	150	0.80 mm	2,914	2006071
ATRK 150-08	150	0.80 mm	1,130	2000813
150 ATR 200-08	200	0.80 mm	3,228	2006072
ATRK 200-08	200	0.80 mm	1,444	2000814

1.00 mm

Sipariş Kodu Order Code	W (mm)	T (mm)	Ağırlık (kg/m) Weight (kg/m)	Barkod Kodu Barcode Code
150 ATR 150-10	150	1.00 mm	3,642	2006073
ATRK 150-10	150	1.00 mm	1,413	2000818
150 ATR 200-10	200	1.00 mm	4,035	2006074
ATRK 200-10	200	1.00 mm	1,806	2000819

1.20 mm

Sipariş Kodu Order Code	W (mm)	T (mm)	Ağırlık (kg/m) Weight (kg/m)	Barkod Kodu Barcode Code
150 ATR 150-12	150	1.20 mm	4,371	2006075
ATRK 150-12	150	1.20 mm	1,696	2000823
150 ATR 200-12	200	1.20 mm	4,842	2006076
ATRK 200-12	200	1.20 mm	2,167	2000824

1.50 mm

Sipariş Kodu Order Code	W (mm)	T (mm)	Ağırlık (kg/m) Weight (kg/m)	Barkod Kodu Barcode Code
150 ATR 150-15	150	1.50 mm	5,099	2006077
ATRK 150-15	150	1.50 mm	1,978	2000828
150 ATR 200-15	200	1.50 mm	5,649	2006078
ATRK 200-15	200	1.50 mm	2,528	2000829

H = YÜKSEKLİK = HEIGHT / W = GENİŞLİK = WIDTH / T = KALINLIK = THICKNESS

150 ATR 150-10

Yükseklik | Kanal Tipi | Genişlik | Kalınlık
Height | Type | Width | Thickness

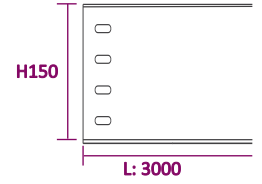
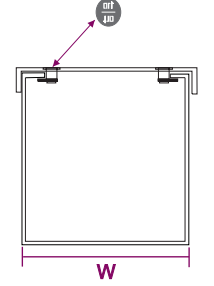

Standart uzunluk L:3000 mm
Toplu miktarlarda Özel ölçüler yapılabilir.
Standard Length L:3000 mm
Custom sizes can be made in bulk quantities.

ARTIM METAL ELEKTRİK A.Ş.

* Farklı kalınlık ve ölçülerde üretim yapılabilir.
* Malzeme ağırlıkları yaklaşık değerlerdir, \pm %10 değişiklik gösterebilir.
* Malzeme kalınlık toleransı \pm %10 dur.
* Lütfen siparişlerinizde sipariş kodu veya ürün kodu ve Kaplama şeklini belirtiniz.

* We can produce cable trays different thickness and dimensions
* Cable trays are shown approximately weight, they could change \pm %10 difference.
* Cable trays thickness tolerances are shown \pm %10 .
* Please indicate order code and coating type in your orders.

H150 ATR SERIES

TRUNKING TIP KABLO KANALI

TRUNKING TYPE CABLE TRAYS

SICAK DALDIRMA (SD)

HOT DIP GALVANIZED (HDG)

TS EN ISO 1461

0.80 mm

Sipariş Kodu Order Code	W (mm)	T (mm)	Ağırlık (kg/m) Weight (kg/m)	Barkod Kodu Barcode Code
150 ATR 150-08	150	0.80 mm	3,176	2006071
ATRK 150-08	150	0.80 mm	1,232	2000813
150 ATR 200-08	200	0.80 mm	3,518	2006072
ATRK 200-08	200	0.80 mm	1,574	2000814

1.00 mm

Sipariş Kodu Order Code	W (mm)	T (mm)	Ağırlık (kg/m) Weight (kg/m)	Barkod Kodu Barcode Code
150 ATR 150-10	150	1.00 mm	3,970	2006073
ATRK 150-10	150	1.00 mm	1,540	2000818
150 ATR 200-10	200	1.00 mm	4,398	2006074
ATRK 200-10	200	1.00 mm	1,968	2000819

1.20 mm

Sipariş Kodu Order Code	W (mm)	T (mm)	Ağırlık (kg/m) Weight (kg/m)	Barkod Kodu Barcode Code
150 ATR 150-12	150	1.20 mm	4,764	2006075
ATRK 150-12	150	1.20 mm	1,848	2000823
150 ATR 200-12	200	1.20 mm	5,278	2006076
ATRK 200-12	200	1.20 mm	2,362	2000824

1.50 mm

Sipariş Kodu Order Code	W (mm)	T (mm)	Ağırlık (kg/m) Weight (kg/m)	Barkod Kodu Barcode Code
150 ATR 150-15	150	1.50 mm	5,558	2006077
ATRK 150-15	150	1.50 mm	2,156	2000828
150 ATR 200-15	200	1.50 mm	6,157	2006078
ATRK 200-15	200	1.50 mm	2,755	2000829

2.00 mm

Sipariş Kodu Order Code	W (mm)	T (mm)	Ağırlık (kg/m) Weight (kg/m)	Barkod Kodu Barcode Code
150 ATR 150-20	150	2.00 mm	7,410	2006084
ATRK 150-20	150	2.00 mm	2,874	2000833
150 ATR 200-20	200	2.00 mm	8,209	2006085
ATRK 200-20	200	2.00 mm	3,673	2000834

H = YÜKSEKLİK = HEIGHT / W = GENİŞLİK = WIDTH / T = KALINLIK = THICKNESS

150 ATR 150-10

Yükseklik | Kanal Tipi | Genişlik | Kalınlık
Height | Type | Width | Thickness

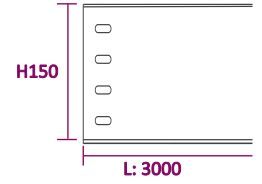
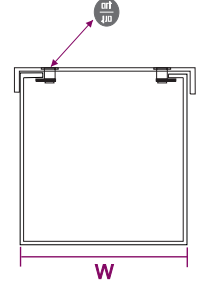

Standart uzunluk L:3000 mm
Toplu miktarlarda Özel ölçüler yapılabilir.
Standard Length L:3000 mm
Custom sizes can be made in bulk quantities.

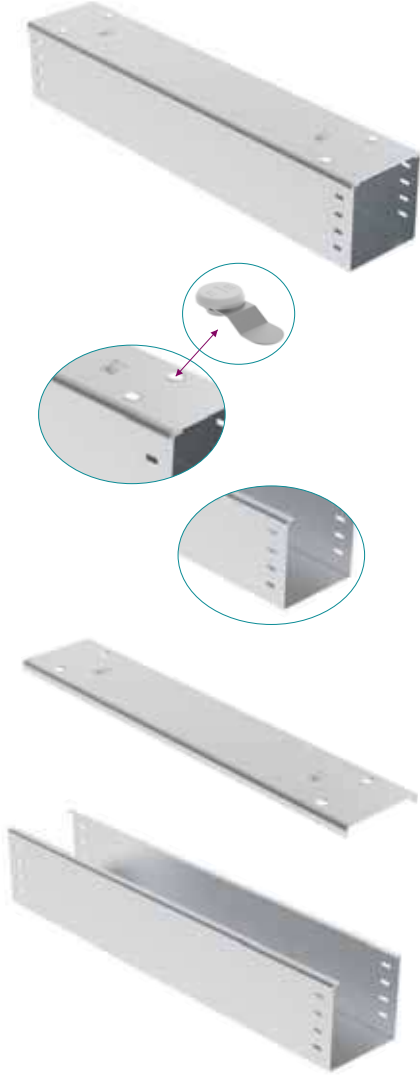

* Farklı kalınlık ve ölçülerde üretim yapıla bilinir.
* Malzeme ağırlıkları yaklaşık değerlerdir, ± %10 değişiklik gösterebilir.
* Malzeme kalınlık toleransı ± %10 dur.
* Lütfen siparişlerinizde sipariş kodu veya ürün kodu ve Kaplama şeklini belirtiniz.

* We can produce cable trays different thickness and dimensions
* Cable trays are shown approximately weight, they could change ± %10 difference.
* Cable trays thickness tolerances are shown ± %10 .
* Please indicate order code and coating type in your orders.

ATR SERIES

90° YATAY DÖNÜS

90° BEND

PREGALVANIZ (PG)
PREGALVANIZED (PG)
TS EN 10346



H50 = Tek delikli
H50 = One hole

H75 = İki delikli
H75 = Two holes

H100 = H150 = Dört delikli
H100 = H150 = Four holes



H50

Sipariş Kodu Order Code	W (mm)	T (mm)	Ağırlık (kg/ad) Weight (kg/pcs)	Barkod Kodu Barcode Code
50 ATR 050Y	50	1.20 mm	0,230	2006100
ATRK 050Y	50	1.20 mm	0,120	2006600
50 ATR 075Y	75	1.20 mm	0,396	2006101
ATRK 075Y	75	1.20 mm	0,190	2006601
50 ATR 100Y	100	1.20 mm	0,594	2006102
ATRK 100Y	100	1.20 mm	0,245	2006602
50 ATR 150Y	150	1.20 mm	0,785	2006103
ATRK 150Y	150	1.20 mm	0,455	2006603
50 ATR 200Y	200	1.20 mm	1,091	2006104
ATRK 200Y	200	1.20 mm	0,635	2006604

H75

Sipariş Kodu Order Code	W (mm)	T (mm)	Ağırlık (kg/ad) Weight (kg/pcs)	Barkod Kodu Barcode Code
75 ATR 075Y	75	1.20 mm	0,549	2006105
ATRK 075Y	75	1.20 mm	0,190	2006601
75 ATR 100Y	100	1.20 mm	0,747	2006106
ATRK 100Y	100	1.20 mm	0,245	2006602
75 ATR 150Y	150	1.20 mm	0,942	2006107
ATRK 150Y	150	1.20 mm	0,455	2006603
75 ATR 200Y	200	1.20 mm	1,258	2006108
ATRK 200Y	200	1.20 mm	0,635	2006604

H100

Sipariş Kodu Order Code	W (mm)	T (mm)	Ağırlık (kg/ad) Weight (kg/pcs)	Barkod Kodu Barcode Code
100 ATR 100Y	100	1.20 mm	0,810	2006109
ATRK 100Y	100	1.20 mm	0,245	2006602
100 ATR 150Y	150	1.20 mm	1,087	2006110
ATRK 150Y	150	1.20 mm	0,455	2006603
100 ATR 200Y	200	1.20 mm	1,458	2006111
ATRK 200Y	200	1.20 mm	0,635	2006604

H150

Sipariş Kodu Order Code	W (mm)	T (mm)	Ağırlık (kg/ad) Weight (kg/pcs)	Barkod Kodu Barcode Code
150 ATR 150Y	150	1.20 mm	1,884	2006112
ATRK 150Y	150	1.20 mm	0,455	2006603
150 ATR 200Y	200	1.20 mm	2,516	2006113
ATRK 200Y	200	1.20 mm	0,635	2006604

H = YÜKSEKLİK = HEIGHT / W = GENİŞLİK = WIDTH / T = KALINLIK = THICKNESS

H ATR 100 Y

Yükseklik Height	Kanal Tipi Type	Genişlik Width	Modül Module
---------------------	--------------------	-------------------	-----------------

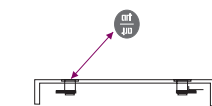
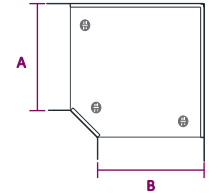
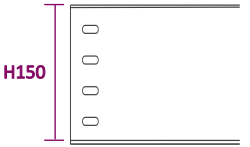
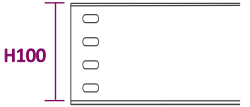
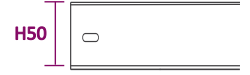

Dönüşlerde "A-B" ölçüleri esit olarak üretilmektedir. İsteğe bağlı olarak farklı ölçülerde üretim yapılır. Bends are produced same dimension for "A-B" as well as we can produce special dimensions regarding your inquiry.

ARTIM METAL ELEKTRİK A.Ş.

* Farklı kalınlık ve ölçülerde üretim yapılabılır.
* Malzeme ağırlıkları yaklaşık değerlerdir, ± %10 değişiklik gösterebilir.
* Malzeme kalınlık toleransı ± %10 dur.
* Lütfen siparişlerinizde sipariş kodu veya ürün kodu ve Kaplama şeklini belirtiniz.

* We can produce cable trays different thickness and dimensions
* Cable trays are shown approximately weight, they could change ± %10 difference.
* Cable trays thickness tolerances are shown ± %10 .
* Please indicate order code and coating type in your orders.

ATR SERIES

90° YATAY DÖNÜS

90° BEND

SICAK DALDIRMA (SD)

HOT DIP GALVANIZED (HDG)

TS EN ISO 1461



H50 = Tek delikli

H50 = One hole

H75 = İki delikli

H75 = Two holes

H100 = H150 = Dört delikli

H100 = H150 = Four holes



H50

Sipariş Kodu Order Code	W (mm)	T (mm)	Ağırlık (kg/ad) Weight (kg/pcs)	Barkod Kodu Barcode Code
50 ATR 050Y	50	1.50 mm	0,253	2006100
ATRK 050Y	50	1.50 mm	0,132	2006600
50 ATR 075Y	75	1.50 mm	0,436	2006101
ATRK 075Y	75	1.50 mm	0,209	2006601
50 ATR 100Y	100	1.50 mm	0,653	2006102
ATRK 100Y	100	1.50 mm	0,270	2006602
50 ATR 150Y	150	1.50 mm	0,864	2006103
ATRK 150Y	150	1.50 mm	0,501	2006603
50 ATR 200Y	200	1.50 mm	1,200	2006104
ATRK 200Y	200	1.50 mm	0,699	2006604

H75

Sipariş Kodu Order Code	W (mm)	T (mm)	Ağırlık (kg/ad) Weight (kg/pcs)	Barkod Kodu Barcode Code
75 ATR 075Y	75	1.50 mm	0,604	2006105
ATRK 075Y	75	1.50 mm	0,209	2006601
75 ATR 100Y	100	1.50 mm	0,822	2006106
ATRK 100Y	100	1.50 mm	0,270	2006602
75 ATR 150Y	150	1.50 mm	1,036	2006107
ATRK 150Y	150	1.50 mm	0,501	2006603
75 ATR 200Y	200	1.50 mm	1,384	2006108
ATRK 200Y	200	1.50 mm	0,699	2006604

H100

Sipariş Kodu Order Code	W (mm)	T (mm)	Ağırlık (kg/ad) Weight (kg/pcs)	Barkod Kodu Barcode Code
100 ATR 100Y	100	1.50 mm	0,891	2006109
ATRK 100Y	100	1.50 mm	0,270	2006602
100 ATR 150Y	150	1.50 mm	1,196	2006110
ATRK 150Y	150	1.50 mm	0,501	2006603
100 ATR 200Y	200	1.50 mm	1,604	2006111
ATRK 200Y	200	1.50 mm	0,699	2006604

H150

Sipariş Kodu Order Code	W (mm)	T (mm)	Ağırlık (kg/ad) Weight (kg/pcs)	Barkod Kodu Barcode Code
150 ATR 150Y	150	1.50 mm	2,072	2006112
ATRK 150Y	150	1.50 mm	0,501	2006603
150 ATR 200Y	200	1.50 mm	2,768	2006113
ATRK 200Y	200	1.50 mm	0,699	2006604

H = YÜKSEKLİK = HEIGHT / W = GENİŞLİK = WIDTH / T = KALINLIK = THICKNESS

H ATR 100 Y

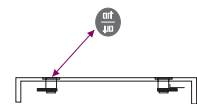
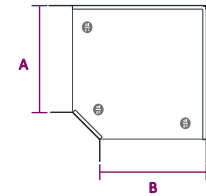
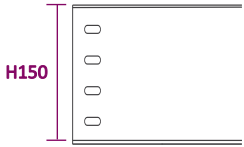
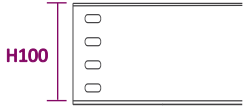
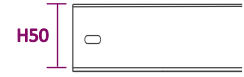

Dönüşlerde "A-B" ölçüleri esit olarak üretilmektedir. İsteğe bağlı olarak farklı ölçülerde üretim yapılır. Bends are produced same dimension for "A-B" as well as we can produce special dimensions regarding your inquiry.

* Farklı kalınlık ve ölçülerde üretim yapılabılır.
* Malzeme ağırlıkları yaklaşık değerlerdir, ± %10 değişiklik gösterebilir.
* Malzeme kalınlık toleransı ± %10 dur.
* Lütfen siparişlerinizde sipariş kodu veya ürün kodu ve Kaplama şeklini belirtiniz.

* We can produce cable trays different thickness and dimensions
* Cable trays are shown approximately weight, they could change ± %10 difference.
* Cable trays thickness tolerances are shown ± %10 .
* Please indicate order code and coating type in your orders.

ATR SERIES

T BAGLANTI

T BEND

PREGALVANIZ (PG)
PREGALVANIZED (PG)
TS EN 10346



H50 = Tek delikli
H50 = One hole

H75 = İki delikli
H75 = Two holes

H100 = H150 = Dört delikli
H100 = H150 = Four holes



H50

Sipariş Kodu Order Code	W (mm)	T (mm)	Ağırlık (kg/ad) Weight (kg/pcs)	Barkod Kodu Barcode Code
50 ATR 050T	50	1.20 mm	0,302	2006200
ATRK 050T	50	1.20 mm	0,140	2006700
50 ATR 075T	75	1.20 mm	0,453	2006201
ATRK 075T	75	1.20 mm	0,210	2006701
50 ATR 100T	100	1.20 mm	0,716	2006202
ATRK 100T	100	1.20 mm	0,290	2006702
50 ATR 150T	150	1.20 mm	0,893	2006203
ATRK 150T	150	1.20 mm	0,530	2006703
50 ATR 200T	200	1.20 mm	1,202	2006204
ATRK 200T	200	1.20 mm	0,775	2006704

H75

Sipariş Kodu Order Code	W (mm)	T (mm)	Ağırlık (kg/ad) Weight (kg/pcs)	Barkod Kodu Barcode Code
75 ATR 075T	75	1.20 mm	0,667	2006205
ATRK 075T	75	1.20 mm	0,210	2006701
75 ATR 100T	100	1.20 mm	0,889	2006206
ATRK 100T	100	1.20 mm	0,290	2006702
75 ATR 150T	150	1.20 mm	1,065	2006207
ATRK 150T	150	1.20 mm	0,530	2006703
75 ATR 200T	200	1.20 mm	1,382	2006208
ATRK 200T	200	1.20 mm	0,775	2006704

H100

Sipariş Kodu Order Code	W (mm)	T (mm)	Ağırlık (kg/ad) Weight (kg/pcs)	Barkod Kodu Barcode Code
100 ATR 100T	100	1.20 mm	1,026	2006209
ATRK 100T	100	1.20 mm	0,290	2006702
100 ATR 150T	150	1.20 mm	1,202	2006210
ATRK 150T	150	1.20 mm	0,530	2006703
100 ATR 200T	200	1.20 mm	1,559	2006211
ATRK 200T	200	1.20 mm	0,775	2006704

H150

Sipariş Kodu Order Code	W (mm)	T (mm)	Ağırlık (kg/ad) Weight (kg/pcs)	Barkod Kodu Barcode Code
150 ATR 150T	150	1.20 mm	1,803	2006212
ATRK 150T	150	1.20 mm	0,530	2006703
150 ATR 200T	200	1.20 mm	2,338	2006213
ATRK 200T	200	1.20 mm	0,775	2006704

H = YÜKSEKLİK = HEIGHT / W = GENİŞLİK = WIDTH / T = KALINLIK = THICKNESS

H ATR 100 T

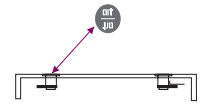
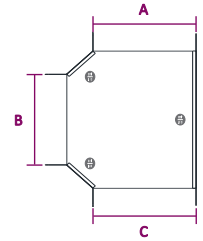
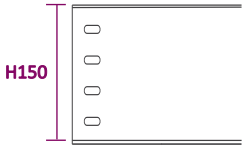
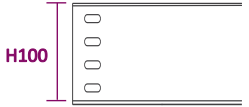
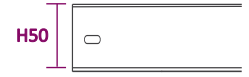

Dönüşlerde "A-B-C" ölçüleri esit olarak üretilmektedir. İsteğe bağlı olarak farklı ölçülerde üretim yapılır. Bends are produced same dimension for "A-B-C" as well as we can produce special dimensions regarding your inquiry.

ARTIM METAL ELEKTRİK A.Ş.

* Farklı kalınlık ve ölçülerde üretim yapılabılır.
* Malzeme ağırlıkları yaklaşık değerlerdir, ± %10 değişiklik gösterebilir.
* Malzeme kalınlık toleransı ± %10 dur.
* Lütfen siparişlerinizde sipariş kodu veya ürün kodu ve Kaplama şeklini belirtiniz.

* We can produce cable trays different thickness and dimensions
* Cable trays are shown approximately weight, they could change ± %10 difference.
* Cable trays thickness tolerances are shown ± %10 .
* Please indicate order code and coating type in your orders.

ATR SERIES

T BAGLANTI

T BEND

SICAK DALDIRMA (SD)

HOT DIP GALVANIZED (HDG)

TS EN ISO 1461



H50 = Tek delikli

H50 = One hole

H75 = İki delikli

H75 = Two holes

H100 = H150 = Dört delikli

H100 = H150 = Four holes



H50

Sipariş Kodu Order Code	W (mm)	T (mm)	Ağırlık (kg/ad) Weight (kg/pcs)	Barkod Kodu Barcode Code
50 ATR 050T	50	1.50 mm	0,332	2006200
ATRK 050T	50	1.50 mm	0,154	2006700
50 ATR 075T	75	1.50 mm	0,498	2006201
ATRK 075T	75	1.50 mm	0,231	2006701
50 ATR 100T	100	1.50 mm	0,788	2006202
ATRK 100T	100	1.50 mm	0,319	2006702
50 ATR 150T	150	1.50 mm	0,982	2006203
ATRK 150T	150	1.50 mm	0,583	2006703
50 ATR 200T	200	1.50 mm	1,322	2006204
ATRK 200T	200	1.50 mm	0,853	2006704

H75

Sipariş Kodu Order Code	W (mm)	T (mm)	Ağırlık (kg/ad) Weight (kg/pcs)	Barkod Kodu Barcode Code
75 ATR 075T	75	1.50 mm	0,734	2006205
ATRK 075T	75	1.50 mm	0,231	2006701
75 ATR 100T	100	1.50 mm	0,978	2006206
ATRK 100T	100	1.50 mm	0,319	2006702
75 ATR 150T	150	1.50 mm	1,172	2006207
ATRK 150T	150	1.50 mm	0,583	2006703
75 ATR 200T	200	1.50 mm	1,520	2006208
ATRK 200T	200	1.50 mm	0,853	2006704

H100

Sipariş Kodu Order Code	W (mm)	T (mm)	Ağırlık (kg/ad) Weight (kg/pcs)	Barkod Kodu Barcode Code
100 ATR 100T	100	1.50 mm	1,129	2006209
ATRK 100T	100	1.50 mm	0,319	2006702
100 ATR 150T	150	1.50 mm	1,322	2006210
ATRK 150T	150	1.50 mm	0,583	2006703
100 ATR 200T	200	1.50 mm	1,715	2006211
ATRK 200T	200	1.50 mm	0,853	2006704

H150

Sipariş Kodu Order Code	W (mm)	T (mm)	Ağırlık (kg/ad) Weight (kg/pcs)	Barkod Kodu Barcode Code
150 ATR 150T	150	1.50 mm	1,983	2006212
ATRK 150T	150	1.50 mm	0,583	2006703
150 ATR 200T	200	1.50 mm	2,572	2006213
ATRK 200T	200	1.50 mm	0,853	2006704

H = YÜKSEKLİK = HEIGHT / W = GENİŞLİK = WIDTH / T = KALINLIK = THICKNESS

H ATR 100 T

Yükseklik Kanal Tipi Genişlik Modül
Height Type Width Module

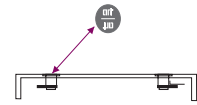
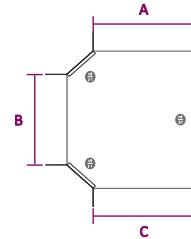
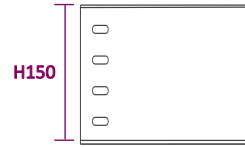
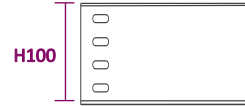
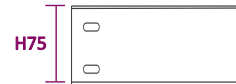
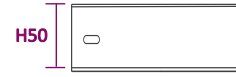

Dönüşlerde "A-B-C" ölçüleri esit olarak üretilmektedir. İsteğe bağlı olarak farklı ölçülerde üretim yapılır. Bends are produced same dimension for "A-B-C" as well as we can produce special dimensions regarding your inquiry.

* Farklı kalınlık ve ölçülerde üretim yapıla bilinir.
* Malzeme ağırlıkları yaklaşık değerlerdir, ± %10 değişiklik gösterebilir.
* Malzeme kalınlık toleransı ± %10 dur.
* Lütfen siparişlerinizde sipariş kodu veya ürün kodu ve Kaplama şeklini belirtiniz.

* We can produce cable trays different thickness and dimensions
* Cable trays are shown approximately weight, they could change ± %10 difference.
* Cable trays thickness tolerances are shown ± %10 .
* Please indicate order code and coating type in your orders.

ATR SERIES

DÖRTLÜ BAGLANTI

FOUR WAY CROSSING

PREGALVANİZ (PG)
PREGALVANİZED (PG)
TS EN 10346



H50 = Tek delikli
H50 = One hole

H75 = İki delikli
H75 = Two holes

H100 = H150 = Dört delikli
H100 = H150 = Four holes



H50

Sipariş Kodu Order Code	W (mm)	T (mm)	Ağırlık (kg/ad) Weight (kg/pcs)	Barkod Kodu Barcode Code
50 ATR 050D	50	1.20 mm	0,342	2006300
ATRK 050D	50	1.20 mm	0,170	2006800
50 ATR 075D	75	1.20 mm	0,513	2006301
ATRK 075D	75	1.20 mm	0,255	2006801
50 ATR 100D	100	1.20 mm	0,828	2006302
ATRK 100D	100	1.20 mm	0,340	2006802
50 ATR 150D	150	1.20 mm	0,909	2006303
ATRK 150D	150	1.20 mm	0,595	2006803
50 ATR 200D	200	1.20 mm	1,303	2006304
ATRK 200D	200	1.20 mm	0,805	2006804

H75

Sipariş Kodu Order Code	W (mm)	T (mm)	Ağırlık (kg/ad) Weight (kg/pcs)	Barkod Kodu Barcode Code
75 ATR 075D	75	1.20 mm	0,756	2006305
ATRK 075D	75	1.20 mm	0,255	2006801
75 ATR 100D	100	1.20 mm	1,008	2006306
ATRK 100D	100	1.20 mm	0,340	2006802
75 ATR 150D	150	1.20 mm	1,166	2006307
ATRK 150D	150	1.20 mm	0,595	2006803
75 ATR 200D	200	1.20 mm	1,487	2006308
ATRK 200D	200	1.20 mm	0,805	2006804

H100

Sipariş Kodu Order Code	W (mm)	T (mm)	Ağırlık (kg/ad) Weight (kg/pcs)	Barkod Kodu Barcode Code
100 ATR 100D	100	1.20 mm	1,163	2006309
ATRK 100D	100	1.20 mm	0,340	2006802
100 ATR 150D	150	1.20 mm	1,296	2006310
ATRK 150D	150	1.20 mm	0,595	2006803
100 ATR 200D	200	1.20 mm	1,634	2006311
ATRK 200D	200	1.20 mm	0,805	2006804

H150

Sipariş Kodu Order Code	W (mm)	T (mm)	Ağırlık (kg/ad) Weight (kg/pcs)	Barkod Kodu Barcode Code
150 ATR 150D	150	1.20 mm	1,944	2006312
ATRK 150D	150	1.20 mm	0,595	2006803
150 ATR 200D	200	1.20 mm	2,451	2006313
ATRK 200D	200	1.20 mm	0,805	2006804

H = YÜKSEKLİK = HEIGHT / W = GENİŞLİK = WIDTH / T = KALINLIK = THICKNESS

H ATR 100 D
Yükseklik Kanal Tipi Genişlik Modül
Height Type Width Module

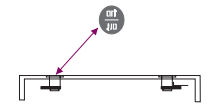
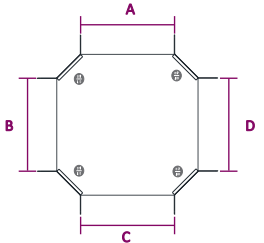
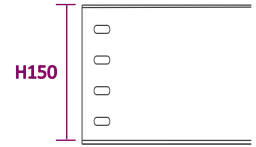
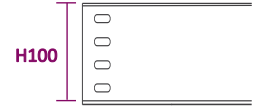
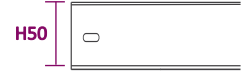

Dönüşlerde "A-B-C-D" ölçüleri esit olarak üretilmektedir. İsteğe bağlı olarak farklı ölçülerde üretim yapılır. Bends are produced same dimension for "A-B-C-D" as well as we can produce special dimensions regarding your inquiry.

ARTIM METAL ELEKTRİK A.Ş.

* Farklı kalınlık ve ölçülerde üretim yapılabılır.
* Malzeme ağırlıkları yaklaşık değerlerdir, ± %10 değişiklik gösterebilir.
* Malzeme kalınlık toleransı ± %10 dur.
* Lütfen siparişlerinizde sipariş kodu veya ürün kodu ve Kaplama şeklini belirtiniz.

* We can produce cable trays different thickness and dimensions
* Cable trays are shown approximately weight, they could change ± %10 difference.
* Cable trays thickness tolerances are shown ± %10 .
* Please indicate order code and coating type in your orders.

ATR SERIES

DÖRTLÜ BAGLANTI

FOUR WAY CROSSING

SICAK DALDIRMA (SD)

HOT DIP GALVANIZED (HDG)

TS EN ISO 1461



H50 = Tek delikli
H50 = One hole

H75 = İki delikli
H75 = Two holes

H100 = H150 = Dört delikli
H100 = H150 = Four holes



H50

Sipariş Kodu Order Code	W (mm)	T (mm)	Ağırlık (kg/ad) Weight (kg/pcs)	Barkod Kodu Barcode Code
50 ATR 050D	50	1.50 mm	0,376	2006300
ATRK 050D	50	1.50 mm	0,187	2006800
50 ATR 075D	75	1.50 mm	0,564	2006301
ATRK 075D	75	1.50 mm	0,281	2006801
50 ATR 100D	100	1.50 mm	0,911	2006302
ATRK 100D	100	1.50 mm	0,374	2006802
50 ATR 150D	150	1.50 mm	1,000	2006303
ATRK 150D	150	1.50 mm	0,655	2006803
50 ATR 200D	200	1.50 mm	1,433	2006304
ATRK 200D	200	1.50 mm	0,886	2006804

H75

Sipariş Kodu Order Code	W (mm)	T (mm)	Ağırlık (kg/ad) Weight (kg/pcs)	Barkod Kodu Barcode Code
75 ATR 075D	75	1.50 mm	0,832	2006305
ATRK 075D	75	1.50 mm	0,281	2006801
75 ATR 100D	100	1.50 mm	1,109	2006306
ATRK 100D	100	1.50 mm	0,374	2006802
75 ATR 150D	150	1.50 mm	1,283	2006307
ATRK 150D	150	1.50 mm	0,655	2006803
75 ATR 200D	200	1.50 mm	1,636	2006308
ATRK 200D	200	1.50 mm	0,886	2006804

H100

Sipariş Kodu Order Code	W (mm)	T (mm)	Ağırlık (kg/ad) Weight (kg/pcs)	Barkod Kodu Barcode Code
100 ATR 100D	100	1.50 mm	1,279	2006309
ATRK 100D	100	1.50 mm	0,374	2006802
100 ATR 150D	150	1.50 mm	1,426	2006310
ATRK 150D	150	1.50 mm	0,655	2006803
100 ATR 200D	200	1.50 mm	1,797	2006311
ATRK 200D	200	1.50 mm	0,886	2006804

H150

Sipariş Kodu Order Code	W (mm)	T (mm)	Ağırlık (kg/ad) Weight (kg/pcs)	Barkod Kodu Barcode Code
150 ATR 150D	150	1.50 mm	2,138	2006312
ATRK 150D	150	1.50 mm	0,655	2006803
150 ATR 200D	200	1.50 mm	2,696	2006313
ATRK 200D	200	1.50 mm	0,886	2006804

H = YÜKSEKLİK = HEIGHT / W = GENİŞLİK = WIDTH / T = KALINLIK = THICKNESS

H ATR 100 D

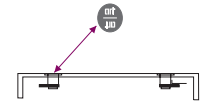
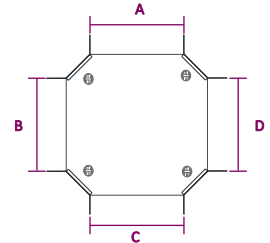
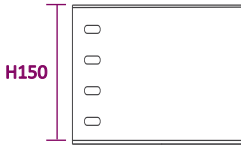
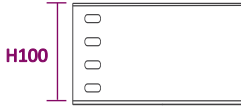
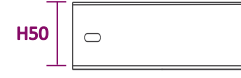

Dönüşlerde "A-B-C-D" ölçüleri esit olarak üretilmektedir. İsteğe bağlı olarak farklı ölçülerde üretim yapılır. Bends are produced same dimension for "A-B-C-D" as well as we can produce special dimensions regarding your inquiry.

* Farklı kalınlık ve ölçülerde üretim yapıla bilinir.
* Malzeme ağırlıkları yaklaşık değerlerdir, ± %10 değişiklik gösterebilir.
* Malzeme kalınlık toleransı ± %10 dur.
* Lütfen siparişlerinizde sipariş kodu veya ürün kodu ve Kaplama şeklini belirtiniz.

* We can produce cable trays different thickness and dimensions
* Cable trays are shown approximately weight, they could change ± %10 difference.
* Cable trays thickness tolerances are shown ± %10 .
* Please indicate order code and coating type in your orders.

ATR SERIES

REDÜKSİYON

REDUCING ANGLES

PREGALVANIZ (PG)
PREGALVANIZED (PG)
TS EN 10346



H50 = Tek delikli
H50 = One hole
H75 = İki delikli
H75 = Two holes

H100 = H150 = Dört delikli
H100 = H150 = Four holes

H50 x H50

Sipariş Kodu Order Code	W (mm)	T (mm)	Ağırlık (kg/ad) Weight (kg/pcs)	Barkod Kodu Barcode Code
ATR R1	50x75	1.20 mm	0,717	2006500

H50 x H75

Sipariş Kodu Order Code	W (mm)	T (mm)	Ağırlık (kg/ad) Weight (kg/pcs)	Barkod Kodu Barcode Code
ATR R2	75x75	1.20 mm	0,865	2006501
ATR R3	75x100	1.20 mm	0,925	2006502

H75 x H75

Sipariş Kodu Order Code	W (mm)	T (mm)	Ağırlık (kg/ad) Weight (kg/pcs)	Barkod Kodu Barcode Code
ATR R4	75x100	1.20 mm	0,987	2006503

H75 x H100

Sipariş Kodu Order Code	W (mm)	T (mm)	Ağırlık (kg/ad) Weight (kg/pcs)	Barkod Kodu Barcode Code
ATR R5	75x100	1.20 mm	1,148	2006504
ATR R6	100x100	1.20 mm	1,252	2006505
ATR R7	100x150	1.20 mm	1,257	2006506

H100 x H100

Sipariş Kodu Order Code	W (mm)	T (mm)	Ağırlık (kg/ad) Weight (kg/pcs)	Barkod Kodu Barcode Code
ATR R8	100x150	1.20 mm	1,395	2006507
ATR R9	100x200	1.20 mm	1,432	2006508
ATR R10	150x200	1.20 mm	1,631	2006509

H100 x H150

Sipariş Kodu Order Code	W (mm)	T (mm)	Ağırlık (kg/ad) Weight (kg/pcs)	Barkod Kodu Barcode Code
ATR R11	150x150	1.20 mm	1,486	2006510
ATR R12	150x200	1.20 mm	1,757	2006511

H150 x H150

Sipariş Kodu Order Code	W (mm)	T (mm)	Ağırlık (kg/ad) Weight (kg/pcs)	Barkod Kodu Barcode Code
ATR R13	150x200	1.20 mm	1,839	2006512

H = YÜKSEKLİK = HEIGHT / W = GENİŞLİK = WIDTH / T = KALINLIK = THICKNESS

1.20 mm

Sipariş Kodu Order Code	W (mm)	T (mm)	Ağırlık (kg/ad) Weight (kg/pcs)	Barkod Kodu Barcode Code
ATR R1 - K	50x75	1.20 mm	0,188	2006551
ATR R2 - K	75x75	1.20 mm	0,198	2006552
ATR R3 - K	75x100	1.20 mm	0,226	2006553
ATR R6 - K	100x100	1.20 mm	0,230	2006554
ATR R7 - K	100x150	1.20 mm	0,282	2006555
ATR R10 - K	100x200	1.20 mm	0,414	2006556
ATR R11 - K	150x200	1.20 mm	0,424	2006557

H = YÜKSEKLİK = HEIGHT / W = GENİŞLİK = WIDTH / T = KALINLIK = THICKNESS

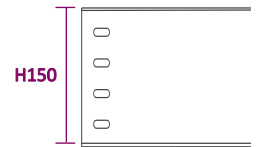
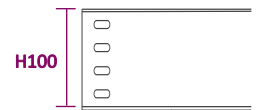
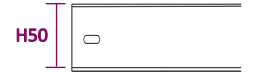
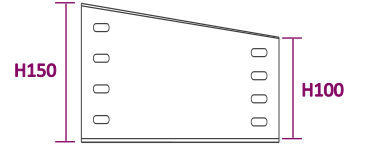
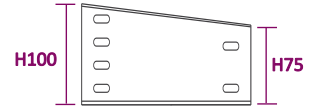
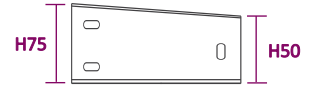
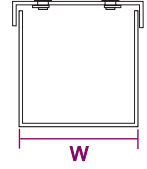
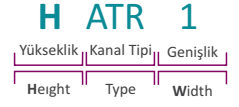

ARTIM METAL ELEKTRİK A.Ş.

* Farklı kalınlık ve ölçülerde üretim yapılabılır.
* Malzeme ağırlıkları yaklaşık değerlerdir, ± %10 değişiklik gösterebilir.
* Malzeme kalınlık toleransı ± %10 dur.
* Lütfen siparişlerinizde sipariş kodu veya ürün kodu ve Kaplama şeklini belirtiniz.

* We can produce cable trays different thickness and dimensions
* Cable trays are shown approximately weight, they could change ± %10 difference.
* Cable trays thickness tolerances are shown ± %10 .
* Please indicate order code and coating type in your orders.

ATR SERIES

REDÜKSİYON

REDUCING ANGLES

SICAK DALDIRMA (SD)

HOT DIP GALVANIZED (HDG)

TS EN ISO 1461



H50 = Tek delikli
H50 = One hole

H75 = İki delikli
H75 = Two holes

H100 = H150 = Dört delikli
H100 = H150 = Four holes



H50 x H50

Sipariş Kodu Order Code	W (mm)	T (mm)	Ağırlık (kg/ad) Weight (kg/pcs)	Barkod Kodu Barcode Code
ATR R1	50x75	1.20 mm	0,789	2006500

H50 x H75

Sipariş Kodu Order Code	W (mm)	T (mm)	Ağırlık (kg/ad) Weight (kg/pcs)	Barkod Kodu Barcode Code
ATR R2	75x75	1.20 mm	0,952	2006501
ATR R3	75x100	1.20 mm	1,018	2006502

H75 x H75

Sipariş Kodu Order Code	W (mm)	T (mm)	Ağırlık (kg/ad) Weight (kg/pcs)	Barkod Kodu Barcode Code
ATR R4	75x100	1.20 mm	1,086	2006503

H75 x H100

Sipariş Kodu Order Code	W (mm)	T (mm)	Ağırlık (kg/ad) Weight (kg/pcs)	Barkod Kodu Barcode Code
ATR R5	75x100	1.20 mm	1,263	2006504
ATR R6	100x100	1.20 mm	1,377	2006505
ATR R7	100x150	1.20 mm	1,383	2006506

H100 x H100

Sipariş Kodu Order Code	W (mm)	T (mm)	Ağırlık (kg/ad) Weight (kg/pcs)	Barkod Kodu Barcode Code
ATR R8	100x150	1.20 mm	1,535	2006507
ATR R9	100x200	1.20 mm	1,575	2006508
ATR R10	150x200	1.20 mm	1,794	2006509

H100 x H150

Sipariş Kodu Order Code	W (mm)	T (mm)	Ağırlık (kg/ad) Weight (kg/pcs)	Barkod Kodu Barcode Code
ATR R11	150x150	1.20 mm	1,635	2006510
ATR R12	150x200	1.20 mm	1,933	2006511

H150 x H150

Sipariş Kodu Order Code	W (mm)	T (mm)	Ağırlık (kg/ad) Weight (kg/pcs)	Barkod Kodu Barcode Code
ATR R13	150x200	1.20 mm	2,023	2006512

H = YÜKSEKLİK = HEIGHT / W = GENİŞLİK = WIDTH / T = KALINLIK = THICKNESS

1.20 mm

Sipariş Kodu Order Code	W (mm)	T (mm)	Ağırlık (kg/ad) Weight (kg/pcs)	Barkod Kodu Barcode Code
ATR R1 - K	50x75	1.20 mm	0,207	2006551
ATR R2 - K	75x75	1.20 mm	0,218	2006552
ATR R3 - K	75x100	1.20 mm	0,249	2006553
ATR R6 - K	100x100	1.20 mm	0,253	2006554
ATR R7 - K	100x150	1.20 mm	0,310	2006555
ATR R10 - K	100x200	1.20 mm	0,455	2006556
ATR R11 - K	150x200	1.20 mm	0,466	2006557

H = YÜKSEKLİK = HEIGHT / W = GENİŞLİK = WIDTH / T = KALINLIK = THICKNESS

H ATR 1

Yükseklik | Kanal Tipi | Genişlik
Height | Type | Width

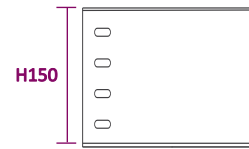
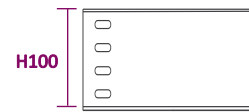
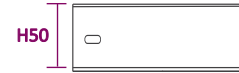
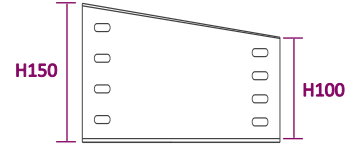
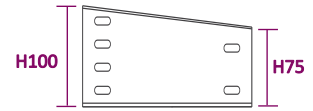
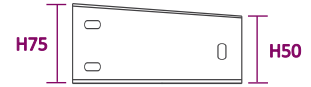
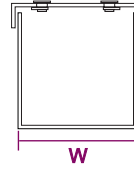

* Farklı kalınlık ve ölçülerde üretim yapılabılır.
* Malzeme ağırlıkları yaklaşık değerlerdir, \pm %10 değişiklik gösterebilir.
* Malzeme kalınlık toleransı \pm %10 dur.
* Lütfen siparişlerinizde sipariş kodu veya ürün kodu ve kaplama şeklini belirtiniz.

* We can produce cable trays different thickness and dimensions
* Cable trays are shown approximately weight, they could change \pm %10 difference.
* Cable trays thickness tolerances are shown \pm %10 .
* Please indicate order code and coating type in your orders.

ATR SERIES

İÇ BÜKEY DÖNÜS (SABIT)

CONSTANT INSIDE VERTICAL BENDS

PREGALVANIZ (PG)
PREGALVANIZED (PG)
TS EN 10346



H50 = Tek delikli
H50 = One hole

H75 = İki delikli
H75 = Two holes

H100 = H150 = Dört delikli
H100 = H150 = Four holes

H50

Sipariş Kodu Order Code	W (mm)	T (mm)	Ağırlık (kg/ad) Weight (kg/pcs)	Barkod Kodu Barcode Code
50 ATR 050B S1	50	1.20 mm	1,235	2006400
ATRK 050B S1	50	1.20 mm	0,440	2006900
50 ATR 075B S1	75	1.20 mm	1,852	2006401
ATRK 075B S1	75	1.20 mm	0,660	2006901
50 ATR 100B S1	100	1.20 mm	1,575	2006402
ATRK 100B S1	100	1.20 mm	0,755	2006902
50 ATR 150B S1	150	1.20 mm	1,975	2006403
ATRK 150B S1	150	1.20 mm	1,130	2006903
50 ATR 200B S1	200	1.20 mm	2,265	2006404
ATRK 200B S1	200	1.20 mm	1,385	2006904

H75

Sipariş Kodu Order Code	W (mm)	T (mm)	Ağırlık (kg/ad) Weight (kg/pcs)	Barkod Kodu Barcode Code
75 ATR 07B S1	75	1.20 mm	1,388	2006405
ATRK 075B S1	75	1.20 mm	0,660	2006901
75 ATR 100B S1	100	1.20 mm	1,850	2006406
ATRK 100B S1	100	1.20 mm	0,755	2006902
75 ATR 150B S1	150	1.20 mm	2,250	2006407
ATRK 150B S1	150	1.20 mm	1,130	2006903
75 ATR 200B S1	200	1.20 mm	2,535	2006408
ATRK 200B S1	200	1.20 mm	1,385	2006904

H100

Sipariş Kodu Order Code	W (mm)	T (mm)	Ağırlık (kg/ad) Weight (kg/pcs)	Barkod Kodu Barcode Code
100 ATR 100B S1	100	1.20 mm	2,050	2006409
ATRK 100B S1	100	1.20 mm	0,755	2006902
100 ATR 150B S1	150	1.20 mm	2,455	2006410
ATRK 150B S1	150	1.20 mm	1,130	2006903
100 ATR 200B S1	200	1.20 mm	2,745	2006411
ATRK 200B S1	200	1.20 mm	1,385	2006904

H150

Sipariş Kodu Order Code	W (mm)	T (mm)	Ağırlık (kg/ad) Weight (kg/pcs)	Barkod Kodu Barcode Code
150 ATR 150B S1	150	1.20 mm	3,682	2006412
ATRK 150B S1	150	1.20 mm	1,130	2006903
150 ATR 200B S1	200	1.20 mm	4,117	2006413
ATRK 200B S1	200	1.20 mm	1,385	2006904

H = YÜKSEKLİK = HEIGHT / W = GENİŞLİK = WIDTH / T = KALINLIK = THICKNESS

H ATR 100 B S1

Yükseklik Kanal Tipi Genişlik Modül
Height Type Width Module

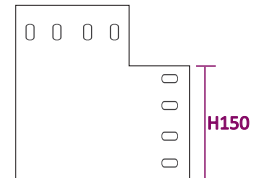
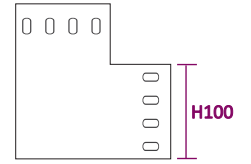
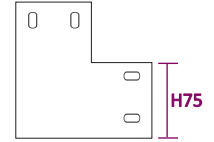
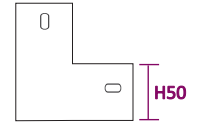
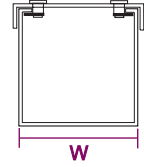

ARTIM METAL ELEKTRİK A.Ş.

* Farklı kalınlık ve ölçülerde üretim yapılabılır.
* Malzeme ağırlıkları yaklaşık değerlerdir, ± %10 değişiklik gösterebilir.
* Malzeme kalınlık toleransı ± %10 dur.
* Lütfen siparişlerinizde sipariş kodu veya ürün kodu ve Kaplama şeklini belirtiniz.

* We can produce cable trays different thickness and dimensions
* Cable trays are shown approximately weight, they could change ± %10 difference.
* Cable trays thickness tolerances are shown ± %10 .
* Please indicate order code and coating type in your orders.

ATR SERIES

İÇ BÜKEY DÖNÜS (SABIT)

CONSTANT INSIDE VERTICAL BENS

SICAK DALDIRMA (SD)

HOT DIP GALVANIZED (HDG)

TS EN ISO 1461



H50 = Tek delikli
H50 = One hole

H75 = İki delikli
H75 = Two holes

H100 = H150 = Dört delikli
H100 = H150 = Four holes

H50

Sipariş Kodu Order Code	W (mm)	T (mm)	Ağırlık (kg/ad) Weight (kg/pcs)	Barkod Kodu Barcode Code
50 ATR 050B S1	50	1.50 mm	1,359	2006400
ATRK 050B S1	50	1.50 mm	0,484	2006900
50 ATR 075B S1	75	1.50 mm	2,037	2006401
ATRK 075B S1	75	1.50 mm	0,726	2006901
50 ATR 100B S1	100	1.50 mm	1,733	2006402
ATRK 100B S1	100	1.50 mm	0,831	2006902
50 ATR 150B S1	150	1.50 mm	2,173	2006403
ATRK 150B S1	150	1.50 mm	1,243	2006903
50 ATR 200B S1	200	1.50 mm	2,492	2006404
ATRK 200B S1	200	1.50 mm	1,524	2006904

H75

Sipariş Kodu Order Code	W (mm)	T (mm)	Ağırlık (kg/ad) Weight (kg/pcs)	Barkod Kodu Barcode Code
75 ATR 07B S1	75	1.50 mm	1,527	2006405
ATRK 075B S1	75	1.50 mm	0,726	2006901
75 ATR 100B S1	100	1.50 mm	2,035	2006406
ATRK 100B S1	100	1.50 mm	0,831	2006902
75 ATR 150B S1	150	1.50 mm	2,475	2006407
ATRK 150B S1	150	1.50 mm	1,243	2006903
75 ATR 200B S1	200	1.50 mm	2,789	2006408
ATRK 200B S1	200	1.50 mm	1,524	2006904

H100

Sipariş Kodu Order Code	W (mm)	T (mm)	Ağırlık (kg/ad) Weight (kg/pcs)	Barkod Kodu Barcode Code
100 ATR 100B S1	100	1.50 mm	2,255	2006409
ATRK 100B S1	100	1.50 mm	0,831	2006902
100 ATR 150B S1	150	1.50 mm	2,701	2006410
ATRK 150B S1	150	1.50 mm	1,243	2006903
100 ATR 200B S1	200	1.50 mm	3,020	2006411
ATRK 200B S1	200	1.50 mm	1,524	2006904

H150

Sipariş Kodu Order Code	W (mm)	T (mm)	Ağırlık (kg/ad) Weight (kg/pcs)	Barkod Kodu Barcode Code
150 ATR 150B S1	150	1.50 mm	4,050	2006412
ATRK 150B S1	150	1.50 mm	1,243	2006903
150 ATR 200B S1	200	1.50 mm	4,529	2006413
ATRK 200B S1	200	1.50 mm	1,524	2006904

H = YÜKSEKLİK = HEIGHT / W = GENİŞLİK = WIDTH / T = KALINLIK = THICKNESS

H ATR 100 B S1

Yükseklik Kanal Tipi Genişlik Modül
Height Type Width Module

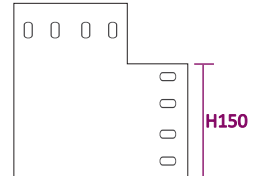
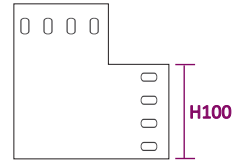
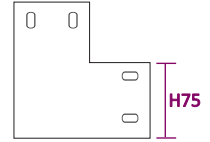
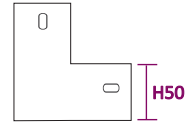
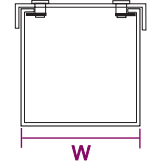

* Farklı kalınlık ve ölçülerde üretim yapıla bilinir.
* Malzeme ağırlıkları yaklaşık değerlerdir, ± %10 değişiklik gösterebilir.
* Malzeme kalınlık toleransı ± %10 dur.
* Lütfen siparişlerinizde sipariş kodu veya ürün kodu ve Kaplama şeklini belirtiniz.

* We can produce cable trays different thickness and dimensions
* Cable trays are shown approximately weight, they could change ± %10 difference.
* Cable trays thickness tolerances are shown ± %10 .
* Please indicate order code and coating type in your orders.

ATR SERIES

DIS BÜKEY DÖNÜS (SABIT)

CONSTANT OUTSIDE VERTICAL BENDS

PREGALVANIZ (PG)
PREGALVANIZED (PG)
TS EN 10346



H50 = Tek delikli
H50 = One hole

H75 = İki delikli
H75 = Two holes

H100 = H150 = Dört delikli
H100 = H150 = Four holes

H50

Sipariş Kodu Order Code	W (mm)	T (mm)	Ağırlık (kg/ad) Weight (kg/pcs)	Barkod Kodu Barcode Code
50 ATR 050B S2	50	1.20 mm	1,235	2006450
ATRK 050B S2	50	1.20 mm	0,440	2006950
50 ATR 075B S2	75	1.20 mm	1,852	2006451
ATRK 075B S2	75	1.20 mm	0,660	2006951
50 ATR 100B S2	100	1.20 mm	1,575	2006452
ATRK 100B S2	100	1.20 mm	0,755	2006952
50 ATR 150B S2	150	1.20 mm	1,975	2006453
ATRK 150B S2	150	1.20 mm	1,130	2006953
50 ATR 200B S2	200	1.20 mm	2,265	2006454
ATRK 200B S2	200	1.20 mm	1,385	2006954

H75

Sipariş Kodu Order Code	W (mm)	T (mm)	Ağırlık (kg/ad) Weight (kg/pcs)	Barkod Kodu Barcode Code
75 ATR 07B S2	75	1.20 mm	1,388	2006455
ATRK 075B S2	75	1.20 mm	0,660	2006951
75 ATR 100B S2	100	1.20 mm	1,850	2006456
ATRK 100B S2	100	1.20 mm	0,755	2006952
75 ATR 150B S2	150	1.20 mm	2,250	2006457
ATRK 150B S2	150	1.20 mm	1,130	2006953
75 ATR 200B S2	200	1.20 mm	2,535	2006458
ATRK 200B S2	200	1.20 mm	1,385	2006954

H100

Sipariş Kodu Order Code	W (mm)	T (mm)	Ağırlık (kg/ad) Weight (kg/pcs)	Barkod Kodu Barcode Code
100 ATR 100B S2	100	1.20 mm	2,050	2006459
ATRK 100B S2	100	1.20 mm	0,755	2006952
100 ATR 150B S2	150	1.20 mm	2,455	2006460
ATRK 150B S2	150	1.20 mm	1,130	2006953
100 ATR 200B S2	200	1.20 mm	2,745	2006461
ATRK 200B S2	200	1.20 mm	1,385	2006954

H150

Sipariş Kodu Order Code	W (mm)	T (mm)	Ağırlık (kg/ad) Weight (kg/pcs)	Barkod Kodu Barcode Code
150 ATR 150B S2	150	1.20 mm	3,682	2006462
ATRK 150B S2	150	1.20 mm	1,130	2006953
150 ATR 200B S2	200	1.20 mm	4,117	2006463
ATRK 200B S2	200	1.20 mm	1,385	2006954

H = YÜKSEKLİK = HEIGHT / W = GENİŞLİK = WIDTH / T = KALINLIK = THICKNESS

H ATR 100 B S2

Yükseklik Kanal Tipi Genişlik Modül
Height Type Width Module

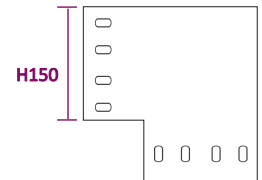
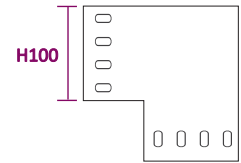
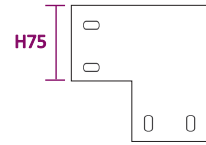
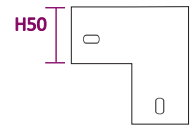
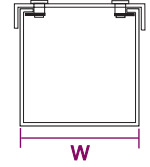

ARTIM METAL ELEKTRİK A.Ş.

* Farklı kalınlık ve ölçülerde üretim yapılabılır.
* Malzeme ağırlıkları yaklaşık değerlerdir, ± %10 değişiklik gösterebilir.
* Malzeme kalınlık toleransı ± %10 dur.
* Lütfen siparişlerinizde sipariş kodu veya ürün kodu ve Kaplama şeklini belirtiniz.

* We can produce cable trays different thickness and dimensions
* Cable trays are shown approximately weight, they could change ± %10 difference.
* Cable trays thickness tolerances are shown ± %10.
* Please indicate order code and coating type in your orders.

ATR SERIES

DIS BÜKEY DÖNÜS (SABIT)

CONSTANT OUTSIDE VERTICAL BENS

SICAK DALDIRMA (SD)

HOT DIP GALVANIZED (HDG)

TS EN ISO 1461



H50 = Tek delikli
H50 = One hole

H75 = İki delikli
H75 = Two holes

H100 = H150 = Dört delikli
H100 = H150 = Four holes

H50

Sipariş Kodu Order Code	W (mm)	T (mm)	Ağırlık (kg/ad) Weight (kg/pcs)	Barkod Kodu Barcode Code
50 ATR 050B S2	50	1.50 mm	1,359	2006450
ATRK 050B S2	50	1.50 mm	0,484	2006950
50 ATR 075B S2	75	1.50 mm	2,037	2006451
ATRK 075B S2	75	1.50 mm	0,726	2006951
50 ATR 100B S2	100	1.50 mm	1,733	2006452
ATRK 100B S2	100	1.50 mm	0,831	2006952
50 ATR 150B S2	150	1.50 mm	2,173	2006453
ATRK 150B S2	150	1.50 mm	1,243	2006953
50 ATR 200B S2	200	1.50 mm	2,492	2006454
ATRK 200B S2	200	1.50 mm	1,524	2006954

H75

Sipariş Kodu Order Code	W (mm)	T (mm)	Ağırlık (kg/ad) Weight (kg/pcs)	Barkod Kodu Barcode Code
75 ATR 07B S2	75	1.50 mm	1,527	2006455
ATRK 075B S2	75	1.50 mm	0,726	2006951
75 ATR 100B S2	100	1.50 mm	2,035	2006456
ATRK 100B S2	100	1.50 mm	0,831	2006952
75 ATR 150B S2	150	1.50 mm	2,475	2006457
ATRK 150B S2	150	1.50 mm	1,243	2006953
75 ATR 200B S2	200	1.50 mm	2,789	2006458
ATRK 200B S2	200	1.50 mm	1,524	2006954

H100

Sipariş Kodu Order Code	W (mm)	T (mm)	Ağırlık (kg/ad) Weight (kg/pcs)	Barkod Kodu Barcode Code
100 ATR 100B S2	100	1.50 mm	2,255	2006459
ATRK 100B S2	100	1.50 mm	0,831	2006952
100 ATR 150B S2	150	1.50 mm	2,701	2006460
ATRK 150B S2	150	1.50 mm	1,243	2006953
100 ATR 200B S2	200	1.50 mm	3,020	2006461
ATRK 200B S2	200	1.50 mm	1,524	2006954

H150

Sipariş Kodu Order Code	W (mm)	T (mm)	Ağırlık (kg/ad) Weight (kg/pcs)	Barkod Kodu Barcode Code
150 ATR 150B S2	150	1.50 mm	4,050	2006462
ATRK 150B S2	150	1.50 mm	1,243	2006953
150 ATR 200B S2	200	1.50 mm	4,529	2006463
ATRK 200B S2	200	1.50 mm	1,524	2006954

H = YÜKSEKLİK = HEIGHT / W = GENİŞLİK = WIDTH / T = KALINLIK = THICKNESS

H ATR 100 B S2

Yükseklik Kanal Tipi Genişlik Modül
Height Type Width Module

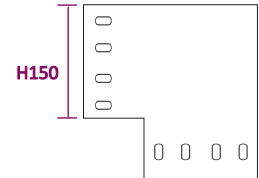
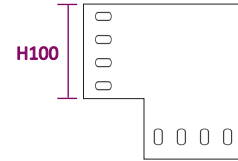
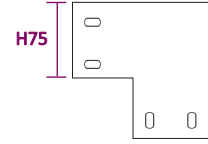
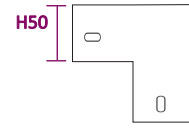
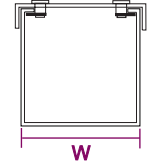

* Farklı kalınlık ve ölçülerde üretim yapılabılır.
* Malzeme ağırlıkları yaklaşık değerlerdir, ± %10 değişiklik gösterebilir.
* Malzeme kalınlık toleransı ± %10 dur.
* Lütfen siparişlerinizde sipariş kodu veya ürün kodu ve Kaplama şeklini belirtiniz.

* We can produce cable trays different thickness and dimensions
* Cable trays are shown approximately weight, they could change ± %10 difference.
* Cable trays thickness tolerances are shown ± %10 .
* Please indicate order code and coating type in your orders.

ATR SERIES

EK ELEMANI

STRAIGHT CONNECTION COUPLER

PREGALVANIZ (PG)
PREGALVANIZED (PG)
TS EN 10346



H50 = Tek delikli
H50 = One hole

H75 = İki delikli
H75 = Two holes

H100 = H150 = Dört delikli
H100 = H150 = Four holes

H50				
Sipariş Kodu Order Code	L (mm)	T (mm)	Ağırlık (kg/ad) Weight (kg/pcs)	Barkod Kodu Barcode Code
50 ATR 1	74 mm	1.20 mm	0,110	2006550

H75				
Sipariş Kodu Order Code	L (mm)	T (mm)	Ağırlık (kg/ad) Weight (kg/pcs)	Barkod Kodu Barcode Code
75 ATR 1	74 mm	1.20 mm	0,154	2006560

H100				
Sipariş Kodu Order Code	L (mm)	T (mm)	Ağırlık (kg/ad) Weight (kg/pcs)	Barkod Kodu Barcode Code
100 ATR 1	74 mm	1.20 mm	0,192	2006570

H150				
Sipariş Kodu Order Code	L (mm)	T (mm)	Ağırlık (kg/ad) Weight (kg/pcs)	Barkod Kodu Barcode Code
150 ATR 1	74 mm	1.20 mm	0,285	2006580

H = YÜKSEKLİK = HEIGHT / T = KALINLIK = THICKNESS / L = BOY = LENGTH

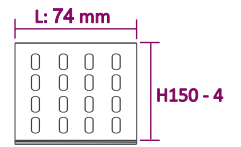
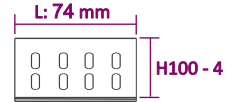
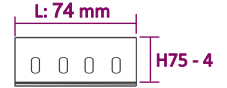
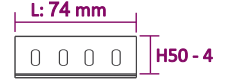

SICAK DALDIRMA (SD)
HOT DIP GALVANIZED (SD)
TS EN ISO 1461

H50				
Sipariş Kodu Order Code	L (mm)	T (mm)	Ağırlık (kg/ad) Weight (kg/pcs)	Barkod Kodu Barcode Code
50 ATR 1	74 mm	1.20 mm	0,121	2006550

H75				
Sipariş Kodu Order Code	L (mm)	T (mm)	Ağırlık (kg/ad) Weight (kg/pcs)	Barkod Kodu Barcode Code
75 ATR 1	74 mm	1.20 mm	0,172	2006560

H100				
Sipariş Kodu Order Code	L (mm)	T (mm)	Ağırlık (kg/ad) Weight (kg/pcs)	Barkod Kodu Barcode Code
100 ATR 1	74 mm	1.20 mm	0,215	2006570

H150				
Sipariş Kodu Order Code	L (mm)	T (mm)	Ağırlık (kg/ad) Weight (kg/pcs)	Barkod Kodu Barcode Code
150 ATR 1	74 mm	1.20 mm	0,319	2006580

H = YÜKSEKLİK = HEIGHT / T = KALINLIK = THICKNESS / L = BOY = LENGTH

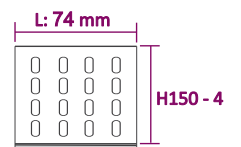
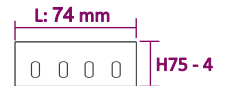

PLASTİK / PLASTIC

Sipariş Kodu Order Code	Ebat Size	T (mm)	Ağırlık (kg/ad) Weight (kg/pcs)	Barkod Kodu Barcode Code
ATR PLS KT	-	1.20 mm	0,030	2006590

ARTIM METAL ELEKTRİK A.Ş.

* Farklı kalınlık ve ölçülerde üretim yapılabılır.
* Malzeme ağırlıkları yaklaşık değerlerdir, \pm %10 değişiklik gösterebilir.
* Malzeme kalınlık toleransı \pm %10 dur.
* Lütfen siparişlerinizde sipariş kodu veya ürün kodu ve Kaplama şeklini belirtiniz.

* We can produce cable trays different thickness and dimensions
* Cable trays are shown approximately weight, they could change \pm %10 difference.
* Cable trays thickness tolerances are shown \pm %10 .
* Please indicate order code and coating type in your orders.